



JRC SCIENCE FOR POLICY REPORT

Best Available Techniques (BAT) Reference Document for the Slaughterhouses, Animal By-products and/or Edible Co-products Industries

*Industrial Emissions Directive 2010/75/EU
(Integrated Pollution
Prevention and Control)*

Karlis, P., Presicce, F., Giner-Santonja, G., Brinkmann, T.,
Roudier, S.

2024

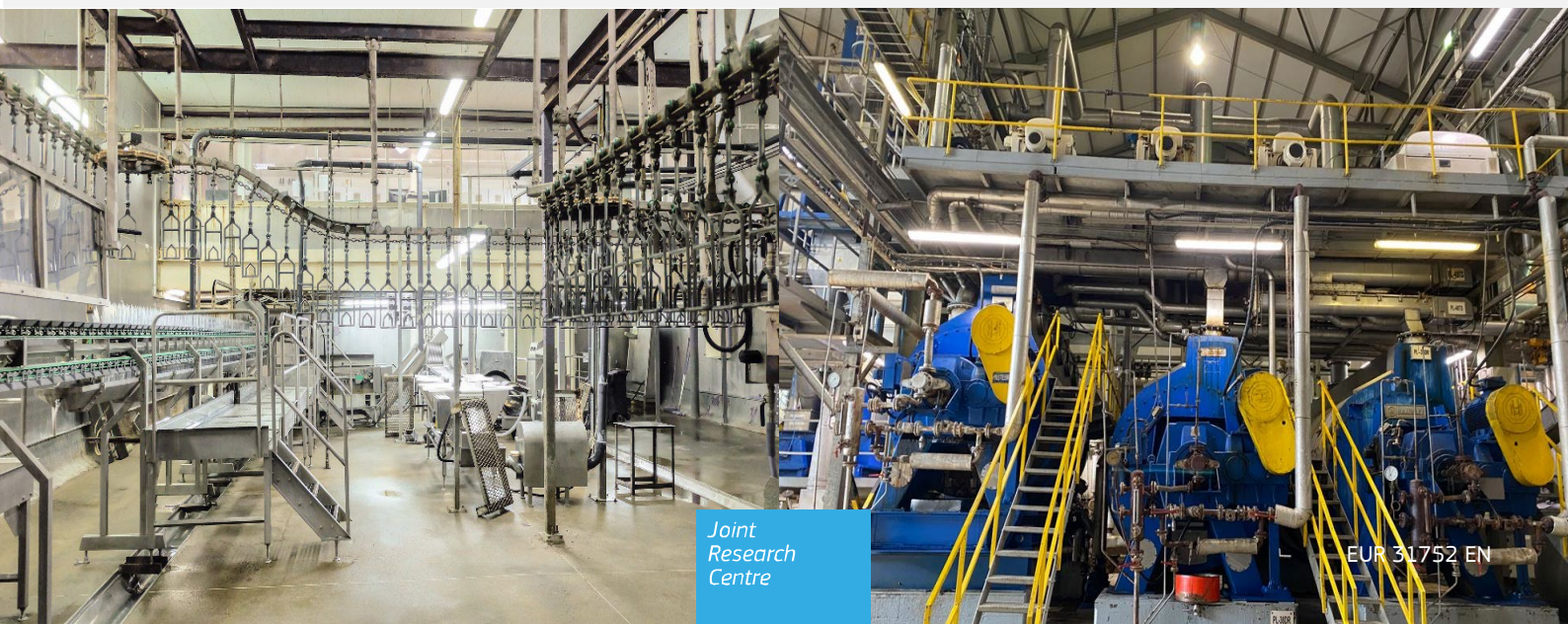

This publication is a Science for Policy report by the Joint Research Centre (JRC), the European Commission's science and knowledge service. It aims to provide evidence-based scientific support to the European policymaking process. The contents of this publication do not necessarily reflect the position or opinion of the European Commission. Neither the European Commission nor any person acting on behalf of the Commission is responsible for the use that might be made of this publication. For information on the methodology and quality underlying the data used in this publication for which the source is neither Eurostat nor other Commission services, users should contact the referenced source. The designations employed and the presentation of material on the maps do not imply the expression of any opinion whatsoever on the part of the European Union concerning the legal status of any country, territory, city or area or of its authorities, or concerning the delimitation of its frontiers or boundaries.

Contact information

Name: European IPPC Bureau, JRC Directorate B - Fair and Sustainable Economy, European Commission
Address: Edificio Expo, c/ Inca Garcilaso 3, E-41092 Seville, Spain
Email: JRC-B5-EIPPCB@ec.europa.eu
Tel.: +34 95 4488 284

EU Science Hub

<https://joint-research-centre.ec.europa.eu>

JRC135916

EUR 31752 EN

PDF ISBN 978-92-68-09712-0 ISSN 1831-9424 [doi:10.2760/18199](https://doi.org/10.2760/18199) KJ-NA-31-752-EN-N

Luxembourg: Publications Office of the European Union, 2024

© European Union, 2024



The reuse policy of the European Commission documents is implemented by the Commission Decision 2011/833/EU of 12 December 2011 on the reuse of Commission documents (OJ L 330, 14.12.2011, p. 39). Unless otherwise noted, the reuse of this document is authorised under the Creative Commons Attribution 4.0 International (CC BY 4.0) licence (<https://creativecommons.org/licenses/by/4.0/>). This means that reuse is allowed provided appropriate credit is given and any changes are indicated.

For any use or reproduction of photos or other material that is not owned by the European Union permission must be sought directly from the copyright holders. The European Union does not own the copyright in relation to the following elements:

- Cover page illustration, Empty butchering workshop poultry with overhead conveyor – poultry processing plant line – production of chicken meat © nskyr2/ stock.adobe.com

How to cite this report: Karlis, P., Presicce, F., Giner Santonja, G., Brinkmann, T. and Roudier, S., *Best Available Techniques (BAT) Reference Document for the Slaughterhouses, Animal By-products and/or Edible Co-products Industries*, Publications Office of the European Union, Luxembourg, 2024, doi:10.2760/18199, JRC135916.

Abstract

The Best Available Techniques (BAT) Reference Document (BREF) for Slaughterhouses, Animal By-products and/or Edible Co-products Industries is part of a series of documents presenting the results of an exchange of information between EU Member States, the industries concerned, non-governmental organisations promoting environmental protection, and the Commission, to draw up, review and – where necessary – update BAT reference documents as required by Article 13(1) of Industrial Emissions Directive 2010/75/EU. This document is published by the European Commission pursuant to Article 13(6) of the Directive.

The BREF for Slaughterhouses, Animal By-products and/or Edible Co-products Industries covers operating slaughterhouses with a carcass production capacity greater than 50 tonnes per day, the processing of animal by-products and/or edible co-products (such as rendering and fat melting, feather processing, fishmeal and fish oil production, blood processing and gelatine manufacturing) and a number of other activities specified in the Scope of the document.

The BREF consists of seven main chapters. General information on the Slaughterhouses, Animal By-products and/or Edible Co-products Industries and their key environmental issues is given in Chapter 1. Chapter 2 provides information and data on generally applied processes and techniques, emission levels and techniques to consider for the determination of BAT across the sector. Chapter 3 provides information and data on applied processes and techniques, emission and consumption levels and techniques to consider in the determination of BAT for slaughterhouses. Chapter 4 provides information and data on applied processes and techniques, emission and consumption levels and techniques to consider in the determination of BAT for installations processing animal by-products and/or edible co-products. Chapter 5 presents the BAT conclusions as defined in Article 3(12) of the Industrial Emissions Directive (2010/75/EU). Chapter 6 provides information on emerging techniques. Concluding remarks and recommendations for future work are presented in Chapter 7.

Acknowledgements

This report was produced by the European Integrated Pollution Prevention and Control Bureau (EIPPCB) at the European Commission's Joint Research Centre – Directorate B: Fair and Sustainable Economy under the supervision of Serge Roudier (Head of the EIPPCB), Alejandro Villanueva (Deputy Head of the Circular Economy and Sustainable Industry Unit) and Caroline Lambert (Head of the Circular Economy and Sustainable Industry Unit).

The authors of this BREF were Panagiotis Karlis, Francesco Presicce, German Giner-Santonja, Thomas Brinkmann and Serge Roudier.

This report was drawn up in the framework of the implementation of the Industrial Emissions Directive (2010/75/EU) and it is the result of the exchange of information provided for in Article 13 of the Directive.

Major contributors of information were:

- among EU Member States: Austria, Belgium, Czechia, Germany, Denmark, Spain, Finland, France, Hungary, Ireland, Italy, Poland, Portugal, Sweden, Slovakia and the United Kingdom (until 31/01/2020);
- among EEA countries: Norway;
- among industry: AVEC (Association of Poultry Processors and Poultry Trade in EU countries), CEFIC (European Chemical Industry Council), CLITRAVI (Liason Centre for the Meat Processing Industry in the European Union), EFPRA (European Fat Processors and Renderers Association), European Fishmeal (European fishmeal and fish oil producers), UECEV (European Livestock and Meat Trading Union);
- among environmental non-governmental organisations: EEB (European Environmental Bureau).

Eric Aries, George Chronopoulos, María José Cruz Gomez, Frauke Schorcht and Martin Weiss contributed significantly to the internal discussions and task force sessions for the development of this document. Jorge Gomez Benavides and Thibaut Marty contributed significantly to the management of data.

The whole EIPPCB team provided contributions and peer reviewing.

This report was edited by Anna Atkinson and formatted by Daniela Antonova, Carmen Ramirez and Carlos Javier Muñoz Crespo.

This document is one from the series of foreseen documents listed below:

Reference Document on Best Available Techniques (BREF)	Code
Ceramic Manufacturing Industry	CER
Common Waste water and Waste Gas Treatment/Management Systems in the Chemical Sector	CWW
Common Waste Gas Treatment in the Chemical Sector	WGC
Emissions from Storage	EFS
Energy Efficiency	ENE
Ferrous Metals Processing Industry	FMP
Food, Drink and Milk Industries	FDM
Industrial Cooling Systems	ICS
Intensive Rearing of Poultry or Pigs	IRPP
Iron and Steel Production	IS
Large Combustion Plants	LCP
Large Volume Inorganic Chemicals – Ammonia, Acids and Fertilisers Industries	LVIC-AAF
Large Volume Inorganic Chemicals – Solids and Others Industry	LVIC-S
Large Volume Organic Chemical Industry	LVOC
Management of Waste from Extractive Industries	MWEI
Manufacture of Glass	GLS
Manufacture of Organic Fine Chemicals	OFC
Non-ferrous Metals Industries	NFM
Production of Cement, Lime and Magnesium Oxide	CLM
Production of Chlor-alkali	CAK
Production of Polymers	POL
Pulp and Paper Industry	PP
Production of Speciality Inorganic Chemicals	SIC
Production of Wood-based Panels	WBP
Refining of Mineral Oil and Gas	REF
<i>Slaughterhouses, Animal By-products and/or Edible Co-products Industries</i>	SA
Smitheries and Foundries Industry	SF
Surface Treatment of Metals and Plastics	STM
Surface Treatment Using Organic Solvents	STS
Tanning of Hides and Skins	TAN
Textiles Industry	TXT
Waste Incineration	WI
Waste Treatment	WT
Reference Document (REF)	
Economics and Cross-media Effects	ECM
Monitoring of Emissions to Air and Water from IED Installations	ROM

Electronic versions of draft and finalised documents are publicly available and can be downloaded from <http://eippcb.jrc.ec.europa.eu/>.

PREFACE

1. Status of this document

Unless otherwise stated, references to ‘the Directive’ in this document refer to Directive 2010/75/EU of the European Parliament and the Council on industrial emissions (integrated pollution prevention and control) (Recast).

The original best available techniques (BAT) reference document (BREF) on Slaughterhouses and Animal By-products Industries was adopted by the European Commission in 2005. This document is the result of a review of that BREF. The review commenced in 2018.

This BAT reference document for the Slaughterhouses, Animal By-products and /or Edible Co-products Industries forms part of a series presenting the results of an exchange of information between EU Member States, the industries concerned, non-governmental organisations promoting environmental protection and the Commission, to draw up, review, and where necessary, update BAT reference documents as required by Article 13(1) of the Directive. This document is published by the European Commission pursuant to Article 13(6) of the Directive.

As set out in Article 13(5) of the Directive, the Commission Implementing Decision (EU)2023/2749 on the BAT conclusions contained in Chapter 5 was adopted on 11 December 2023 and published on 18 December 2023¹.

2. Participants in the information exchange

As required in Article 13(3) of the Directive, the Commission has established a forum to promote the exchange of information, which is composed of representatives from Member States, the industries concerned and non-governmental organisations promoting environmental protection (Commission Decision of 16 May 2011 establishing a forum for the exchange of information pursuant to Article 13 of the Directive 2010/75/EU on industrial emissions (2011/C 146/03), OJ C 146, 17.05.2011, p. 3).

Forum members have nominated technical experts constituting the technical working group (TWG) that was the main source of information for drafting this document. The work of the TWG was led by the European IPPC Bureau (of the Commission’s Joint Research Centre).

3. Structure and contents of this document

Chapter 1 provides general information on the SA sector in Europe and its key environmental issues (KEIs).

Chapter 2 provides information and data on generally applied processes and techniques, emission levels, techniques to consider in the determination of BAT across the SA sector. As much as possible information on general issues is included in this chapter to avoid repetition.

Chapter 3 provides information and data on applied processes and techniques, emission and consumption levels, techniques to consider in the determination of BAT for slaughterhouses. The chapter includes a general section and sections referring to specific animal species (cattle, pigs, chickens).

Chapter 4 provides information and data on applied processes and techniques, emission and consumption levels, techniques to consider in the determination of BAT for installations

¹ OJ L, 2023/2749, 18.12.2023, ELI: http://data.europa.eu/eli/dec_impl/2023/2749/oj and corrigendum OJ L, 2024/90008, 12.01.2024, ELI: http://data.europa.eu/eli/dec_impl/2023/2749/corrigendum/2024-01-12/oj.

processing animal by-products and/or edible co-products. The chapter includes a general section and sections referring to specific installations, i.e. rendering of animal by-products and/or edible co-products (rendering, fat melting, blood and/or feather processing), fishmeal and fish oil production, gelatine manufacturing.

Chapter 5 presents the BAT conclusions as defined in Article 3(12) of the Directive. These include associated emission levels, and other associated environmental performance levels, as stipulated in the BREF Guidance.

Chapter 6 presents information on ‘emerging techniques’ as defined in Article 3(14) of the Directive.

Concluding remarks and recommendations for future work are presented in Chapter 7.

Annex I (Chapter 8) gives general information about the data collection process, as well as the list of plants that took part in the data collection via questionnaire.

Annex II (Chapter 9) gives examples of various processes flowcharts from installations that participated in the data collection.

4. Information sources and the derivation of BAT

This document is based on information collected from a number of sources, in particular through the TWG that was established specifically for the exchange of information under Article 13 of the Directive. The information has been collated and assessed by the European IPPC Bureau (of the Commission’s Joint Research Centre) who led the work on determining BAT, guided by the principles of technical expertise, transparency and neutrality. The work of the TWG and all other contributors is gratefully acknowledged.

The BAT conclusions have been established through an iterative process involving the following steps:

- identification of the key environmental issues for the Slaughterhouses, Animal By-products and/or Edible Co-products Industries;
- examination of the techniques most relevant to address these key issues;
- identification of the best environmental performance levels, on the basis of the available data in the European Union and worldwide;
- examination of the conditions under which these environmental performance levels were achieved, such as costs, cross-media effects, and the main driving forces involved in the implementation of the techniques;
- selection of the best available techniques (BAT), their associated emission levels (and other environmental performance levels) and the associated monitoring for this sector according to Article 3(10) of, and Annex III to, the Directive.

Expert judgement by the European IPPC Bureau and the TWG has played a key role in each of these steps and the way in which the information is presented here.

Where available, economic data have been given together with the descriptions of the techniques presented in the *Techniques to consider in the determination of BAT* sections. These data give a rough indication of the magnitude of the costs and benefits. However, the actual costs and benefits of applying a technique may depend strongly on the specific situation of the installation concerned, which cannot be evaluated fully in this document. In the absence of data concerning costs, conclusions on the economic viability of techniques are drawn from observations on existing installations.

5. Review of BAT reference documents (BREFs)

BAT is a dynamic concept and so the review of BREFs is a continuing process. For example, new measures and techniques may emerge, science and technologies are continuously developing and new or emerging processes are being successfully introduced into the industries. In order to reflect such changes and their consequences for BAT, this document will be periodically reviewed and, if necessary, updated accordingly.

6. Contact information

All comments and suggestions should be made to the European IPPC Bureau at the Joint Research Centre (JRC) at the following address:

European Commission
JRC Directorate B – Fair and Sustainable Economy
European IPPC Bureau
Edificio Expo
c/ Inca Garcilaso, 3
E-41092 Seville, Spain
Telephone: +34 95 4488 284
E-mail: JRC-B5-EIPPCB@ec.europa.eu
Internet: <http://eippcb.jrc.ec.europa.eu>

Best Available Techniques (BAT) Reference Document for the Slaughterhouses, Animal By-products and/or Edible Co-products Industries

PREFACE	I
SCOPE	XXIII
1 GENERAL INFORMATION ABOUT THE SA SECTOR	1
1.1 KEY ENVIRONMENTAL ISSUES	1
1.1.1 Emissions to water and to air	1
1.1.2 Consumption of energy and water and amount of waste water discharged	3
2 GENERAL PROCESSES AND TECHNIQUES ACROSS THE SA SECTOR	5
2.1 APPLIED PROCESSES AND TECHNIQUES ACROSS THE SA SECTOR	5
2.1.1 Energy efficiency	5
2.1.2 Anaerobic digestion.....	5
2.1.3 Cleaning processes	8
2.1.3.1 Cleaning in slaughterhouses.....	9
2.1.3.2 Cleaning in installations processing animal by-products and/or edible co-products.....	10
2.1.3.3 Use of chemicals	10
2.1.4 Waste water treatment.....	10
2.2 CURRENT CONSUMPTION AND EMISSION LEVELS ACROSS THE SA SECTOR.....	13
2.2.1 Emissions to water	13
2.2.1.1 Chemical oxygen demand (COD).....	13
2.2.1.2 Total organic carbon (TOC).....	18
2.2.1.3 Biochemical oxygen demand in 5 days (BOD ₅).....	20
2.2.1.4 Total suspended solids (TSS).....	23
2.2.1.5 Total nitrogen (Total N).....	26
2.2.1.6 Total phosphorus (Total P).....	29
2.2.1.7 Adsorbable organically bound halogens (AOX)	33
2.2.1.8 Chloride.....	36
2.2.2 Emissions to air	37
2.2.2.1 Emissions to air from combustion in boilers of malodorous gases, including non-condensable gases	37
2.2.2.1.1 Dust	37
2.2.2.1.2 NO _x	39
2.2.2.1.3 SO _x	41
2.2.2.1.4 CO	44
2.2.2.2 Emissions to air from thermal oxidation	46
2.2.2.2.1 Dust	46
2.2.2.2.2 NO _x	47
2.2.2.2.3 SO _x	49
2.2.2.2.4 CO	51
2.2.2.3 Emissions to air from combustion of animal fat and meat-and-bone meal (MBM).....	52
2.2.2.3.1 Dust	52
2.2.2.3.2 NO _x	52
2.2.2.3.3 SO _x	53
2.2.2.3.4 CO	53

2.3	TECHNIQUES TO CONSIDER IN THE DETERMINATION OF BAT ACROSS THE SA SECTOR	55
2.3.1	General environmental performance.....	55
2.3.1.1	Environmental management systems.....	55
2.3.1.2	Use of a planned maintenance programme	58
2.3.1.3	Chemicals management system	59
2.3.1.4	Set-up and implementation of an OTNOC management plan to reduce emissions during OTNOC	60
2.3.2	Techniques to increase resource efficiency	62
2.3.2.1	Anaerobic digestion	62
2.3.2.2	Residues separation and recycling/recovery	64
2.3.2.3	Overfilling protection on bulk storage tanks, e.g. containing blood	65
2.3.2.4	Bunding of bulk storage tanks, e.g. containing blood.....	66
2.3.2.5	Double skin protection of bulk storage tanks, e.g. containing blood	67
2.3.2.6	Minimisation of biological degradation of animal by-products and/or edible co- products	68
2.3.2.7	Phosphorus recovery as struvite	71
2.3.2.8	Integrated site - slaughterhouse and rendering plant	73
2.3.3	Monitoring	74
2.3.3.1	Overview	74
2.3.3.2	Integrated monitoring system	74
2.3.3.3	Monitoring of influent and effluent waste water	75
2.3.3.4	Monitoring of emissions to water	76
2.3.3.5	Monitoring of channelled emissions to air.....	77
2.3.3.6	Odour monitoring	78
2.3.3.7	Inventory of inputs and outputs	79
2.3.4	Techniques to increase energy efficiency	80
2.3.4.1	General processing techniques.....	80
2.3.4.1.1	Energy efficiency plan and audits.....	80
2.3.4.1.2	Monitoring of energy consumption.....	82
2.3.4.1.3	Lighting management systems and energy-efficient lighting	83
2.3.4.1.4	Heat recovery.....	84
2.3.4.1.5	Energy-efficient motors	85
2.3.4.1.6	Frequency converters on motors.....	86
2.3.4.1.7	Process control systems	87
2.3.4.1.8	Combined heat and power generation (cogeneration).....	88
2.3.4.1.9	Insulation of pipes, vessels and other equipment.....	89
2.3.4.1.10	Combustion regulation and control.....	90
2.3.4.1.11	Pre-cleaning of blood and meat juice contamination with cold water	91
2.3.4.1.12	Optimisation of design and operation of cooling system(s).....	91
2.3.4.2	Techniques related to steam systems	93
2.3.4.2.1	Feed water preheating (including the use of economisers).....	93
2.3.4.2.2	Minimisation of the blowdown of boilers.....	94
2.3.4.2.3	Optimisation of steam distribution systems	95
2.3.4.2.4	Use of thermostatically controlled steam- and water-blending valves.....	96
2.3.4.3	Techniques related to compressed air	97
2.3.4.3.1	Reduction of compressed air system leaks.....	97
2.3.5	Techniques to reduce water consumption.....	98
2.3.5.1	Management, design and operation techniques	98
2.3.5.1.1	Water management plan and water audits	98
2.3.5.1.2	Water reuse and/or recycling	98
2.3.5.1.3	Optimisation of water flow	99
2.3.5.1.4	Optimisation and appropriate use of water nozzles and hoses.....	100
2.3.5.1.5	Segregation of water streams	103
2.3.5.1.6	Dry transport of by-products.....	104
2.3.5.2	Techniques related to cleaning	104
2.3.5.2.1	Dry cleaning.....	104

2.3.5.2.2	High-pressure cleaning.....	106
2.3.5.2.3	Optimisation of chemical dosing and water use in cleaning-in-place (CIP).....	107
2.3.5.2.4	Low-pressure foam and/or gel cleaning	108
2.3.5.2.5	Optimised design and construction of equipment and process areas.....	109
2.3.5.2.6	Fitting of cleaning hoses with hand-operated triggers.....	111
2.3.5.2.7	Prompt cleaning of equipment.....	111
2.3.6	Waste water treatment techniques.....	112
2.3.6.1	Preliminary, primary and general treatment.....	112
2.3.6.1.1	Screening of solids	112
2.3.6.1.2	Fat, oil and grease removal.....	114
2.3.6.1.3	Equalisation.....	115
2.3.6.1.4	Buffer storage for waste water	116
2.3.6.2	Physico-chemical treatment	117
2.3.6.2.1	Chemical oxidation (e.g. with ozone).....	117
2.3.6.2.2	Precipitation	118
2.3.6.3	Secondary treatment.....	118
2.3.6.3.1	Aerobic treatment.....	118
2.3.6.3.2	Anaerobic treatment	125
2.3.6.3.3	Aerobic/anaerobic treatment	126
2.3.6.4	Nitrogen removal	128
2.3.6.4.1	Nitrification and/or denitrification	128
2.3.6.4.2	Partial nitrification-anaerobic ammonium oxidation.....	129
2.3.6.5	Phosphorus removal	130
2.3.6.5.1	Precipitation	130
2.3.6.5.2	Enhanced biological phosphorus removal.....	131
2.3.6.5.3	Phosphorus recovery as struvite	132
2.3.6.6	Final solids removal	132
2.3.6.6.1	Coagulation and flocculation.....	132
2.3.6.6.2	Flotation	133
2.3.6.7	Other general techniques applicable in slaughterhouses and animal by-products installations	136
2.3.6.7.1	Electrocoagulation.....	136
2.3.7	Techniques to avoid the use of harmful substances	139
2.3.7.1	Proper selection of cleaning chemicals and/or disinfectants.....	139
2.3.7.2	Management of water and detergent consumption.....	140
2.3.7.3	Reuse of cleaning chemicals in cleaning-in-place.....	141
2.3.7.4	Dry cleaning.....	141
2.3.7.5	Optimised design and construction of equipment and process areas.....	141
2.3.8	Techniques to reduce emissions to air.....	142
2.3.8.1	Techniques applicable to a number of pollutants	142
2.3.8.1.1	Fuel choice	142
2.3.8.1.2	Optimisation of thermal oxidation or combustion in boilers	142
2.3.8.1.3	Removal of high levels of dust, NO _x and SO _x precursors	143
2.3.8.2	Techniques mainly used to reduce organic and odour emissions.....	143
2.3.8.2.1	Odour management plan	143
2.3.8.2.2	Minimisation of biological degradation of animal by-products and/or edible co-products	144
2.3.8.2.3	Regular cleaning of installations and equipment.....	144
2.3.8.2.4	Cleaning and disinfection of vehicles and equipment used to transport and deliver animal by-products and/or edible co-products	145
2.3.8.2.5	Dilution of odours by capture into one or more chimneys	146
2.3.8.2.6	Enclosure of animal by-products and/or edible co-products during transport, reception, loading/unloading and storage.....	147
2.3.8.2.7	Refrigeration/cooling of blood	149
2.3.8.2.8	Biofilter	151
2.3.8.2.9	Adsorption.....	157
2.3.8.2.10	Condensation.....	158

2.3.8.2.11	Wet scrubber.....	160
2.3.8.2.12	Bioscrubber.....	162
2.3.8.2.13	Thermal oxidation.....	163
2.3.8.2.14	Combustion in a steam boiler of malodorous gases, including non-condensable gases.....	168
2.3.8.3	Techniques to reduce dust emissions.....	169
2.3.8.3.1	Bag filter.....	169
2.3.8.3.2	Cyclone.....	170
2.3.8.4	Techniques to reduce NO _x emissions.....	170
2.3.8.4.1	Low-NO _x burners.....	170
2.3.9	Techniques to reduce noise emissions.....	171
2.3.9.1	Noise management plan.....	171
2.3.9.2	Noise reduction at source and noise abatement.....	173
2.3.10	Techniques to minimise the environmental impact of the use of refrigerants.....	174
2.3.10.1	Use of refrigerants without ozone depletion potential and with low global warming potential.....	174
3	SLAUGHTERHOUSES.....	177
3.1	GENERAL INFORMATION FOR SLAUGHTERHOUSES.....	177
3.1.1	Production of meat and livestock population in the European Union.....	177
3.1.2	Trends of the slaughtering industry in the European Union.....	178
3.1.3	Level of process automation.....	178
3.1.4	Antimicrobial resistance.....	179
3.1.4.1	Methods for identifying AMR.....	181
3.2	GENERAL PROCESSES AND TECHNIQUES FOR SLAUGHTERHOUSES.....	182
3.2.1	Applied processes and techniques for slaughterhouses.....	182
3.2.1.1	Chilling.....	182
3.2.1.2	Casings and offal treatment.....	182
3.2.1.3	Composting.....	183
3.2.1.4	Storage of slaughterhouse by-products.....	186
3.2.2	Current consumption and emission levels across slaughterhouses.....	186
3.2.2.1	Consumption of chemicals in slaughterhouse cleaning.....	186
3.2.2.2	Emissions to water.....	188
3.2.2.3	Emissions to air.....	193
3.2.2.4	Refrigerant losses.....	195
3.2.2.5	Noise and vibration.....	196
3.2.3	Techniques to consider in the determination of BAT across slaughterhouses.....	197
3.2.3.1	Techniques to increase energy efficiency.....	197
3.2.3.1.1	Techniques related to cooling/freezing.....	197
3.2.3.2	Techniques to reduce water consumption.....	201
3.2.3.2.1	General techniques.....	201
3.2.3.2.2	Techniques relating to casings and offal treatment.....	208
3.2.3.3	Techniques to reduce emissions to water.....	209
3.2.3.3.1	Optimisation of bleeding and blood collection.....	209
3.2.3.3.2	Use of a squeegee for initial cleaning of the blood collection trough.....	211
3.2.3.3.3	Double drain from the bleed hall.....	212
3.2.3.3.4	Cessation of feeding of animals 12 hours prior to slaughter.....	213
3.2.3.3.5	Minimisation of animals' time in the slaughterhouse to reduce manure production.....	213
3.2.3.4	Techniques to reduce emissions to air.....	214
3.2.3.4.1	Techniques mainly used to reduce organic/odour emissions.....	214
3.2.3.5	Techniques to minimise the environmental impact of the use of refrigerants.....	216
3.2.3.5.1	Refrigeration management plan.....	216
3.2.3.5.2	Preventive and corrective maintenance.....	216
3.2.3.5.3	Use of refrigerant leak detectors.....	217
3.3	SLAUGHTER OF LARGE ANIMALS.....	218

3.3.1	Applied processes and techniques.....	218
3.3.1.1	General applied processes and techniques for all large animals.....	218
3.3.1.1.1	Animal reception and lairage	218
3.3.1.1.2	Slaughter	219
3.3.1.1.3	Bleeding	221
3.3.1.1.4	Hide and skin treatment.....	223
3.3.1.1.5	Evisceration.....	224
3.3.1.1.6	Splitting.....	225
3.3.1.2	Additional applied processes and techniques for cattle slaughterhouses	225
3.3.1.2.1	Head and hoof removal for cattle	226
3.3.1.3	Additional applied processes and techniques for pig slaughterhouses	226
3.3.1.3.1	Pig scalding	227
3.3.1.3.2	Pig hair and toenail removal.....	228
3.3.1.3.3	Pig singeing.....	229
3.3.1.3.4	Rind treatment.....	229
3.3.1.3.5	Chilling of pig carcasses.....	229
3.3.1.4	Additional applied processes and techniques for sheep slaughterhouses	232
3.3.1.4.1	Head and hoof removal for sheep.....	232
3.3.2	Current consumption and emission levels.....	232
3.3.2.1	General issues	232
3.3.2.1.1	Energy consumption.....	232
3.3.2.1.2	Water consumption	232
3.3.2.1.3	Noise	232
3.3.2.1.4	Emissions to water	233
3.3.2.2	Cattle slaughterhouses.....	235
3.3.2.2.1	Energy consumption.....	235
3.3.2.2.2	Water consumption	241
3.3.2.2.3	Emissions to water	244
3.3.2.3	Pig slaughterhouses.....	247
3.3.2.3.1	Energy consumption.....	247
3.3.2.3.2	Water consumption	254
3.3.2.3.3	Emissions to water	258
3.3.2.3.4	Emissions to air	261
3.3.3	Techniques to consider in the determination of BAT for the slaughter of large animals	262
3.3.3.1	Techniques to reduce waste.....	262
3.3.3.1.1	Trimming of all hide/skin material not destined for tanning immediately after removal from the animal	262
3.3.3.2	Techniques to reduce emissions to water	263
3.3.3.2.1	Storage of hides and skins at 10-15 °C	263
3.3.3.2.2	Drum salting of hides and skins	264
3.3.3.2.3	Drum salting of skins with added boric acid	265
3.3.3.2.4	Dry collection of salt residues from hide, skin or fur preservation	266
3.3.3.2.5	Preservation of hides and skins by refrigeration	267
3.3.4	Techniques to consider in the determination of BAT for pig slaughterhouses	268
3.3.4.1	Techniques to increase energy efficiency.....	268
3.3.4.1.1	Steam scalding of pigs.....	268
3.3.4.1.2	Heat recovery from pig singeing exhaust gases, to preheat water.....	270
3.3.4.1.3	Immersion scalding with optimised water flow systems	272
3.3.4.2	Techniques to reduce water consumption	272
3.3.4.2.1	Steam scalding of pigs.....	272
3.3.4.2.2	Recirculation of water within pig de-hairing machines.....	272
3.3.4.2.3	Reuse of cooling water from the singeing kiln.....	273
3.3.4.2.4	Water level control on pig scalding tanks	275
3.3.4.2.5	‘Dry’ collection of the contents of pigs’ small intestines	275
3.3.4.2.6	Immersion scalding with optimised water flow systems	276
3.3.4.3	Techniques to reduce emissions to air.....	276

3.3.4.3.1	Reduction of the pig singeing time	276
3.4	SLAUGHTER OF POULTRY	278
3.4.1	Applied processes and techniques	278
3.4.1.1	Reception of birds.....	278
3.4.1.2	Stunning and bleeding	279
3.4.1.3	Scalding	280
3.4.1.4	Defeathering	280
3.4.1.5	Evisceration	280
3.4.1.6	Chilling.....	281
3.4.1.7	Maturation	282
3.4.2	Current consumption and emission levels	282
3.4.2.1	Chicken slaughterhouses	282
3.4.2.1.1	Energy consumption	282
3.4.2.1.2	Water consumption.....	287
3.4.2.2	Emissions to water.....	291
3.4.3	Techniques to consider in the determination of BAT	294
3.4.3.1	General environmental performance.....	294
3.4.3.1.1	Low-atmospheric-pressure stunning	294
3.4.3.1.2	Controlled atmosphere stunning	296
3.4.3.1.3	Electrical water bath stunning (head only).....	297
3.4.3.2	Techniques to increase energy efficiency	298
3.4.3.2.1	Immersion scalding with optimised water flow systems	298
3.4.3.3	Techniques to reduce water consumption.....	299
3.4.3.3.1	Reuse of crate washing water	299
3.4.3.3.2	Use of recycled water, e.g. from scalding, for the transfer of feathers	300
3.4.3.3.1	Immersion scalding with optimised water flow systems	300
4	INSTALLATIONS PROCESSING ANIMAL BY-PRODUCTS AND/OR EDIBLE CO-PRODUCTS	301
4.1	GENERAL INFORMATION FOR INSTALLATIONS PROCESSING ANIMAL BY-PRODUCTS AND/OR EDIBLE CO-PRODUCTS	301
4.2	GENERAL PROCESSES AND TECHNIQUES ACROSS INSTALLATIONS PROCESSING ANIMAL BY-PRODUCTS AND/OR EDIBLE CO-PRODUCTS	303
4.2.1	Applied processes and techniques across installations processing animal by-products and/or edible co-products.....	303
4.2.1.1	Odour treatment in installations processing animal by-products and/or edible co-products	303
4.2.1.1.1	Approach to assessing odour characteristics – sensorial analysis procedure	305
4.2.1.2	Combustion of meat-and-bone meal / animal fat.....	309
4.2.1.3	Incineration of carcasses.....	312
4.2.1.4	Evaporation.....	314
4.2.1.5	Emissions to water.....	315
4.2.2	Current consumption and emission levels across installations processing animal by-products and/or edible co-products.....	315
4.2.2.1	Combustion of animal fat	315
4.2.3	Techniques to consider in the determination of BAT across installations processing animal by-products and/or edible co-products.....	316
4.2.3.1	Techniques to increase energy efficiency	316
4.2.3.1.1	Multiple-effect evaporators.....	316
4.2.3.2	Techniques to reduce emissions to water.....	318
4.2.3.2.1	Use of fresh refrigerated raw materials.....	318
4.2.3.3	Techniques to reduce emissions to air	320
4.2.3.3.1	Enclosure of animal by-products and/or edible co-products during transport, reception, loading/unloading and storage	320
4.2.3.3.2	Maintenance of negative pressure in storage, handling and processing areas	320

4.2.3.3.3	Use of fresh refrigerated raw materials	321
4.3	RENDERING OF ANIMAL BY-PRODUCTS AND/OR EDIBLE CO-PRODUCTS (RENDERING, FAT MELTING, BLOOD AND/OR FEATHER PROCESSING)	322
4.3.1	General information	322
4.3.2	Applied processes and techniques.....	325
4.3.2.1	General.....	325
4.3.2.2	Raw material reception, handling and tipping.....	329
4.3.2.3	Raw material processing	332
4.3.2.4	Fat melting	335
4.3.2.4.1	Melting with direct steam.....	336
4.3.2.4.2	Melting with indirect steam.....	337
4.3.2.5	Blood processing.....	338
4.3.2.5.1	Blood processing – blood meal	338
4.3.2.5.2	Blood processing - plasma and haemoglobin.....	340
4.3.2.6	Feather processing.....	342
4.3.2.7	Production of pulp.....	343
4.3.2.8	Odour abatement systems.....	344
4.3.2.8.1	General concepts	344
4.3.2.8.2	Condensers	345
4.3.2.8.3	Thermal oxidation	345
4.3.2.8.4	Biofilters.....	346
4.3.2.8.5	Chemical scrubbers	346
4.3.2.9	Sludge management options.....	347
4.3.3	Current emission and consumption levels.....	347
4.3.3.1	Energy consumption.....	347
4.3.3.2	Water consumption	351
4.3.3.3	Emissions to water	354
4.3.3.4	Emissions to air	356
4.3.3.5	Noise and vibration	364
4.3.4	Techniques to consider in the determination of BAT	364
4.3.4.1	Techniques to reduce emissions to water	364
4.3.4.1.1	Use of H ₂ O ₂ to remove H ₂ S from waste water in feather rendering plants ..	364
4.3.4.2	Techniques to reduce emissions to air.....	365
4.3.4.2.1	Ammonia stripping of exhaust vapour condensates from rendering	365
4.3.4.2.2	Ammoniacal-N removal from rendering condensate by ammonia conversion	366
4.4	FISHMEAL AND FISH OIL PRODUCTION	367
4.4.1	General information about the sector	367
4.4.2	Applied processes and techniques.....	367
4.4.3	Current emission and consumption levels.....	369
4.4.3.1	Energy consumption.....	369
4.4.3.2	Water consumption	372
4.4.3.3	Emissions to water	373
4.4.3.4	Emissions to air	374
4.4.3.5	Noise	379
4.4.4	Techniques to consider in the determination of BAT	379
4.4.4.1	Techniques to increase energy efficiency.....	379
4.4.4.1.1	Use of heat from vapour from drying fishmeal in a falling film evaporator, to concentrate stickwater	379
4.4.4.2	Techniques to reduce emissions to air.....	382
4.4.4.2.1	Use of fresh low-total-volatile-nitrogen (TVN) feedstock	382
4.4.4.2.2	Incineration of malodorous air, with heat recovery.....	384
4.5	GELATINE MANUFACTURING	385
4.5.1	General information about the sector	385
4.5.2	Applied processes and techniques.....	385

4.5.2.1	Description of the main gelatine manufacturing processes.....	386
4.5.2.2	Dicalcium phosphate manufacture from the gelatine manufacture demineralisation liquor	396
4.5.3	Current emission and consumption levels	397
4.5.3.1	Energy consumption	397
4.5.3.2	Water consumption.....	400
4.5.3.3	Emissions to water.....	400
4.5.3.4	Emissions to air	401
4.5.4	Techniques to consider in the determination of BAT	402
4.5.4.1	Techniques to increase resource efficiency	402
4.5.4.1.1	Landspreading of sludge from gelatine and leather glue manufacture.....	402
5	BEST AVAILABLE TECHNIQUES (BAT) CONCLUSIONS FOR SLAUGHTERHOUSES, ANIMAL BY-PRODUCTS AND/OR EDIBLE CO-PRODUCTS INDUSTRIES.....	403
	SCOPE.....	403
	DEFINITIONS.....	405
	ACRONYMS.....	407
	GENERAL CONSIDERATIONS	408
5.1	GENERAL BAT CONCLUSIONS	411
5.1.1	Overall environmental performance	411
5.1.2	Monitoring.....	414
5.1.3	Energy efficiency.....	417
5.1.4	Water consumption and waste water generation	418
5.1.5	Harmful substances.....	419
5.1.6	Resource efficiency.....	419
5.1.7	Emissions to water.....	420
5.1.8	Emissions to air.....	423
5.1.9	Noise.....	424
5.1.10	Odour	425
5.1.11	Use of refrigerants	426
5.2	BAT CONCLUSIONS FOR SLAUGHTERHOUSES	427
5.2.1	Energy efficiency.....	427
5.2.2	Water consumption and waste water generation	428
5.2.3	Use of refrigerants	428
5.3	BAT CONCLUSIONS FOR INSTALLATIONS PROCESSING ANIMAL BY-PRODUCTS AND/OR EDIBLE CO-PRODUCTS.....	430
5.3.1	Energy efficiency.....	430
5.3.2	Water consumption and waste water generation	430
5.3.3	Emissions to air.....	431
5.4	DESCRIPTION OF TECHNIQUES.....	433
5.4.1	Emissions to water.....	433
5.4.2	Emissions to air.....	434
5.4.3	Use of refrigerants	435
6	EMERGING TECHNIQUES	437
6.1	GENERAL.....	437
6.1.1	Microalgal heterotrophic bioreactors.....	437
6.1.2	Microbial fuel cells.....	438
6.1.3	UV photooxidation	440
6.2	EMERGING TECHNIQUES FOR SLAUGHTERHOUSES.....	443

6.2.1	Superchilling	443
6.2.2	Recycling of water in chickens' feet line	444
6.3	EMERGING TECHNIQUES FOR INSTALLATIONS PROCESSING ANIMAL BY-PRODUCTS AND/OR EDIBLE CO-PRODUCTS	446
6.3.1	Hydrothermal liquefaction	446
7	CONCLUDING REMARKS AND RECOMMENDATIONS FOR FUTURE WORK.....	449
8	ANNEX I: SA DATA COLLECTION	453
8.1	THE DATA COLLECTION PROCESS	453
8.2	DISTRIBUTION OF SA INSTALLATIONS	453
8.3	LIST OF INSTALLATIONS THAT PARTICIPATED IN THE SA DATA COLLECTION	456
9	ANNEX II: EXAMPLES OF FLOWCHARTS	485
9.1	SLAUGHTERHOUSES.....	485
9.2	PROCESSING OF ANIMAL-BY PRODUCTS AND/OR EDIBLE CO-PRODUCTS	488
10	GLOSSARY.....	491
11	REFERENCES.....	501

List of figures

Figure 2.1:	COD emissions to water (mg/l) from slaughterhouses (direct discharges) (Part 1 of 2).....	14
Figure 2.2:	COD emissions to water (mg/l) from slaughterhouses (direct discharges) (Part 2 of 2).....	15
Figure 2.3:	COD emissions to water (mg/l) from installations processing animal by-products and/or edible co-products (direct discharges) (Part 1 of 2)	16
Figure 2.4:	COD emissions to water (mg/l) from installations processing animal by-products and/or edible co-products (direct discharges) (Part 2 of 2)	17
Figure 2.5:	TOC emissions to water (mg/l) from SA installations (direct discharges).....	19
Figure 2.6:	BOD ₅ emissions to water (mg/l) from SA installations (direct discharges) (Part 1 of 2).....	21
Figure 2.7:	BOD ₅ emissions to water (mg/l) from SA installations (direct discharges) (Part 2 of 2).....	22
Figure 2.8:	TSS emissions to water (mg/l) from SA installations (direct discharges) (Part 1 of 2).....	24
Figure 2.9:	TSS emissions to water (mg/l) from SA installations (direct discharges) (Part 2 of 2).....	25
Figure 2.10:	Total N emissions to water (mg/l) from SA installations (direct discharges) (Part 1 of 2) ..	28
Figure 2.11:	Total N emissions to water (mg/l) from SA installations (direct discharges) (Part 2 of 2) ..	28
Figure 2.12:	Total P emissions to water (mg/l) from SA installations (direct discharges) (Part 1 of 3)...	30
Figure 2.13:	Total P emissions to water (mg/l) from SA installations (direct discharges) (Part 2 of 3)...	31
Figure 2.14:	Total P emissions to water (mg/l) from SA installations (direct discharges) (Part 3 of 3)...	32
Figure 2.15:	AOX emissions to water (mg/l) from SA installations (direct discharges)	34
Figure 2.16:	AOX emissions to water (mg/l) from SA installations (indirect discharges)	35
Figure 2.17:	Dust emissions to air (mg/Nm ³) from combustion in boilers of malodorous gases, including non-condensable gases, in SA installations	37
Figure 2.18:	Dust emissions to air (mg/Nm ³) from combustion in boilers of malodorous gases, including non-condensable gases, in SA installations (values corrected to 3 % O ₂).....	38
Figure 2.19:	NO _x emissions to air (mg/Nm ³) from combustion in boilers of malodorous gases, including non-condensable gases, in SA installations	39
Figure 2.20:	NO _x emissions to air (mg/Nm ³) from combustion in boilers of malodorous gases, including non-condensable gases, in SA installations (values corrected to 3 % O ₂).....	40
Figure 2.21:	SO _x emissions to air (mg/Nm ³) from combustion in boilers of malodorous gases, including non-condensable gases, in SA installations (Part 1 of 2)	41
Figure 2.22:	SO _x emissions to air (mg/Nm ³) from combustion in boilers of malodorous gases, including non-condensable gases, in SA installations (Part 2 of 2)	42
Figure 2.23:	SO _x emissions to air (mg/Nm ³) from combustion in boilers of malodorous gases, including non-condensable gases, in SA installations (values corrected to 3 % O ₂).....	43
Figure 2.24:	CO emissions to air (mg/Nm ³) from combustion in boilers of malodorous gases, including non-condensable gases, in SA installations	44
Figure 2.25:	CO emissions to air (mg/Nm ³) from combustion in boilers of malodorous gases, including non-condensable gases, in SA installations (values corrected to 3 % O ₂).....	45
Figure 2.26:	Dust emissions to air (mg/Nm ³) from thermal oxidation in SA installations	46
Figure 2.27:	NO _x emissions to air (mg/Nm ³) from thermal oxidation in SA installations (Part 1 of 2)...	47
Figure 2.28:	NO _x emissions to air (mg/Nm ³) from thermal oxidation in SA installations (Part 2 of 2)...	48
Figure 2.29:	SO _x emissions to air (mg/Nm ³) from thermal oxidation in SA installations (Part 1 of 2) ...	49
Figure 2.30:	SO _x emissions to air (mg/Nm ³) from thermal oxidation in SA installations (Part 2 of 2) ...	50
Figure 2.31:	CO emissions to air (mg/Nm ³) from thermal oxidation in SA installations	51
Figure 2.32:	Dust emissions to air (mg/ Nm ³) from combustion of animal fat in SA installations	52
Figure 2.33:	NO _x emissions to air (mg/Nm ³) from combustion of animal fat in SA installations	52
Figure 2.34:	SO _x emissions to air (mg/Nm ³) from combustion of animal fat in SA installations	53
Figure 2.35:	CO emissions to air (mg/Nm ³) from combustion of animal fat in SA installations	53
Figure 2.36:	Continuous improvement in an EMS model	56
Figure 2.37:	Flow diagram for one example of phosphorus recovery as struvite	71
Figure 2.38:	Diagram of a moving bed trickling filter designed to treat waste water and emissions to air	124
Figure 2.39:	Membrane tanks belonging to a MBR process.....	127
Figure 2.40:	Principal components of dissolved air flotation	135
Figure 2.41:	Overview of an electrocoagulation plant.....	137
Figure 2.42:	Scheme of an open surface biofilter	152
Figure 2.43:	Scheme of a condensation unit.....	159
Figure 2.44:	Consumption, emission and economic data for a thermal oxidiser for the combustion of vapour, non-condensable gases and room air in rendering.....	167
Figure 3.1:	Production of meat in 2019 in the EU-27.....	177
Figure 3.2:	Livestock population in 2019 in the EU-27	178

Figure 3.3:	Flowchart showing the windrow composting process	184
Figure 3.4:	Diagram illustrating the in-vessel composting process.....	185
Figure 3.5:	Cu emissions to water (mg/l) from slaughterhouses (direct discharges).....	189
Figure 3.6:	Cu emissions to water (mg/l) from slaughterhouses (indirect discharges)	190
Figure 3.7:	Zn emissions to water (mg/l) from slaughterhouses (direct discharges).....	191
Figure 3.8:	Zn emissions to water (mg/l) from slaughterhouses (indirect discharges).....	192
Figure 3.9:	Odour emissions (ou_E/m^3) and abatement techniques from slaughterhouses (Part 1 of 2)	194
Figure 3.10:	Odour emissions (ou_E/m^3) and abatement techniques from slaughterhouses (Part 2 of 2)	195
Figure 3.11:	R717 (NH_3) losses (%)	196
Figure 3.12:	R404A losses (%)	196
Figure 3.13:	A typical flow scheme of cattle slaughtering.....	226
Figure 3.14:	A typical flow scheme of pig slaughtering	227
Figure 3.15:	Generic pig slaughterhouse layout.....	228
Figure 3.16:	Specific net energy consumption (kWh/tonne of carcass) and applied techniques to reduce energy consumption in cattle slaughterhouses (installation level)	236
Figure 3.17:	Specific electricity and heat consumption (kWh/tonne of carcass) in cattle slaughterhouses (installation level).....	237
Figure 3.18:	Specific net energy consumption (kWh/tonne of carcass) in cattle slaughterhouses for cooling systems.....	237
Figure 3.19:	Specific net energy consumption (kWh/tonne of carcass) in cattle slaughterhouses for production of hot water for cleaning and disinfection	238
Figure 3.20:	Specific net energy consumption (kWh/animal) and applied techniques to reduce energy consumption in cattle slaughterhouses (installation level).....	239
Figure 3.21:	Specific net electricity and heat consumption (kWh/animal) in cattle slaughterhouses (installation level)	240
Figure 3.22:	Specific net energy consumption (kWh/animal) in cattle slaughterhouses for cooling systems	240
Figure 3.23:	Specific net energy consumption (kWh/animal) for production of hot water for cleaning and disinfection in cattle slaughterhouses.....	241
Figure 3.24:	Specific net water consumption (m^3 /tonne of carcass) in cattle slaughterhouses (installation level)	241
Figure 3.25:	Specific net water consumption (m^3 /tonne of carcass) for cleaning of floors/walls and equipment in cattle slaughterhouses	242
Figure 3.26:	Specific net water consumption (m^3 /tonne of carcass) for handling of casings and offal in cattle slaughterhouses	242
Figure 3.27:	Specific net water consumption (m^3 /tonne of carcass) for vehicle washing in cattle slaughterhouses.....	242
Figure 3.28:	Specific net water consumption (m^3 /animal) in cattle slaughterhouses (installation level)	243
Figure 3.29:	Specific net water consumption (m^3 /animal) for cleaning of floors/walls and equipment in cattle slaughterhouses	243
Figure 3.30:	Specific net water consumption (m^3 /animal) for handling of casings and offal in cattle slaughterhouses.....	244
Figure 3.31:	Specific net water consumption (m^3 /animal) for vehicle washing in cattle slaughterhouses.....	244
Figure 3.32:	Specific waste water discharge (m^3 /tonne of carcass) in cattle slaughterhouses for all types of discharges and applied techniques to reduce water consumption	245
Figure 3.33:	Specific waste water discharge (m^3 /animal) in cattle slaughterhouses for all types of discharges and reported techniques to reduce water consumption	246
Figure 3.34:	Specific net energy consumption (kWh/tonne of carcass) and applied techniques to reduce energy consumption in pig slaughterhouses (installation level).....	248
Figure 3.35:	Specific net electricity and heat consumption (kWh/tonne of carcass) in pig slaughterhouses (installation level).....	249
Figure 3.36:	Specific net energy consumption (kWh/tonne of carcass) for cooling systems in pig slaughterhouses.....	249
Figure 3.37:	Specific net energy consumption (kWh/tonne of carcass) for production of hot water for cleaning and disinfection in pig slaughterhouses.....	250
Figure 3.38:	Specific net energy consumption (kWh/tonne of carcass) for pig singeing in pig slaughterhouses.....	250
Figure 3.39:	Specific net energy consumption (kWh/tonne of carcass) for scalding in pig slaughterhouses.....	250
Figure 3.40:	Specific net energy consumption (kWh/animal) and applied techniques to reduce energy consumption in pig slaughterhouses (installation level)	251

Figure 3.41: Specific net electricity and heat consumption (kWh/animal) in pig slaughterhouses (installation level).....	252
Figure 3.42: Specific net energy consumption (kWh/animal) for cooling systems in pig slaughterhouses	252
Figure 3.43: Specific net energy consumption (kWh/animal) for production of hot water for cleaning and disinfection in pig slaughterhouses.....	253
Figure 3.44: Specific net energy consumption (kWh/animal) for pig singeing in pig slaughterhouses..	253
Figure 3.45: Specific net energy consumption (kWh/animal) for scalding in pig slaughterhouses	254
Figure 3.46: Specific net water consumption (m ³ /tonne of carcass) in pig slaughterhouses (installation level).....	255
Figure 3.47: Specific net water consumption (m ³ /tonne of carcass) for cleaning of floors/walls and equipment in pig slaughterhouses	255
Figure 3.48: Specific net water consumption (m ³ /tonne of carcass) for handling of casings and offal in pig slaughterhouses	255
Figure 3.49: Specific net water consumption (m ³ /tonne of carcass) for scalding in pig slaughterhouses	256
Figure 3.50: Specific net water consumption (m ³ /tonne of carcass) for vehicle washing in pig slaughterhouses	256
Figure 3.51: Specific net water consumption (m ³ /animal) in pig slaughterhouses (installation level) ...	256
Figure 3.52: Specific net water consumption (m ³ /animal) for cleaning of floors/walls and equipment in pig slaughterhouses	257
Figure 3.53: Specific net water consumption (m ³ /animal) for handling of casings and offal in pig slaughterhouses	257
Figure 3.54: Specific net water consumption (m ³ /animal) for scalding in pig slaughterhouses	257
Figure 3.55: Specific net water consumption (m ³ /animal) for vehicle washing in pig slaughterhouses.	258
Figure 3.56: Specific waste water discharge per emission point (m ³ /tonne of carcass) in pig slaughterhouses for all types of discharges and reported techniques to reduce water consumption	259
Figure 3.57: Specific waste water discharge per emission point (m ³ /animal) in pig slaughterhouses for all types of discharges and reported techniques to reduce water consumption.....	260
Figure 3.58: Outline of a condensation scalding tunnel.....	268
Figure 3.59: Heat recovery from pig singeing gases	271
Figure 3.60: Recirculation of water for de-hairing pigs.....	273
Figure 3.61: The Grinsted system reusing cooling water from a singeing kiln	274
Figure 3.62: A typical flow scheme of poultry slaughtering	278
Figure 3.63: Specific net energy consumption (kWh/tonne of carcass) and applied techniques to reduce energy consumption in chicken slaughterhouses (installation level)	283
Figure 3.64: Specific electricity and heat consumption (kWh/tonne of carcass) in chicken slaughterhouses (installation level)	284
Figure 3.65: Specific net energy consumption (kWh/tonne of carcass) for cooling systems in chicken slaughterhouses	284
Figure 3.66: Specific net energy consumption (kWh/animal) and applied techniques to reduce energy consumption in chicken slaughterhouses (installation level)	285
Figure 3.67: Specific net electricity and heat consumption (kWh/animal) in chicken slaughterhouses (installation level).....	286
Figure 3.68: Specific net energy consumption (kWh/animal) for cooling systems in chicken slaughterhouses	286
Figure 3.69: Specific net water consumption (m ³ /tonne of carcass) for chicken slaughterhouses (installation level).....	287
Figure 3.70: Specific net water consumption (m ³ /tonne of carcass) for cleaning of floors/walls and equipment in chicken slaughterhouses	288
Figure 3.71: Specific net water consumption (m ³ /tonne of carcass) for defeathering in chicken slaughterhouses	288
Figure 3.72: Specific net water consumption (m ³ /tonne of carcass) for handling of casings and offal in chicken slaughterhouses.....	288
Figure 3.73: Specific net water consumption (m ³ /tonne of carcass) for vehicle washing in chicken slaughterhouses	289
Figure 3.74: Specific net water consumption (m ³ /animal) for chicken slaughterhouses (installation level).....	289
Figure 3.75: Specific net water consumption (m ³ /animal) for cleaning of floors/walls and equipment in chicken slaughterhouses.....	290
Figure 3.76: Specific net energy consumption (m ³ /animal) for defeathering in chicken slaughterhouses	290

Figure 3.77:	Specific net water consumption (m ³ /animal) for handling of casings and offal in chicken slaughterhouses.....	290
Figure 3.78:	Specific net water consumption (m ³ /animal) for vehicle washing in chicken slaughterhouses.....	291
Figure 3.79:	Specific waste water discharge per emission point (m ³ /tonne of carcass) in chicken slaughterhouses for all types of discharges and applied techniques to reduce water consumption.....	292
Figure 3.80:	Specific waste water discharge per emission point (m ³ /animal) in chicken slaughterhouses for all types of discharges and applied techniques to reduce water consumption.....	293
Figure 3.81:	Low-atmospheric-pressure stunning system.....	294
Figure 4.1:	Odour characteristics in a well-performing water scrubber/biofilter treatment system.....	306
Figure 4.2:	Odour characteristics in an insufficiently performing water scrubber/biofilter treatment system.....	307
Figure 4.3:	Odour characteristics in a well-performing thermal treatment system.....	308
Figure 4.4:	Odour characteristics in an insufficiently performing thermal treatment system.....	309
Figure 4.5:	Single-effect evaporator.....	315
Figure 4.6:	Multiple-effect evaporator.....	317
Figure 4.7:	Different markets for Category 1 and 2 products.....	323
Figure 4.8:	Different markets for Category 3 and edible fats.....	324
Figure 4.9:	Example of a Category 1 rendering plant flow diagram.....	327
Figure 4.10:	Example of a Category 3 rendering plant flow diagram.....	328
Figure 4.11:	Fat melting with the use of direct steam.....	336
Figure 4.12:	Fat melting with the use of indirect steam.....	337
Figure 4.13:	Typical process flow for a blood meal plant.....	339
Figure 4.14:	Overview of the blood processing to obtain plasma and haemoglobin.....	340
Figure 4.15:	Spray-dried plasma manufacturing process.....	342
Figure 4.16:	Typical process flow for a feather meal plant.....	343
Figure 4.17:	Specific net energy consumption (kWh/tonne of raw material) and applied techniques to reduce energy consumption in rendering, fat melting, blood and/or feather processing ...	349
Figure 4.18:	Specific net electricity and heat consumption (kWh/tonne of raw material) in rendering, fat melting, blood and/or feather processing.....	350
Figure 4.19:	Specific net energy consumption (kWh/tonne of raw material) for drying and cooking/sterilisation in rendering, fat melting, blood and/or feather processing.....	351
Figure 4.20:	Specific net energy consumption (kWh/tonne of raw material) for waste gas treatment in rendering, fat melting, blood and/or feather processing.....	351
Figure 4.21:	Specific net water consumption (m ³ /tonne of raw material) in rendering of animal by-products and/or edible co-products (installation level) (Part 1 of 2).....	352
Figure 4.22:	Specific net water consumption (m ³ /tonne of raw material) in rendering of animal by-products and/or edible co-products (installation level) (Part 2 of 2).....	352
Figure 4.23:	Specific net water consumption (m ³ /tonne of raw material) for boilers in rendering of animal by-products and/or edible co-products.....	353
Figure 4.24:	Specific net water consumption (m ³ /tonne of raw material) for cleaning of floors/walls and equipment in rendering of animal by-products and/or edible co-products.....	353
Figure 4.25:	Specific net water consumption (m ³ /tonne of raw material) for vehicle washing in rendering of animal by-products and/or edible co-products (rendering, fat melting, blood and/or feather processing).....	353
Figure 4.26:	Specific waste water discharge (m ³ /tonne of raw material) and applied techniques for reducing water consumption in rendering of animal by-products and/or edible co-products for all types of discharges (Part 1 of 2).....	354
Figure 4.27:	Specific waste water discharge (m ³ /tonne of raw material) and applied techniques for reducing water consumption in rendering of animal by-products and/or edible co-products for all types of discharges (Part 2 of 2).....	355
Figure 4.28:	Odour emissions (ou _E /m ³) and abatement techniques from rendering, fat melting, blood and/or feather processing (Part 1 of 2).....	357
Figure 4.29:	Odour emissions (ou _E /m ³) and abatement techniques from rendering, fat melting, blood and/or feather processing (Part 2 of 2).....	358
Figure 4.30:	TVOC emissions to air (mg/Nm ³) and abatement techniques from rendering, fat melting, blood and/or feather processing (Part 1 of 2).....	359
Figure 4.31:	TVOC emissions to air (mg/Nm ³) and abatement techniques from rendering, fat melting, blood and/or feather processing (Part 2 of 2).....	360
Figure 4.32:	NH ₃ emissions to air (mg/Nm ³) and abatement techniques for rendering, fat melting, blood and/or feather processing (Part 1 of 2).....	361

Figure 4.33: NH ₃ emissions to air (mg/Nm ³) and abatement techniques from rendering, fat melting, blood and/or feather processing (Part 2 of 2)	362
Figure 4.34: H ₂ S emissions to air (mg/Nm ³) and abatement techniques from rendering, fat melting, blood and/or feather processing (Part 1 of 2)	363
Figure 4.35: H ₂ S emissions to air (mg/Nm ³) and abatement techniques from rendering, fat melting, blood and/or feather processing (Part 2 of 2)	364
Figure 4.36: Processing steps of fishmeal and fish oil production	367
Figure 4.37: Specific net energy consumption (kWh/tonne of raw material) and applied techniques to reduce energy consumption in fishmeal and fish oil production (installation level)	370
Figure 4.38: Specific net electricity and heat consumption (kWh/tonne of raw material) in fishmeal and fish oil production (installation level).....	371
Figure 4.39: Specific net energy consumption (kWh/tonne of raw material) for cooking/sterilisation in fishmeal and fish oil production.....	371
Figure 4.40: Specific net energy consumption (kWh/tonne of raw material) for drying in fishmeal and fish oil production.....	372
Figure 4.41: Specific net water consumption (m ³ /tonne of raw material) in fishmeal and fish oil production (installation level)	372
Figure 4.42: Specific net water consumption (m ³ /tonne of raw material) for boilers in fishmeal and fish oil production	373
Figure 4.43: Specific net water consumption (m ³ /tonne of raw material) for vehicle washing in fishmeal and fish oil production.....	373
Figure 4.44: Specific waste water discharge (m ³ /tonne of raw material) and applied techniques for reducing water consumption in fishmeal and fish oil production for all types of discharges.....	374
Figure 4.45: Odour emissions (ou _E /m ³) and abatement techniques from fishmeal and fish oil production (Part 1 of 2)	375
Figure 4.46: Odour emissions (ou _E /m ³) and abatement techniques from fishmeal and fish oil production (Part 2 of 2)	376
Figure 4.47: TVOC emissions to air (mg/Nm ³) and abatement techniques from fishmeal and fish oil production	377
Figure 4.48: NH ₃ emissions to air (mg/Nm ³) and abatement techniques from fishmeal and fish oil production	378
Figure 4.49: Schematic representation of a four-stage self-circulating evaporator	380
Figure 4.50: Schematic representation of a falling film surplus heat evaporator.....	380
Figure 4.51: Production of gelatine and/or collagen peptides (installation level).....	386
Figure 4.52: Flow diagram for the demineralisation of bone to produce ossein for gelatine manufacturing	388
Figure 4.53: Production of gelatine from pig skins	394
Figure 4.54: Production of gelatine from hides	394
Figure 4.55: Production of gelatine from bones	395
Figure 4.56: Production of gelatine from bones – heat and pressure processes.....	395
Figure 4.57: Production of gelatine from fish skins.....	396
Figure 4.58: Specific net energy consumption (kWh/tonne of raw material) and applied techniques to reduce energy consumption in gelatine manufacturing (installation level).....	398
Figure 4.59: Specific electricity and heat consumption (kWh/tonne of raw material) in gelatine manufacturing (installation level)	399
Figure 4.60: Specific net energy consumption (kWh/tonne of raw material) for the drying process in gelatine manufacturing.....	399
Figure 4.61: Specific net water consumption (m ³ /tonne of raw material) in gelatine manufacturing (installation level).....	400
Figure 4.62: Specific net water consumption (m ³ /tonne of raw material) for boilers in gelatine manufacturing	400
Figure 4.63: Specific waste water discharge (m ³ /tonne of raw material) and applied techniques for reducing water consumption in gelatine manufacturing for all types of discharges.....	401
Figure 6.1: Process of heterotrophic microalgal cultivation	437
Figure 6.2: Schematic diagram of microbial fuel cells with PEM.....	439
Figure 6.3: Direct photooxidation.....	440
Figure 6.4: The different steps in superchilling	443
Figure 6.5: Flow of the hydrothermal liquefaction process	446
Figure 8.1: Country distribution of the participating SA installations	453
Figure 8.2: Number of SA installations by type of IED activities carried out.....	454
Figure 8.3: Different types of processes	455

Figure 8.4:	Distribution by type of activities processing animal by-products and/or edible co-products	455
Figure 9.1:	Flowchart of a slaughtering process	485
Figure 9.2:	Flowchart of a slaughtering process (unclean area).....	486
Figure 9.3:	Flowchart of a slaughtering process (clean area).....	487
Figure 9.4:	Flowchart of a rendering process.....	488
Figure 9.5:	Flowchart of a rendering process.....	488
Figure 9.6:	Flowchart of a rendering process.....	489
Figure 9.7:	Flowchart of emissions to air from a rendering installation	489
Figure 9.8:	Flowchart of emissions to air from a rendering installation	490

List of tables

Table 1.1:	KEIs for emissions to water included in the review of the SA BREF.....	1
Table 1.2:	KEIs for channelled emissions to air included in the review of the SA BREF	2
Table 2.1:	Reported biogas composition from the biodegradation of unspecified animal by-products.....	7
Table 2.2:	Reported sources of AOX emissions in waste water.....	36
Table 2.3:	Reported sources of chloride emissions in waste water	36
Table 2.4:	Information for each technique	55
Table 2.5:	Storage requirements for animal by-products in the Flemish region of Belgium	70
Table 2.6:	Various examples of heat recovery in the SA sector.....	84
Table 2.7:	Annual energy and cost savings per hose from lowering the water temperature from 71 °C to various lower temperatures	96
Table 2.8:	Operational data for a SBR at a 40 m ³ /d poultry slaughterhouse	121
Table 2.9:	Operational data for a SBR at a 100 m ³ /d poultry slaughterhouse	121
Table 2.10:	Operational data for a SBR at a 470 m ³ /d poultry slaughterhouse	121
Table 2.11:	Reported prices of SBR treatment plants in 6 slaughterhouses.....	122
Table 2.12:	Purification performance of a flotation plant during production and cleaning.....	134
Table 2.13:	Purification performance of a flotation plant using precipitation and flocculation agents	134
Table 2.14:	Influent/effluent data – for preliminary mechanical/physico-chemical waste water treatment after rendering	134
Table 2.15:	Cost and maintenance requirements for DAF treatment (750 m ³ /d effluent).....	136
Table 2.16:	Removal efficiencies of electrocoagulation vs general slaughterhouse waste water treatment techniques.....	137
Table 2.17:	Reduced emissions associated with cooling of blood prior to rendering	149
Table 2.18:	Reference values for the size and rating of biofilters	154
Table 2.19:	Odour emission values (ou _E /m ³) when a biofilter is used as an abatement technique in non-slaughterhouse installations	154
Table 2.20:	Reported performance data for a biotrickling installation.....	162
Table 2.21:	Odour emission values (ou _E /m ³) when a thermal oxidiser is used as an abatement technique in rendering installations.....	165
Table 2.22:	Cost elements for replacing an existing boiler with a thermal oxidiser.....	166
Table 3.1:	Categorisation of slaughterhouses according to their process automation level	179
Table 3.2:	Reduced consumption of water and detergents achieved without loss of cleanliness..	187
Table 3.3:	Quantities of detergent used in Danish pig slaughterhouses	188
Table 3.4:	Quantities of detergents and hypochlorite used in Danish slaughterhouses.....	188
Table 3.5:	Reported sources of Cu/Zn emissions in waste water	193
Table 3.6:	Comparison of chilling processes for pig carcass chilling	231
Table 3.7:	Specific waste water amounts and pollutant loads with and without de-sliming of bowels	261
Table 3.8:	Comparison of consumption data of different scalding methods (producers' information)	269
Table 3.9:	Comparison of actual consumption data of 'water circulation spray scalding' and 'steam scalding'	269
Table 3.10:	Economic differences of stunning procedures (water bath/head only, CAS, LAPS) ...	295
Table 4.1:	Animal by-products (including products intended for human consumption).....	302
Table 4.2:	Main techniques for odour treatment in installations processing animal by-products and/or edible co-products	304
Table 4.3:	Scores used for assessing the odour characteristics	305
Table 4.4:	Odour information for the samples taken in a well-performing water scrubber/biofilter treatment system	305
Table 4.5:	Odour information for the samples taken in a insufficiently performing water scrubber/biofilter treatment system.....	306
Table 4.6:	Odour information for the samples taken in a well-performing thermal treatment system	307
Table 4.7:	Odour information for the samples taken in an insufficiently performing thermal treatment system	308
Table 4.8:	Fat, moisture and ash composition of meat and bone meal.....	310
Table 4.9:	Composition of meat and bone meal.....	310
Table 4.10:	Optimum MBM composition (% mass dry) for gasification and thermal oxidation....	311

Table 4.11:	Typical chemical composition of syngas produced by the gasification of MBM.....	311
Table 4.12:	Emissions to air from combustion of animal fat in two steam boilers.....	315
Table 4.13:	Data for untreated waste water in a rendering plant seasonal differences	319
Table 4.14:	Different lines in the EFPRA EU Members	322
Table 4.15:	Different inspection patterns for blood uses	324
Table 4.16:	Classification of different blood products	325
Table 4.17:	Data for blood processing lines in EFPRA plants	325
Table 4.18:	Contrast between Category 1 or 2 and Category 3 raw material	330
Table 4.19:	Consumption and emissions associated with raw material reception, handling and tipping.....	330
Table 4.20:	Processing methods according to Commission Regulation (EU) No 142/2011	332
Table 4.21:	Consumption and emissions associated with raw material processing	333
Table 4.22:	Data of a stripping plant for ammonium (average values - daily mixed samples).....	365
Table 4.23:	Typical liming process schedule.....	389
Table 5.1:	BAT-associated emission levels (BAT-AELs) for direct discharges	422
Table 5.2:	BAT-associated emission levels (BAT-AELs) for indirect discharges	422
Table 5.3:	BAT-associated emission levels (BAT-AELs) for channelled emissions to air of dust, NO _x and SO _x from the combustion in thermal oxidisers of malodorous gases, including non-condensable gases	423
Table 5.4:	Indicative emission level for channelled CO emissions to air from the combustion in thermal oxidisers of malodorous gases, including non-condensable gases	424
Table 5.5:	BAT-associated environmental performance levels (BAT-AEPLs) for specific net energy consumption in slaughterhouses	427
Table 5.6:	BAT-associated environmental performance levels (BAT-AEPLs) for specific waste water discharge	428
Table 5.7:	Indicative emission level for refrigerant losses	429
Table 5.8:	BAT-associated environmental performance levels (BAT-AEPLs) for specific net energy consumption in installations processing animal by-products and/or edible co-products	430
Table 5.9:	BAT-associated environmental performance levels (BAT-AEPLs) for specific waste water discharge	430
Table 5.10:	BAT-associated emission levels (BAT-AELs) for channelled emissions to air of odour, organic compounds, NH ₃ and H ₂ S from rendering, fat melting, blood and/or feather processing	431
Table 5.11:	BAT-associated emission levels (BAT-AELs) for channelled emissions to air of odour, organic compounds and NH ₃ from fishmeal and fish oil production.....	432
Table 6.1:	Reduction of concentration of waste water pollutants after treatment by MFC	439
Table 7.1:	Key milestones of the SA BREF review process.....	449
Table 7.2:	Split views expressed.....	450

SCOPE

This BAT reference document (BREF) concerns the following activities specified in Annex I to Directive 2010/75/EU:

6.4. (a) Operating slaughterhouses with a carcass production capacity greater than 50 tonnes per day.

6.5. Disposal or recycling of animal carcasses or animal waste with a treatment capacity exceeding 10 tonnes per day.

6.11. Independently operated treatment of waste water not covered by Council Directive 91/271/EEC² when the main pollutant load originates from the activities covered by this document.

This document also covers:

- the processing of animal by-products and/or edible co-products (such as rendering and fat melting, feather processing, fishmeal and fish oil production, blood processing and gelatine manufacturing), covered by the activity description in points 6.4 (b) (i) and 6.5 of Annex I to Directive 2010/75/EU;
- the combustion of meat-and-bone meal and of animal fat;
- the combustion (e.g. in thermal oxidisers or steam boilers) of malodorous gases (originating from the activities covered by these BAT conclusions), including non-condensable gases;
- the incineration of carcasses if directly associated with the activities covered by this reference document;
- the preservation of hides and skins if directly associated with the activities covered by this reference document;
- the handling of casings and offal (viscera);
- composting and anaerobic digestion if directly associated with the activities covered by these BAT conclusions;
- the combined treatment of waste water from different origins provided that the main pollutant load originates from the activities covered by this document and that the waste water treatment is not covered by Council Directive 91/271/EEC¹.

This document does not cover the following:

- On-site combustion plants, not covered by the above bullet points, generating hot gases that are not used for direct contact heating, drying or any other treatment of objects or materials. This may be covered by the BREF for Large Combustion Plants (LCP) or by Directive (EU) 2015/2193 of the European Parliament and of the Council³.
- The production of food after the making of standard cuts for large animals or of cuts for poultry. This may be covered by the BREF for Food, Drink and Milk Industries (FDM).
- Landfill of waste. This is covered by Council Directive 1999/31/EC⁴. In particular, underground permanent and long-term storage (≥ 1 year before disposal, ≥ 3 years before recovery) are covered by Directive 1999/31/EC.

Other reference documents which could be relevant for the activities covered by this BREF include the following:

- Large Combustion Plants (LCP);
- Food, Drink and Milk Industries (FDM);

² Council Directive 91/271/EEC of 21 May 1991 concerning urban waste-water treatment (OJ L 135, 30.5.1991, p. 40).

³ Directive (EU) 2015/2193 of the European Parliament and of the Council of 25 November 2015 on the limitation of emissions of certain pollutants into the air from medium combustion plants (OJ L 313, 28.11.2015, p. 1).

⁴ Council Directive 1999/31/EC of 26 April 1999 on the landfill of waste (OJ L 182, 16.7.1999, p. 1).

Scope

- Common Waste Water and Waste Gas Treatment/Management Systems in the Chemical Sector (CWW);
- Waste Treatment (WT);
- Waste Incineration (WI);
- Tanning of Hides and Skins (TAN);
- Monitoring of Emissions to Air and Water from IED Installations (ROM);
- Economics and Cross-Media Effects (ECM);
- Emissions from Storage (EFS);
- Energy Efficiency (ENE);
- Industrial Cooling Systems (ICS).

The scope of this document does not include matters that only concern safety in the workplace or the safety of products because these matters are not covered by the Directive. They are discussed only where they affect matters within the scope of the Directive.

1 GENERAL INFORMATION ABOUT THE SA SECTOR

For the purposes of this document, SA sector refers to slaughterhouses, animal by-products and/or edible co-products industries.

The SA sector in the EU is diverse, with a wide range of processes and different configurations of industrial sites. Slaughtering activities are sometimes integrated with animal by-products processing and/or with activities relating to the food, drink and milk sector.

This chapter covers information applicable to the SA sector as a whole. More specific information on slaughterhouses is given in Chapter 3. More specific information on animal by-products and/or edible co-products industries is given in Chapter 4.

1.1 Key environmental issues

1.1.1 Emissions to water and to air

For emissions to water and to air, a key environmental issue (KEI) is caused by a process that emits a pollutant, which is monitored, and there are techniques able to prevent and/or reduce the emissions of the given pollutant.

The approach used to determine the KEIs is based on the following four criteria:

1. What is the environmental relevance of the pollutant?
2. What is the significance of the activity?
3. What is the potential for identifying new or additional techniques that would further significantly reduce pollution?
4. What is the potential for BAT-AELs that would significantly improve the level of environmental protection from current emission levels?

The KEIs were discussed during the kick-off meeting for the review of the SA BREF in June 2019. Based on the proposals made by the EIPPCB in the background paper and on the discussions which took place during the kick-off meeting for each pollutant, the technical working group (TWG) agreed to include in the review of the SA BREF the KEIs for emissions to water which are summarised in Table 1.1.

Table 1.1: KEIs for emissions to water included in the review of the SA BREF

(Groups of) Substance(s)	Type of discharge
Chemical oxygen demand (COD)	KEI for direct discharges only
Total organic carbon (TOC)	
Total suspended solids (TSS)	
Total nitrogen (TN)	
Total phosphorus (TP)	
<i>Source: [114, COM 2019]</i>	

In addition, a number of conclusions were reached for some pollutants or parameters, as follows:

- To collect data on TSS for indirect discharges from slaughterhouses as contextual information.
- To collect information on sources of copper and zinc emissions from slaughterhouses and on techniques to reduce copper and zinc emissions.
- To collect data on direct and indirect emissions of copper and zinc from slaughterhouses.

- To collect information on sources of AOX emissions from SA installations and on techniques to reduce AOX emissions.
- To collect data on direct and indirect emissions of AOX from SA installations.
- To collect bulk information on the selection and use of less harmful detergents in SA installations.
- To collect bulk information on emissions of microorganisms resistant to antimicrobials from slaughterhouses as well as on techniques to reduce such emissions.
- To collect data on the following substances and parameters not as KEIs but as contextual information:
 - temperature (for direct discharges only);
 - BOD₅ or BOD₇ (for direct discharges only);
 - ammonium-N (for direct discharges only);
 - pH (for direct and indirect discharges);
 - chloride (in slaughterhouses, in SA installations performing hide/skin salting and in gelatine manufacturing installations using bones, for both direct and indirect discharges);
 - sulphide and sulphate (in slaughterhouses and rendering installations, for direct and indirect discharges);
 - level of automation (for slaughterhouses).

The TWG agreed to include in the review of the SA BREF the KEIs for channelled emissions to air which are summarised in Table 1.2.

Table 1.2: KEIs for channelled emissions to air included in the review of the SA BREF

(Groups of) Substance(s)	Type of installation or process
Odour	All SA installations
H ₂ S	Rendering installations
HFC and HCFC	Slaughterhouses
Dust	<ul style="list-style-type: none"> • Installations processing animal by-products and/or edible co-products when thermal oxidation is used as an abatement technique.
SO _x	<ul style="list-style-type: none"> • Incineration of carcasses. • Combustion of meat-and-bone meal and animal fat. • Combustion of malodorous gases, including non-condensable gases (e.g. in thermal oxidisers or steam boilers), in SA installations.
NO _x	
NH ₃	<ul style="list-style-type: none"> • Rendering installations. • Incineration of carcasses. • Combustion of meat-and-bone meal and animal fat.
TVOC	<ul style="list-style-type: none"> • Combustion of malodorous gases, including non-condensable gases (e.g. in thermal oxidisers or steam boilers), in SA installations.
HCl	
Dioxins and furans	
Hg	<ul style="list-style-type: none"> • Incineration of carcasses. • Combustion of meat-and-bone meal.
Cd+Tl	
Sb+As+Pb+Cr+Co+Cu+Mn+Ni+V	
HF	<ul style="list-style-type: none"> • Incineration of carcasses.

Source: [114, COM 2019]

In addition, a number of conclusions were reached for some pollutants or parameters, as follows:

- To collect information on techniques to prevent and/or reduce diffuse odour emissions, including from waste water treatment plants.

- To collect information on the use of refrigerants without ozone depletion potential and with low global warming potential in slaughterhouses.
- To collect information on the consumption of refrigerants and techniques to prevent or reduce leakages in slaughterhouses through the questionnaires.
- To collect information on techniques to prevent or reduce dust emissions from installations processing animal by-products and/or edible co-products.
- Not to include dust as a KEI for slaughterhouses.
- Not to include NH₃ as a KEI for slaughterhouses.
- To include in the questionnaires CO emissions not as a KEI but as contextual information on the combustion efficiency of thermal oxidisers.
- To include in the questionnaires CO emissions from the incineration of carcasses not as a KEI but as contextual information on the combustion efficiency.
- To include in the questionnaires CO emissions not as a KEI but as contextual information on the combustion efficiency of:
 - the combustion of meat-and-bone meal and animal fat;
 - the combustion of malodorous gases, including non-condensable gases (e.g. in thermal oxidisers or steam boilers), in SA installations.
- Not to include noise as a KEI for SA installations.
- To collect information on techniques to prevent or reduce noise emissions from SA installations.

1.1.2 Consumption of energy and water and amount of waste water discharged

The TWG members agreed at the kick-off meeting upon the need to collect energy consumption data from specific processes and contextual information necessary to assess these data, in addition to the collection of water consumption data and the amount of waste water discharged at installation level. The TWG concluded on a closed list of specific processes representing the major sources of energy consumption in SA installations, and the major sources of water consumption for installations processing animal by-products and/or edible co-products. A number of conclusions were reached for these topics [114, COM 2019]:

- To include energy consumption at installation level as a KEI for SA installations.
- To include energy consumption as a KEI in slaughterhouses for the following specific processes:
 - cooling through all types of systems (electricity);
 - pig and poultry scalding (heat);
 - pig singeing (heat);
 - production of hot water for cleaning and disinfection (heat).
- To include energy consumption as a KEI in installations processing animal by-products and/or edible co-products for the following specific processes:
 - drying (in rendering, fishmeal and fish oil production, blood processing and gelatine manufacturing installations);
 - waste gas treatment.
- To include water consumption and waste water discharge as KEIs for SA installations.
- To include water consumption as a KEI in slaughterhouses, in particular for the following specific processes:
 - cleaning of floors and equipment (all animals);
 - sterilisation of slaughtering tools;
 - vehicle washing (all animals);
 - pig and poultry scalding;
 - poultry defeathering.
- To include water consumption as a KEI in installations processing animal by-products and/or edible co-products for the following specific processes:
 - cleaning of floors and equipment;

Chapter 1

- boilers including when using conventional fuels;
- vehicle washing.

2 GENERAL PROCESSES AND TECHNIQUES ACROSS THE SA SECTOR

2.1 Applied processes and techniques across the SA sector

This chapter addresses processes and techniques that are used across the whole SA sector.

Processes and techniques applied specifically in slaughterhouses are covered in Chapter 3. Processes and techniques applied specifically in animal by-products and/or edible co-products industries are covered in Chapter 4.

Examples of flowcharts for SA processes are given in Annex II.

2.1.1 Energy efficiency

In the SA sector, a number of common techniques are applied with the aim of reducing energy consumption. Most of these techniques are described in more detail in the ENE BREF [162, COM 2009]. Specific processes and techniques applying to slaughterhouses are given in Chapter 3. Specific processes and techniques applying to the animal by-products and/or edible co-products industries are given in Chapter 4.

It should be noted that energy efficiency is one of the key pillars of the EU's climate objectives, not only for the reduction of dependence on fossil fuels from abroad but also to increase security of supply and the use of renewable energy. In this direction, the 'energy efficiency first principle' is one of the key principles of the EU energy policy intended to ensure a secure, sustainable, competitive and affordable energy supply in the EU. The Commission proposed a clearer priority for the 'energy efficiency first principle' in the proposal for a recast Energy Efficiency Directive, adopted in July 2021 [208, COM 2021], accompanied by a formal recommendation to EU countries on the issue and detailed guidelines on its application, adopted in September 2021 [209, COM 2021].

The 'energy efficiency first principle' means taking utmost account of cost-efficient energy efficiency measures in shaping energy policy and making relevant investment decisions. It is a far-reaching guiding principle that can complement other EU objectives, in particular in the sustainability, climate neutrality and green growth areas.

2.1.2 Anaerobic digestion

Anaerobic digestion constitutes a possible method for treating materials resulting from SA industries and at the same time producing biogas and organic fertilisers or soil improvers. Some animal by-products and food waste are easily digested anaerobically and this gives a high yield of biogas. The carbon-containing material is degraded by microorganisms, thereby releasing biogas, comprising mainly CH₄ and CO₂. The digestion can be either wet or dry. Wet digestion allows normal pumps and stirrers to be used. The biogas is energy-rich and the digestion residues can often be used as organic fertilisers and soil improvers [40, Widell S. 2001]. It is also reported that the biogas production process changes nutrients to a form that is more readily absorbed by plants and that the spreading of biogas residues on land leads to fewer odour problems than spreading untreated manure [54, Gordon W. 2001].

Biogas cannot be produced from pure animal material because the nitrogen content is too high. Animal by-products must, therefore, be mixed with other organic matter to reduce the nitrogen content. In Denmark, approximately 75 % of the biomass resource for anaerobic digestion is animal manure, with the remainder mainly originating from food processing, including slaughterhouses, although some segregated domestic waste is also treated

[27, Danish Institute of Agricultural and Fisheries Economics 1999]. Animal by-products, manure and the sewage sludge from slaughterhouses can all be treated [26, Finnish Environment Institute and Finnish Food and Drink Industries' Federation 2001].

It should be noted that processing animal by-products by anaerobic digestion to generate biogas and fertilisers and/or soil improvers is a less preferable option than processing them by rendering according to the food waste hierarchy, as the same sustainability benefits will not be achieved. Processing animal by-products by rendering results in the transformation of animal proteins and fats to feed, fertiliser or renewable fuel. This contributes to the sustainability of agriculture and food production and reduces the overall carbon footprint of the animal-based food value chain [204, TWG 2021].

More information about the anaerobic digestion process can be found in the Waste Treatment BREF [179, Pinasseau et al. 2018].

Feedstock

The production of biogas from animal by-products is allowed for certain Category 2 materials and all Category 3 materials, as defined in the ABP Regulation (Regulation (EC) No 1069/2009), if they are treated as specified therein. For certain Category 2 by-products, sterilisation under prescribed conditions is required before biogas production. The resulting material can undergo pasteurisation as prescribed and can be used in biogas production. Category 3 by-products must be subject to the same prescribed pasteurisation/hygenisation treatment [119, EC 2009]. It is reported that the pasteurisation process assists the subsequent anaerobic digestion, especially with the digestion of fats.

It is reported that most meat and poultry by-products could be anaerobically digested in a biogas plant, with the exception of hard bone, which is considered to have too high an ash content. Provided that the material is sufficiently reduced in size, feathers, viscera, heads and feet, as well as liquid wastes such as blood and effluent sludge, could be used.

The treatment of manure, stomach and intestinal contents, bits of hide, waste blood and similar products in biogas installations is also possible [23, Nordic 2001].

Biogas production from solid digested and partially digested by-products such as rumen and stomach contents, screenings and solids-rich substrates such as rumen press water, flotation tailings, grease trap residues and the excrement and urine from the lairage, reportedly have a significant energy potential [42, Tritt W. P. and Schuchardt F. 1992]. There are, however, problems associated with the control of the formation of a floating scum, but these can be reduced by substitution with a wetter feedstock, e.g. pig slurry instead of rumen contents.

Loading and unloading

Odour can be minimised during the unloading of raw materials and the loading of solid products/by-products if undertaken in an enclosed area.

Production

A biogas production plant has reported the use of slaughterhouse by-products consisting of blood, stomachs and intestines, together with large quantities of process water. Previously, most of the process water was sent to a WWTP. To obtain a slower decomposition process, the materials are mixed with farmyard manure. Other forms of biological waste can also be used. All of the slaughterhouse by-products are pasteurised. After the heat treatment, the mix is allowed to decompose anaerobically. The bacteria culture converts the nutritious substrate to CH₄ and CO₂ [43, Linkoping Gas AB 1997].

A normal biogas composition is about 65 % CH₄ and 35 % CO₂, with small amounts of other gases. The biogas is saturated with moisture. CH₄ is the usable part of the biogas. In order for the CH₄ to be used as fuel, it has to be purified of CO₂, water vapour and small quantities of H₂S [43, Linkoping Gas AB 1997].

If the biogas is to be used as fuel for vehicles, it has to be cleaned, to a CH₄ content of at least 95 %. The energy content is about 9 kWh/m³. When biogas is used as a fuel for vehicles, the gas is compressed to a pressure of 20 MPa [43, Linköping Gas AB 1997].

Electricity can be produced from biogas, which can be utilised for own consumption and, in some countries, it can be integrated into the national power grid.

Table 2.1 shows the reported composition of biogas produced from unspecified animal by-products.

Table 2.1: Reported biogas composition from the biodegradation of unspecified animal by-products

Component	Volume (%)
CH ₄	40-70
CO ₂	30-60
Other gases, including	1-5
H ₂	0-1
H ₂ S	0-3
<i>Source:</i> [24, Det Norske Veritas 2001]	

Energy generation of 300 kWh/t of ABP processed has been reported. This represents a CH₄ production of 400 m³/h [24, Det Norske Veritas 2001].

To measure the energy recovery figures for CH₄ biogas produced from animal by-products, the CH₄ generated must be converted into electricity via a gas engine, taking into account the associated engine efficiency [24, Det Norske Veritas 2001].

For each unit of electricity generated, 1.5 units of waste heat are produced and recovered for production of on-site steam and hot water applications. In Denmark, this is used to provide district heating. If the biogas plant is close to major users of heat, such as industrial facilities or large municipal buildings, it may be possible to derive significant income from the waste heat. In general, the closer the users are to the plant, the more attractive it is to pipe the hot water to them [54, Gordon W. 2001].

The solid digestion residue contains nitrogen, phosphorus and potassium and can be used as a fertiliser. It is checked regularly to ensure the absence of *Salmonella*.

Problems

There may be problems with damage to vessels, due to gravel etc. ingested by cattle. The vessels may be glass-lined to avoid leaks, due to the very corrosive nature of products. Leaks lead to pressure losses which can interfere with boilers using the biogas.

It has been reported that sulphur in the biogas can cause problems in gas generators and that it should be removed to lengthen the life of the generator. It has also been reported that the sulphur can be added to the digestion residue to improve its plant nutrient value [54, Gordon W. 2001].

Abatement

The exhaust air from ventilation may require odour abatement or it may be burned in a burner. A flare can be used to prevent biogas from being discharged to air in cases where the capacity of the plant is insufficient or where there is overproduction or stoppage in a downstream power production unit. A temperature of at least 1 000 °C for at least 0.3 seconds in the burning zone guarantees low emissions, including odours. Abatement may also be required to remove H₂S.

2.1.3 Cleaning processes

Processing equipment and production installations are cleaned and disinfected periodically to comply with legal hygiene requirements. The frequency can vary considerably depending on the products and the processes. The aim of cleaning and disinfection is to remove product remnants, other contaminants and microorganisms.

Before starting the cleaning process, equipment is emptied as much as possible. Cleaning and disinfection can be carried out in various ways. Traditionally, they have been carried out manually. Cleaning-in-place (CIP), washing-in-place and cleaning-out-of-place are all expressions used for different forms of cleaning. Cleaning agents are delivered in a variety of ways, for example in bags, e.g. powdered cleaning agents, or in drums or bulk tankers. Many cleaning agents are potentially hazardous to the health and safety of the operator and systems can be provided to minimise the risk during storage, handling, use and disposal.

CIP is used especially for closed process equipment and tanks, whether stationary or small mobile processing units. The cleaning solution is pumped through the equipment and distributed by sprayers in vessels, tanks and reactors. The cleaning programme is mostly run automatically and applies the following steps; pre-rinse with water, circulation with a cleaning solution, intermediate rinse, disinfection, and final rinse with water. In automatic CIP systems, the final rinse water is often reused for pre-rinsing or may be recycled/reused in the process. In CIP, high temperatures of up to 90 °C are used, together with strong cleaning agents. CIP systems used for open systems like freezers are almost entirely automatic, except for some dry clean-up and opening of hatches. Temperatures for medium-pressure systems are normally below 50°C and the pressure is 10 bar to 15 bar [121, Giner-Santonja et al. 2019].

Cleaning-out-of-place is used when several of the machine's components need to be dismantled, usually before the manual or automated cleaning of the machine is started. The dismantled components are cleaned separately outside the machine. Forming machines are one example of this. There are augers, pistons, valves, forming plates and seals which all have to be dismantled before cleaning the machine. High-pressure jet cleaning, using gels and foams, can be carried out manually or automatically. The appropriate cleaning method involves an appropriate combination of cleaning factors such as water, temperature of the cleaning solution, cleaning agents, i.e. chemicals, and mechanical forces. Only mild conditions, with regard to temperature and cleaning agents, can be used for manual cleaning.

High-pressure jet cleaning and foam cleaning are generally applied for open equipment, walls and floors. Water is sprayed onto the surface to be cleaned, usually at a pressure of about 40 bar to 65 bar. Cleaning agents are injected into the water, at moderate temperatures of up to 60 °C. An important part of the cleaning action takes place due to mechanical forces [121, Giner-Santonja et al. 2019].

In foam cleaning, a foaming cleaning solution is sprayed onto the surface to be cleaned. The foam adheres to the surface. It stays on the surface for about 5 to 15 minutes and is then rinsed away with water. Foaming can be carried out both manually and automatically. Gel cleaning is similar to foam cleaning.

Sinner's circle is a model used to describe factors that influence the efficiency of a cleaning procedure. Sinner's circle describes the four main factors which influence cleaning efficiency. These four factors are cleaning time, temperature used, mechanics of cleaning and chemistry used. Ideally, these factors should influence the cleaning efficiency in equal parts. But in fact, in most cases, Sinner's circle is composed differently because each factor's contribution to the cleaning efficiency varies [121, Giner-Santonja et al. 2019].

How Sinner's circle is composed for the purpose of proving the cleaning efficiency is to be examined for each individual cleaning situation. Sinner's circle therefore provides a mathematical tool for calculating the proportion and intensity of each factor influencing cleaning efficiency.

2.1.3.1 Cleaning in slaughterhouses

For hygiene reasons, many slaughterhouse operators wash down process areas with hot water during breaks in production. All process equipment, containers, etc. must be cleaned and disinfected several times a day and after the day's work is finished in preparation for work starting again [33, COM 1991]. A typical cleaning routine at a slaughterhouse consists of the following steps.

Meat scraps, fat, etc. are squeegeed and shovelled up throughout the shift and collected for use/disposal according to the ABP Regulation (Regulation (EC) No 1069/2009). In some slaughterhouses, the meat scraps are hosed to the catchpots, if present, and drains. Some areas are also hosed down lightly at regular intervals during the shift. Hosing down uses water which becomes contaminated with solid material as well as FOG. At breaks in production, some drain catchpots are emptied into the waste bins. Each drainage point can have a grate cover and a catchpot, typically with a 4 mm mesh. Some slaughterhouses use a two-stage catchpot, comprising a coarse screen above a fine screen in an 'inverted top hat' arrangement.

Typically, at the ends of shifts, all process areas are washed using low-pressure hoses and all drain catchpots are emptied into the waste skip. A dilute proprietary detergent is then applied as foam onto all surfaces. After about 20 minutes or so, the surfaces are then rinsed with high-pressure hot water. In some slaughterhouses, a very dilute sanitising compound is sprayed onto all surfaces and left to dry. At many slaughterhouses, hooks, shackles, pans, etc. are cleaned *in situ* in a similar way.

Food-grade cleaning agents are usually used. There is a wide variety of cleaning materials available. Some have traditional chemical formulations and others are based on biotechnology. Some are formulated for specific or difficult cleaning problems, whereas others are intended for general use.

Hygiene requirements prohibit the use of HPLV sprays in meat areas during processing operations, as the atomised water can lead to airborne contamination. They can, however, be used for cleaning at the end of production. Good hygiene is vital for food safety reasons and there are strict EU and MS legal requirements. Using too much water can have negative hygiene consequences however. For instance, a very humid environment combined with the constant movement of machinery and the close proximity of carcasses to each other on the slaughter-line can lead to the spread of contamination by direct splashing and aerosols.

When the use of cleaning agents is reviewed at slaughterhouses, it is often found that changing to a more appropriate cleaning agent can reduce the amount of chemical required and in some cases can also improve hygiene standards. It is not unusual to find that higher doses than required are being used, especially during manual dosing. Automated dosing, if correctly set, has the advantage of stopping overdosing. It also has health and safety advantages because it minimises both personal exposure to hazardous substances and manual handling. In any case, adequate operator training and supervision are essential. There are, therefore, often opportunities to reduce the environmental impact of cleaning agents by selecting/substituting and applying them correctly.

In many slaughterhouses, it is common practice for the personnel involved in cleaning to remove floor grates and to flush meat scraps directly down the drain, believing that a subsequent screen or catchpot will trap all solids. In fact, when these meat scraps enter the waste water stream they are subject to turbulence, pumping and mechanical screening. This breaks the meat down and releases high COD substances into solution, along with colloidal and suspended fats and solids. Subsequent waste water treatment, either on site or at a municipal WWTP, can then be expensive. The breakdown of suspended fats and solids is increased if the water is hot. A review of cleaning practices may also identify if there is an excessive use of energy to heat water and possibly unnecessarily high water consumption.

Excess use of hypochlorites for cleaning slaughterhouses can cause elevated levels of AOX in soil and groundwater, if sewer pipes are not maintained properly. According to a Danish research project, groundwater in the surroundings of installations was polluted with an AOX content between 60 µg/l and 150 µg/l. The elevated content was mainly detected in the groundwater due to infiltration of rainwater on the slaughterhouse site [171, Jensen et al. 2016]. However, food safety issues must be taken into account when selecting cleaning chemicals.

2.1.3.2 Cleaning in installations processing animal by-products and/or edible co-products

To comply with regulatory hygiene standards, all process floor areas, equipment and containers must be washed down regularly, and vehicles must be washed inside and out before leaving the site after a delivery.

All cleaning facilities must be sited to ensure that stored product is not contaminated via waste water splashes or run-off. The type of facilities used will depend on the situation and may include:

- steam cleaner;
- handheld hose or automated cleaning system;
- chemical disinfection using an approved disinfectant.

Steam sterilisation may be used for routine cleaning and disinfection but there must be facilities to disinfect with approved chemicals when necessary. Wheel washes or manual disinfectant sprays are satisfactory.

These practices with the use of approved disinfectants are designed to ensure that there is no potential for disease to be spread in waste water derived from cleaning operations when treated and discharged into the environment. Furthermore, disinfection of raw material handling areas, vehicles and equipment also minimises the potential for disease to be spread from the air extracted from buildings housing raw materials.

Cleaning can be resource-intensive – with significant water, energy and chemical consumption. Unlike slaughterhouses, cleaning is performed throughout the shift by site personnel rather than by specialist contractors [160, EFPR 2019].

2.1.3.3 Use of chemicals

Chemical consumption in the SA sector varies between sites and may depend on several factors (e.g. plant layout, throughput capacity, abatement techniques). Legislative cleaning requirements result in a significant use of chemicals (see Section 3.2.2.1 for information on the consumption of chemicals in slaughterhouses). Apart from cleaning and disinfection, chemicals are also used for waste water treatment (e.g. pH control, flocculation), odour abatement (e.g. chemical scrubbing, activated carbon, biofilters' pH control), boiler feed water treatment, cooling water treatment and other uses not directly related to production. The use of process chemicals is generally related to limited amounts of product additives.

Animal diseases (e.g. avian influenza and potentially African swine fever) may result in mandatory veterinary cleaning, resulting in an increase of the amount and type of chemicals used. This may also result in higher water and energy consumption.

2.1.4 Waste water treatment

Preventing animal material entering the waste water stream in the first place is the best way of minimising effluent loading. Some slaughterhouse managers have carefully assessed operations

involving cutting and trimming and have designed or modified their installations and equipment to physically intercept animal by-products such as meat wastes and viscera before they enter the drains. Training personnel can bring benefits beyond just improving environmental performance. Cleaning up any dropped scraps during the processing time and emptying drain catchpots, then replacing them before beginning to clean an area, does not just reduce the overall effluent load, it also reduces the risk of individuals slipping, one of the main causes of work-related lost time accidents in the meat industry.

Good management of the selection and use of cleaning chemicals is essential to ensure that they do not kill the microorganisms in the WWTP [4, WS Atkins-EA 2000], [13, WS Atkins-EA 2000].

The spillage of high-strength organic liquids from overflow from the effluent treatment plant is potentially one of the most polluting events at slaughterhouses. To prevent overfilling and potential spillage into local watercourses, effluent tanks can be fitted with high level alarms and devices to prevent automatic overfilling. Many DAF plants continuously monitor their effluent quality and automatically divert effluent to standby storage if the DAF plant breaks down [4, WS Atkins-EA 2000].

Primary waste water treatment

The mechanical stages in the waste water treatment are usually implemented before any mixing or equalisation takes place. Waste water from process areas at slaughterhouses is normally screened, both to remove organic debris such as hairs, some fats, tissue, meat scraps, paunch and gross solids and to avoid blockages in the WWTP. Apart from the by-products of actual slaughtering, the waste water generally contains primary solids produced during transport, lairage and the washing of stomachs and intestines. These include straw, faeces, urine and intestinal contents. Secondary solids, e.g. sieve and rake material, fats and floating matter, are produced during waste water and air treatment. Solids removal, e.g. by screening, may therefore be required at the end of the WWTP, as well as at the beginning.

In the rendering industry, sludge catchers, fat separators, sieves, micro-strainers and settlement tanks are normally used. Undissolved animal matter, such as fat and fat particles, meat residues, hair, bristles and mineral admixtures from the process water can be conveyed back into the production process in certain types of rendering plants (processing Category 1 and 2 raw materials). Fat separation can be difficult, as the animal fat in the waste water can exist in a very fine form. This is especially true if the water temperatures are high and when the waste water contains tensides. High pH values also impair the fat separation, due to saponification.

In some cases, some soluble colloidal substances and phosphates are removed from the waste water by adding coagulation and flocculation chemicals, e.g. iron salts, aluminium salts and polyelectrolytes, to form precipitates [4, WS Atkins-EA 2000], [51, Metcalf and Eddy 1991].

Other flotation methods include dispersion flotation, which involves the injection of ‘dispersion water’ produced with compressed air, or mechanical flotation, where the water is agitated to produce air bubbles.

The oils, fats and greases and other solids removed may be sent for rendering, if the fat content is high, or to anaerobic digestion for biogas production. Otherwise they may be sent for landspreading, if they have a high nutrient content [50, Durkan J. 2001].

Secondary waste water treatment

Aerobic oxidation – activated sludge

The aerobic oxidation process using activated sludge involves the production of an activated mass of microorganisms, capable of stabilising a waste aerobically in an aerated tank. During endogenous respiration bacterial cells react with oxygen to produce CO₂, water and energy.

The addition of oxygen to the system is essential to the process for several reasons, including the oxidation of the organic matter and nutrients and for maintaining good physical mixing.

The organic matter acts as the essential energy source for the microorganisms, but they also require inorganic nutrients for their growth. Aerobic oxidation is an effective technique for slaughterhouse waste water treatment. It removes principal inorganic nutrients such as nitrogen and phosphorus (in small quantities for cell growth) as well as minor nutrients such as copper and zinc.

There are other available techniques for aerobic treatment, which use the same principle, e.g. the moving bed trickling filter, on which the sludge is coated on plastic spheres. The waste water flows over the spheres and the system reportedly also operates as an odour abatement technique [59, The Netherlands 2002].

Anaerobic digestion

The anaerobic treatment of waste water is widely used, although it is favoured by some and not by others. Reported advantages include the considerable reduction of the concentration of impurities in the water, low excess sludge production, biologically stable excess sludge and the potential collection of the energy-rich biogas which is produced [42, Tritt W. P. and Schuchardt F. 1992]. Anaerobic treatment is especially suitable as a pretreatment for waste water which has a high organic load, prior to aerobic treatment.

Anaerobic degradation only converts the carbon-based impurities, measured as BOD levels. The nitrogen compounds are still left in the water after cleaning [23, Nordic 2001]. It is therefore considered by some not to be a realistic option for final waste water treatment [59, The Netherlands 2002] and only suitable as a pretreatment prior to aerobic treatment. The process does, however, reduce the pathogenic content of the waste water [51, Metcalf and Eddy 1991].

Biosolids produced by the treatment plant may for example be dewatered prior to landspreading as a soil conditioner or digested to yield biogas. Limitations on landspreading are leading to an increased trend towards the incineration of sludges [62, Germany 2002]. Sludge storage, handling and spreading can lead to odour problems. As well as managing the usual operational issues related to activated sludge plants, such as the development of bulking sludges or carrying excessive biomass inventories, particular problems may be experienced with slaughterhouse effluents, which can cause the formation of biologically stable foam; or they may contain biocidal substances capable of inhibiting microbial activity [4, WS Atkins-EA 2000].

Tertiary waste water treatment

Tertiary treatments, such as filtration, coagulation or precipitation, are sometimes used as a final cleaning step for the treated effluent, prior to discharge to a watercourse.

The sludge produced may be used or disposed of in a variety of ways including the following: biogas production; composting, mixed with other biodegradable material, such as paunch and blood; rendering followed by incineration and by direct incineration. The processing of sludge can cause odour problems, which are exacerbated by mixing and aerosol production. Energy is required to remove water, by centrifugation or pressing for example [32, Sweeney L. 2001].

2.2 Current consumption and emission levels across the SA sector

2.2.1 Emissions to water

In the following sections, figures showing emissions from different points of release from the data collection are presented. It should be noted that some emission points could be related to non-process water streams (e.g. sanitary water, run-off water).

2.2.1.1 Chemical oxygen demand (COD)

COD is commonly used to indirectly measure the amount of organic compounds in water by measuring the mass of oxygen needed for their total oxidation to carbon dioxide. The most widespread COD monitoring methods use dichromate as an oxidising agent and mercury salts to suppress the influence of inorganic chloride. Methods that do not use mercury compounds are also available. COD has to be considered in relation to TSS since the TSS removal efficiency affects the performance achieved with respect to COD. For economic and environmental reasons, COD is being replaced to some extent by TOC.

Performance of reference installations

Often 24-hour composite samples are taken on a daily, weekly or monthly basis.

Figure 2.1 and Figure 2.2 show reported data (from installations participating in the data collection, for the years 2016 to 2018) for COD emissions to water from slaughterhouses for direct discharges, as well as the applied abatement techniques.



Figure 2.1: COD emissions to water (mg/l) from slaughterhouses (direct discharges) (Part 1 of 2)



Figure 2.2: COD emissions to water (mg/l) from slaughterhouses (direct discharges) (Part 2 of 2)

Figure 2.3 and Figure 2.4 show reported data (from installations participating in the data collection, for the years 2016 to 2018) for COD emissions to water from installations processing

Chapter 2

animal by-products and/or edible co-products for direct discharges, as well as the applied abatement techniques.



Figure 2.3: COD emissions to water (mg/l) from installations processing animal by-products and/or edible co-products (direct discharges) (Part 1 of 2)



Figure 2.4: COD emissions to water (mg/l) from installations processing animal by-products and/or edible co-products (direct discharges) (Part 2 of 2)

2.2.1.2 Total organic carbon (TOC)

Total organic carbon (TOC) analysis is used to directly measure the amount of organic compounds in water. The most widespread methods use a combustion chamber to completely oxidise the organic substances to carbon dioxide which is then measured by spectrometry. Inorganic carbon is not included in TOC. Identifying changes in the normal/expected TOC concentrations can be a good indicator of potential threats to a waste water treatment system. Various online TOC analysers exist. There is a tendency to replace COD with TOC for economic and ecological reasons.

Performance of reference installations

Often 24-hour composite or time-proportional samples are taken on a monthly basis.

Figure 2.5 shows reported data (from installations participating in the data collection, for the years 2016 to 2018) for TOC emissions to water from SA installations for direct discharges, as well as the applied abatement techniques.



Figure 2.5: TOC emissions to water (mg/l) from SA installations (direct discharges)

2.2.1.3 Biochemical oxygen demand in 5 days (BOD₅)

BOD₅ measures the amount of dissolved oxygen required or consumed in 5 days at a constant temperature for the microbiological decomposition (oxidation) of organic material in water. The concentration in the effluent is generally a more pertinent parameter than the abatement efficiency.

The parameters COD and TOC can be determined more quickly than BOD₅. Furthermore, the use of BOD₅ as a parameter to describe the efficiency of biological treatment has some disadvantages such as:

- the monitoring method used is not very accurate considering reproducibility and methodology dependence (dilution method versus respirometer for example);
- the analytical result depends on the local conditions of the laboratory, such as the inoculum used for the test;
- the BOD₅ measurement does not allow for any prediction of the performance within the WWTP; it only provides an indication as to whether the waste water is easily degradable to a certain rate.

Performance of reference installations

Often 24-hour composite samples are taken on a weekly or monthly basis.

Figure 2.6 and Figure 2.7 show reported data (from installations participating in the data collection, for the years 2016 to 2018) for BOD₅ emissions to water from SA installations for direct discharges, as well as the applied abatement techniques.



Figure 2.6: BOD₅ emissions to water (mg/l) from SA installations (direct discharges) (Part 1 of 2)



Figure 2.7: BOD₅ emissions to water (mg/l) from SA installations (direct discharges) (Part 2 of 2)

2.2.1.4 Total suspended solids (TSS)

There are some reasons to link the analysis of TSS with other parameters. If BOD/COD/TOC removal functions poorly, TSS emissions may be affected. Conversely, high TSS values can correlate with or cause high concentrations of other parameters, namely BOD, TOC or COD, total phosphorus and total nitrogen.

It is possible to have higher TSS values in the effluent than in the influent, for example due to the growth of biomass during biological treatment or due to the precipitation of compounds during physico-chemical treatment. In most cases, it therefore does not make sense to calculate abatement efficiencies for the WWTP.

Performance of reference installations

Often 24-hour composite samples are taken on a daily or monthly basis.

Figure 2.8 and Figure 2.9 show data (from installations participating in the data collection, for the years 2016 to 2018) for TSS emissions to water from SA installations for direct discharges, as well as the applied abatement techniques.



Figure 2.8: TSS emissions to water (mg/l) from SA installations (direct discharges) (Part 1 of 2)

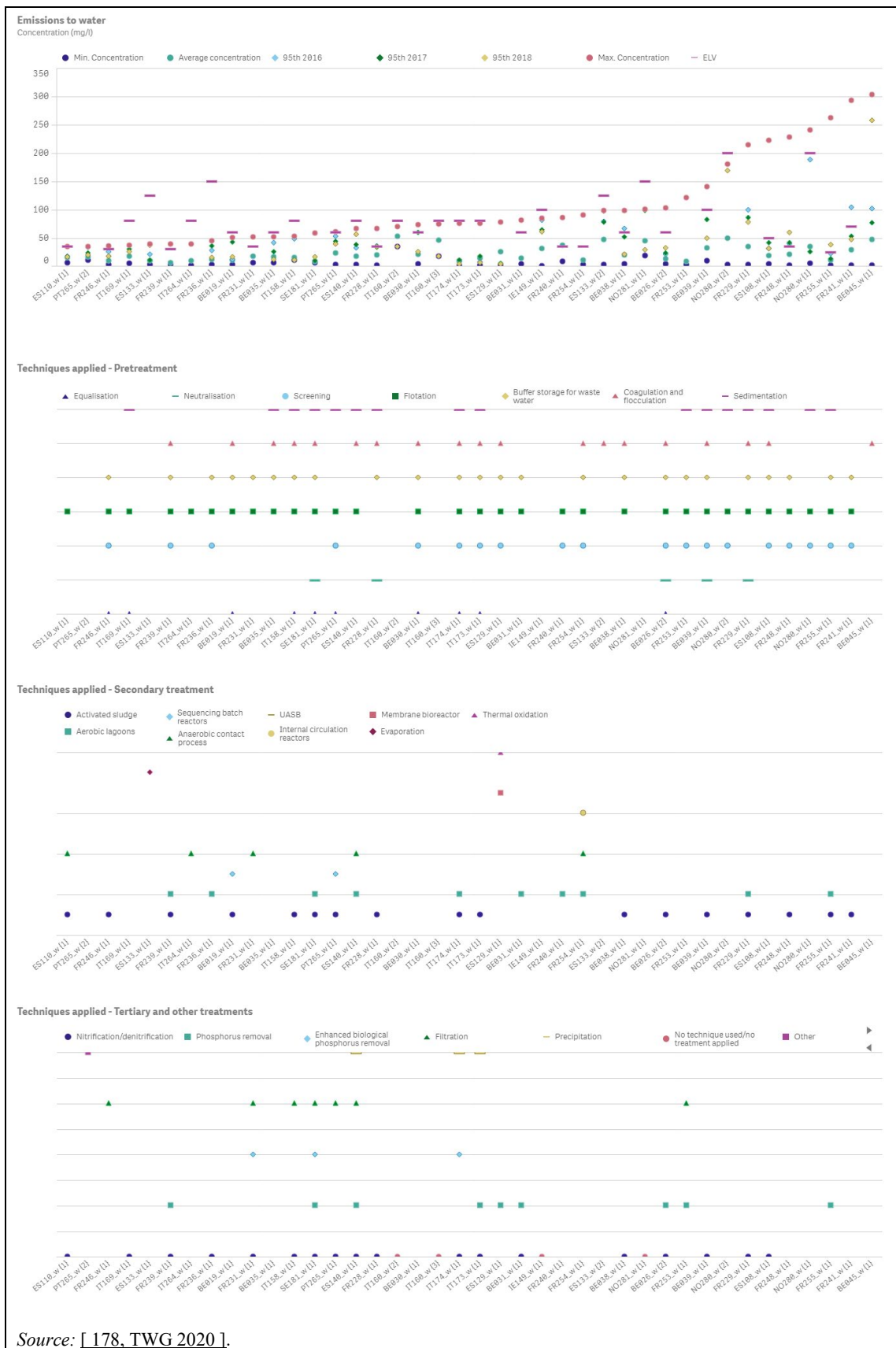

Figure 2.9: TSS emissions to water (mg/l) from SA installations (direct discharges) (Part 2 of 2)

2.2.1.5 Total nitrogen (Total N)

The parameter total nitrogen (Total N) includes free ammonia and ammonium (NH₄-N), nitrites (NO₂-N), nitrates (NO₃-N) and organic nitrogen compounds. Dissolved elementary nitrogen (N₂) is not included. Total N is frequently measured by combustion with subsequent analysis of nitrogen oxides via chemiluminescence (i.e. total nitrogen bound = TN_b, e.g. according to EN 12260), or by oxidation with peroxodisulphate with subsequent wet-chemical analysis of nitrate (Koroleff method, e.g. according to EN ISO 11905-1). Total N can also be determined by summing up the individual concentrations of total Kjeldahl nitrogen (TKN), NO₂-N and NO₃-N.

Performance of reference installations

Often 24-hour composite samples are taken on a weekly or monthly basis.

Figure 2.10 and Figure 2.11 show reported data (from installations participating in the data collection, for the years 2016 to 2018) for Total N emissions to water from SA installations for direct discharges, as well as the applied abatement techniques.



Figure 2.10: Total N emissions to water (mg/l) from SA installations (direct discharges) (Part 1 of 2)



Figure 2.11: Total N emissions to water (mg/l) from SA installations (direct discharges) (Part 2 of 2)

2.2.1.6 Total phosphorus (Total P)

Phosphorus is present in waste water in inorganic and organic forms. The inorganic forms are orthophosphates (i.e. $\text{HPO}_4^{2-}/\text{H}_2\text{PO}_4^-$) and polyphosphates. Organically bound phosphorus is usually of minor importance. Polyphosphates can be used as a means of controlling corrosion. Phosphorus discharge has to be controlled in the same way as nitrogen discharge in order to avoid eutrophication of a surface water body.

Performance of reference installations

Often 24-hour composite samples are taken on a weekly or monthly basis.

Figure 2.12, Figure 2.13 and Figure 2.14 show reported data (from installations participating in the data collection, for the years 2016 to 2018) for Total P emissions to water from SA installations for direct discharges, as well as the applied abatement techniques.



Figure 2.12: Total P emissions to water (mg/l) from SA installations (direct discharges) (Part 1 of 3)



Figure 2.13: Total P emissions to water (mg/l) from SA installations (direct discharges) (Part 2 of 3)

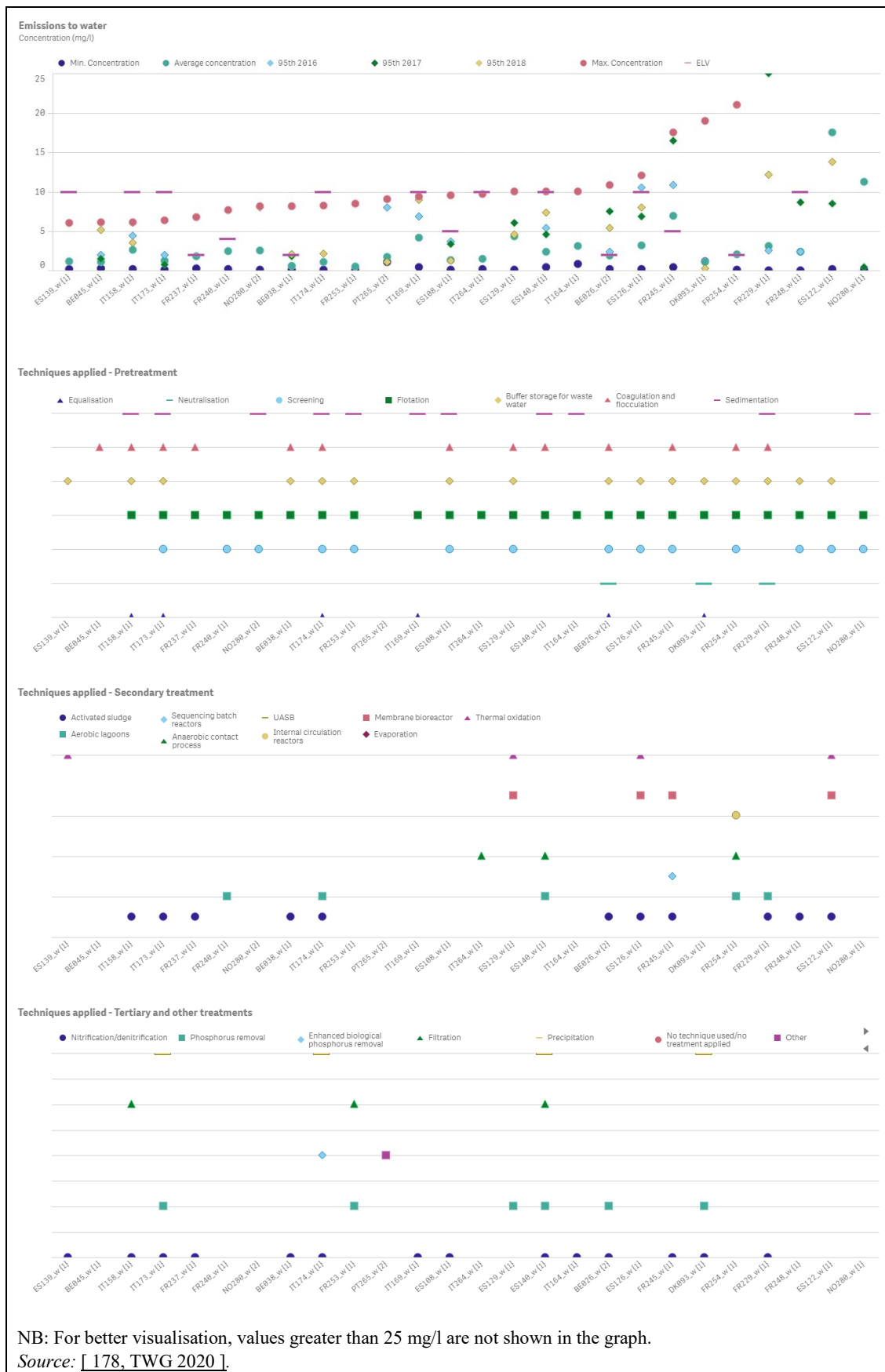

Figure 2.14: Total P emissions to water (mg/l) from SA installations (direct discharges) (Part 3 of 3)

2.2.1.7 Adsorbable organically bound halogens (AOX)

AOX is a sum parameter which indicates the overall level of organohalogen compounds (chlorine, bromine and iodine) in water samples. It is important as many organohalogen compounds are toxic (especially the fat-soluble chlorinated group – dioxins, furans and polychlorinated phenolic compounds) and/or persistent. However, as a sum parameter, AOX does not provide information on the chemical structure of organohalogen compounds present or on their toxicity. The AOX method has the advantage that it is a relatively simple measurement if it is compared with the alternative methods of measuring levels of individual compounds which are complex and require costly equipment.

Performance of reference installations

Often 24-hour composite samples are taken on a monthly or yearly basis.

Figure 2.15 shows reported data (from installations participating in the data collection, for the years 2016 to 2018) for AOX emissions to water from SA installations for direct discharges, as well as the applied abatement techniques.



Figure 2.15: AOX emissions to water (mg/l) from SA installations (direct discharges)

Figure 2.16 shows reported data (from installations participating in the data collection, for the years 2016 to 2018) for AOX emissions to water from SA installations for indirect discharges, as well as the applied abatement techniques.



Figure 2.16: AOX emissions to water (mg/l) from SA installations (indirect discharges)

The use of sodium hypochlorite as a cleaning agent has been reported as a common source of AOX emissions to water [178, TWG 2020]. It has also been reported that, in a small experiment in two Danish pig slaughterhouses, no correlation between the use of hypochlorite and AOX emissions to water was evident [212, TWG 2022].

Sodium hypochlorite is also used in chemical scrubbers for odour treatment but low concentrations are generally used and the volume of spent scrubber liquor drained as waste water is relatively low. Moreover, scrubber liquor control is generally automated, which means there are not intermittent spikes of high volumes of spent scrubbing liquor sent to the waste water treatment plant [207, TWG 2023].

In Table 2.2 some specific reported sources of AOX emissions in waste water are presented.

Table 2.2: Reported sources of AOX emissions in waste water

Installation	Type of installation	AOX source mentioned in permit
BE019	Slaughterhouse (pigs)	Use of bleach or active chlorine in cleaning activities and in cooling towers as a disinfectant
BE030		Disinfectants with chlorine
BE035		Disinfectants & cleaning products
<i>Source: [207, TWG 2023]</i>		

An additional reported source is kosher production of meat, e.g. first ritual cleaning with salt water before slaughtering of poultry [207, TWG 2023].

2.2.1.8 Chloride

In Table 2.3 some specific reported sources of chloride emissions in waste water are presented.

Table 2.3: Reported sources of chloride emissions in waste water

Installation	Type of installation	Chloride source mentioned in permit
BE026	Slaughterhouse (pigs)	Chlorinating groundwater
BE030		- Chlorinated products for cleaning and disinfection - Chlorination of treated water / effluent (with NaOCl) for use as cleaning water or cooling water - Use of FeCl ₃ in waste water treatment
BE035		- Use of FeCl ₃ in waste water treatment - Recuperation of water / chlorination of effluent for reuse
BE033	Slaughterhouse (poultry)	- Chlorinated disinfectants - Use of FeCl ₃ in waste water treatment
BE038	Gelatine manufacturing	- Use of FeCl ₃ in waste water treatment - Use of NaOCl and HCl
BE039		- Treatment of ossein - Salting of skins
BE025	Rendering	Use of FeCl ₃ or AlCl ₃ for P removal
BE027		Treatment of effluent for recuperation
<i>Source: [207, TWG 2023]</i>		

2.2.2 Emissions to air

2.2.2.1 Emissions to air from combustion in boilers of malodorous gases, including non-condensable gases

2.2.2.1.1 Dust

Figure 2.17 shows reported data (from installations participating in the data collection, for the years 2016 to 2018) for channelled dust emissions to air from combustion in boilers of malodorous gases, including non-condensable gases, in SA installations. No correction for reported O₂ reference level has been applied. Values have been reported at various O₂ contents.

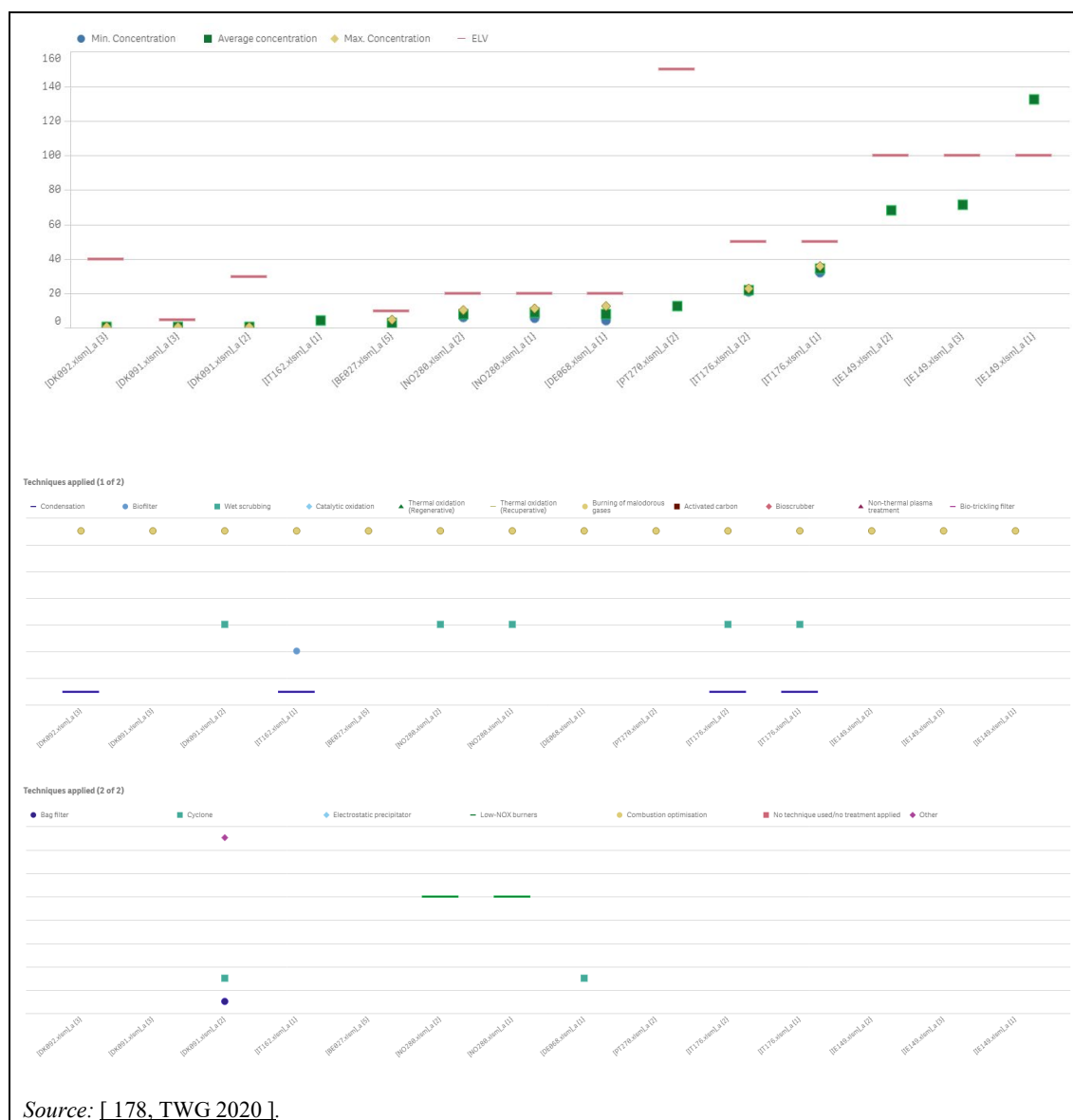

Source: [178, TWG 2020].

Figure 2.17: Dust emissions to air (mg/Nm³) from combustion in boilers of malodorous gases, including non-condensable gases, in SA installations

Figure 2.18 shows reported data (from installations participating in the data collection, for the years 2016 to 2018) for channelled dust emissions to air from combustion in boilers of malodorous gases, including non-condensable gases, in SA installations. Values have been corrected to a reference O₂ level of 3 %.

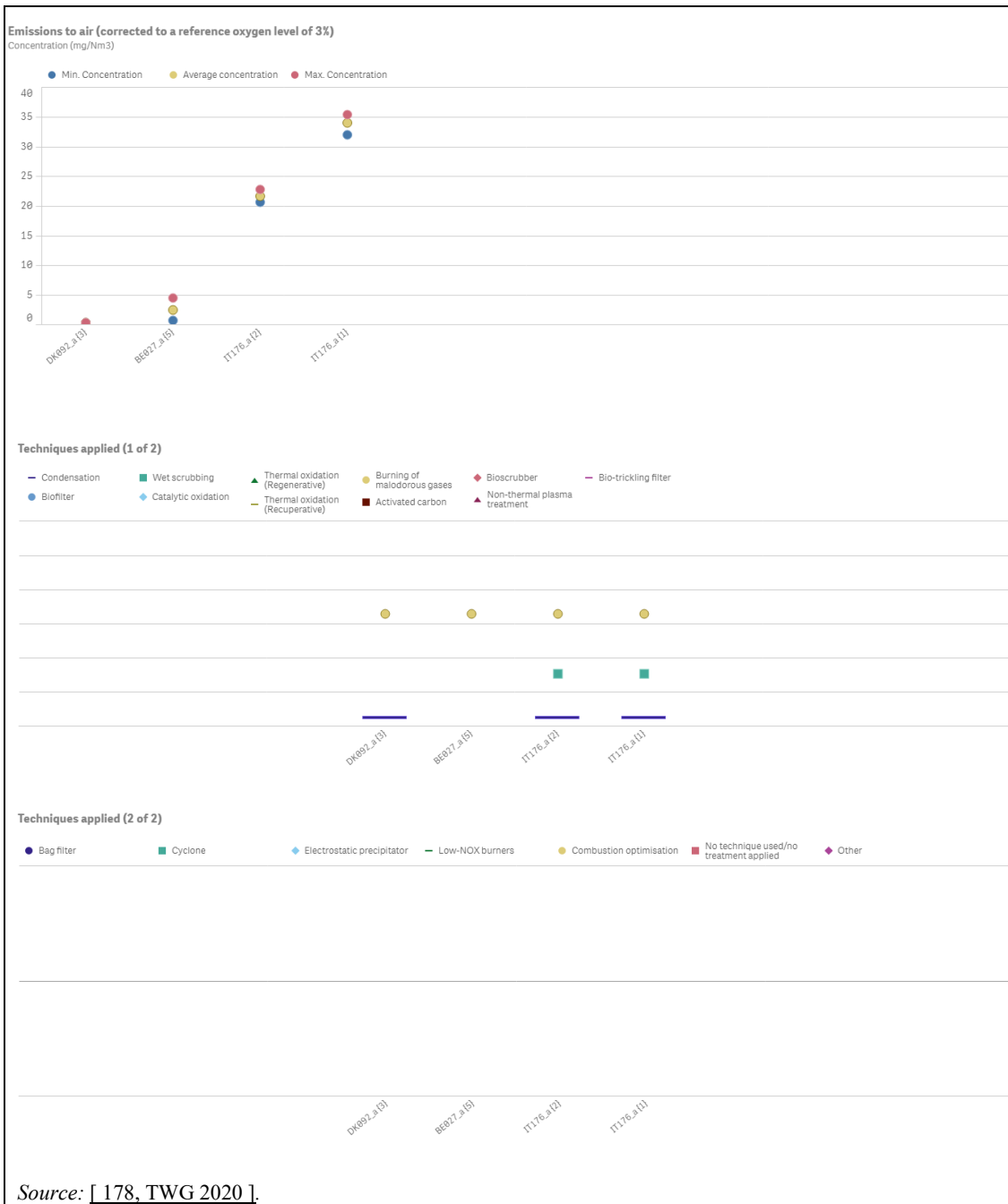

Figure 2.18: Dust emissions to air (mg/Nm³) from combustion in boilers of malodorous gases, including non-condensable gases, in SA installations (values corrected to 3 % O₂)

Installation IE149 (not shown in the graph) reported average dust emission values (at a reference O₂ level of 3 %) from three emission points between 16.83 mg/Nm³ and 141.93 mg/Nm³.

2.2.2.1.2 NO_x

Figure 2.19 shows reported data (from installations participating in the data collection, for the years 2016 to 2018) for channelled NO_x emissions to air from combustion in boilers of malodorous gases, including non-condensable gases, in SA installations. No correction for reported O₂ reference level has been applied. Values have been reported at various O₂ contents.

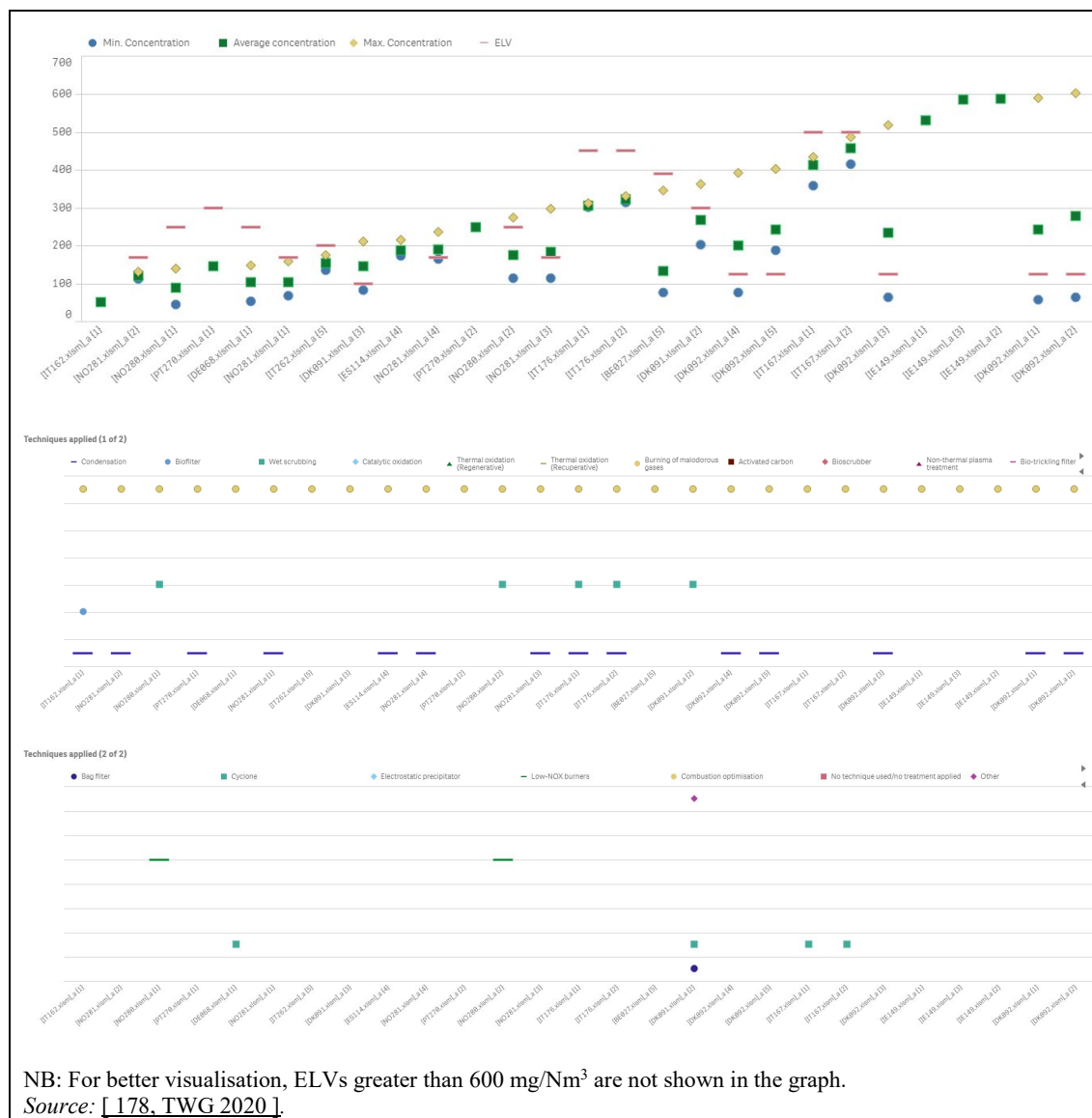

Figure 2.19: NO_x emissions to air (mg/Nm³) from combustion in boilers of malodorous gases, including non-condensable gases, in SA installations

Figure 2.20 shows reported data (from installations participating in the data collection, for the years 2016 to 2018) for channelled NO_x emissions to air from combustion in boilers of malodorous gases, including non-condensable gases, in SA installations. Values have been corrected to a reference O₂ level of 3 %.

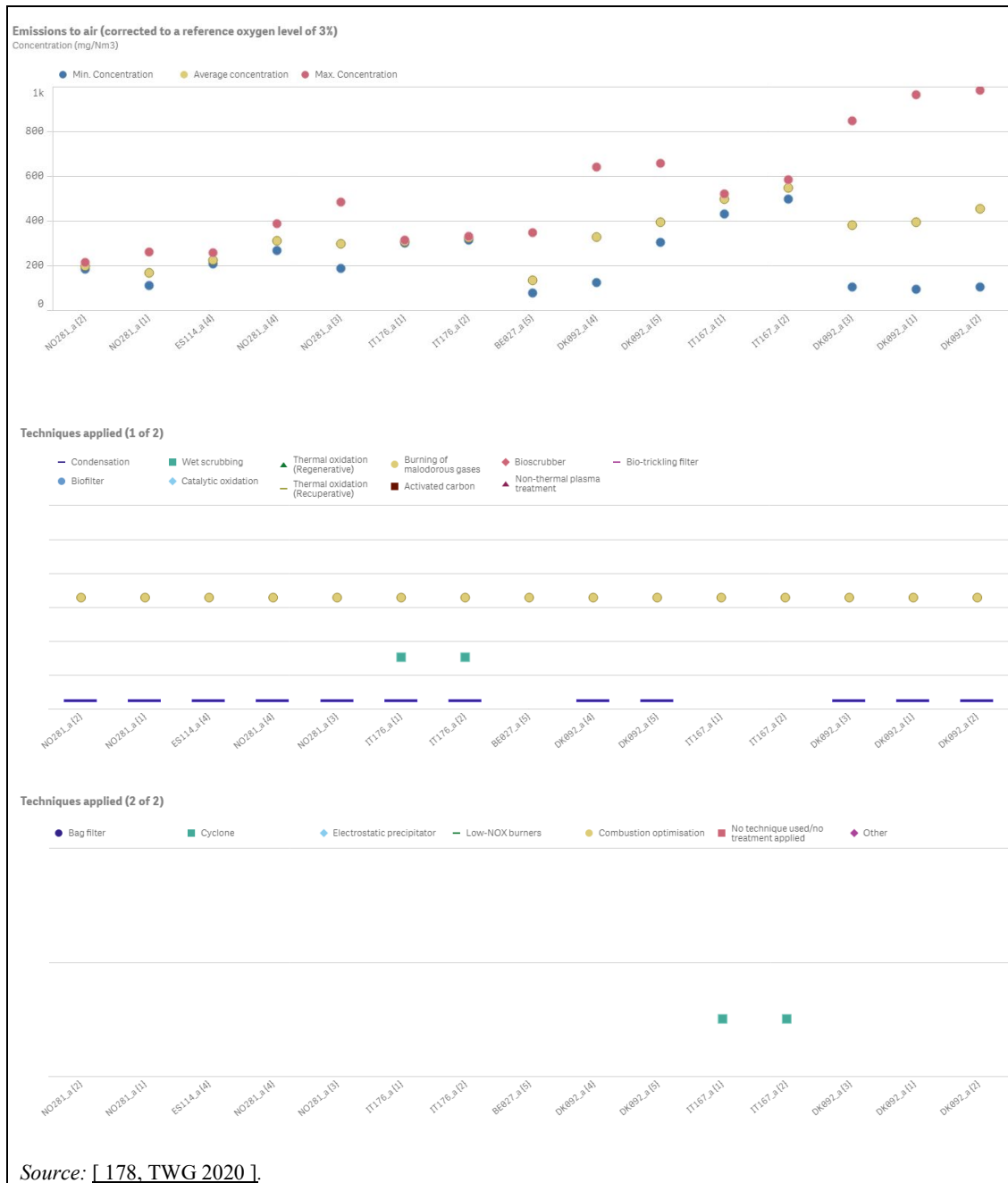

Figure 2.20: NO_x emissions to air (mg/Nm³) from combustion in boilers of malodorous gases, including non-condensable gases, in SA installations (values corrected to 3 % O₂)

Installation IE149 (not shown in the graph) reported average NO_x emission values (at a reference O₂ level of 3 %) from three emission points between 529.53 mg/Nm³ and 805.30 mg/Nm³.

2.2.2.1.3 SO_x

Figure 2.21 and Figure 2.22 show reported data (from installations participating in the data collection, for the years 2016 to 2018) for channelled SO_x emissions to air from combustion in boilers of malodorous gases, including non-condensable gases, in SA installations. No correction for reported O₂ reference level has been applied. Values have been reported at various O₂ contents.

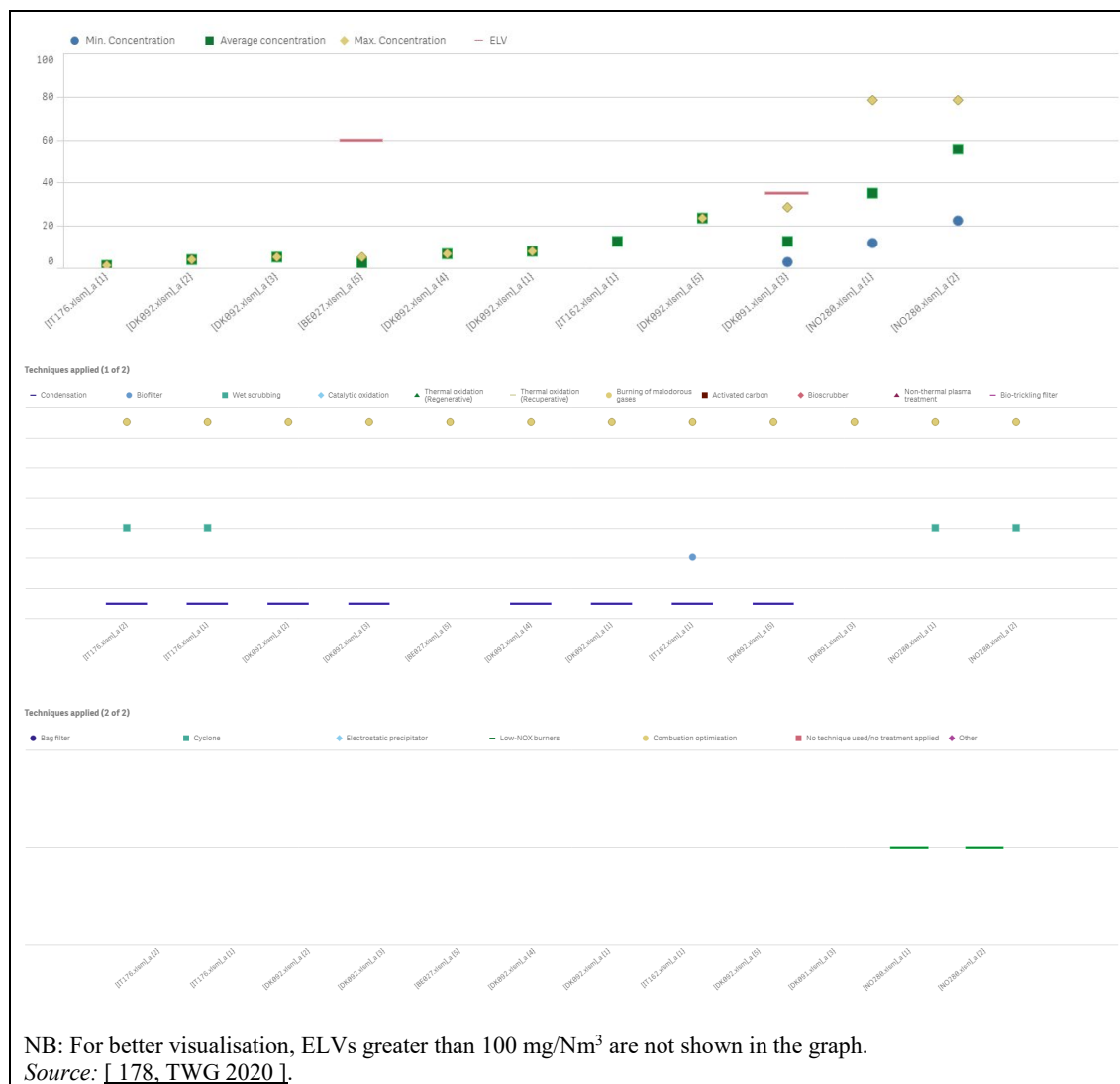

Figure 2.21: SO_x emissions to air (mg/Nm³) from combustion in boilers of malodorous gases, including non-condensable gases, in SA installations (Part 1 of 2)



Figure 2.22: SO_x emissions to air (mg/Nm³) from combustion in boilers of malodorous gases, including non-condensable gases, in SA installations (Part 2 of 2)

Figure 2.23 shows reported data (from installations participating in the data collection, for the years 2016 to 2018) for channelled SO_x emissions to air from combustion in boilers of malodorous gases, including non-condensable gases, in SA installations. Values have been corrected to a reference O₂ level of 3 %.

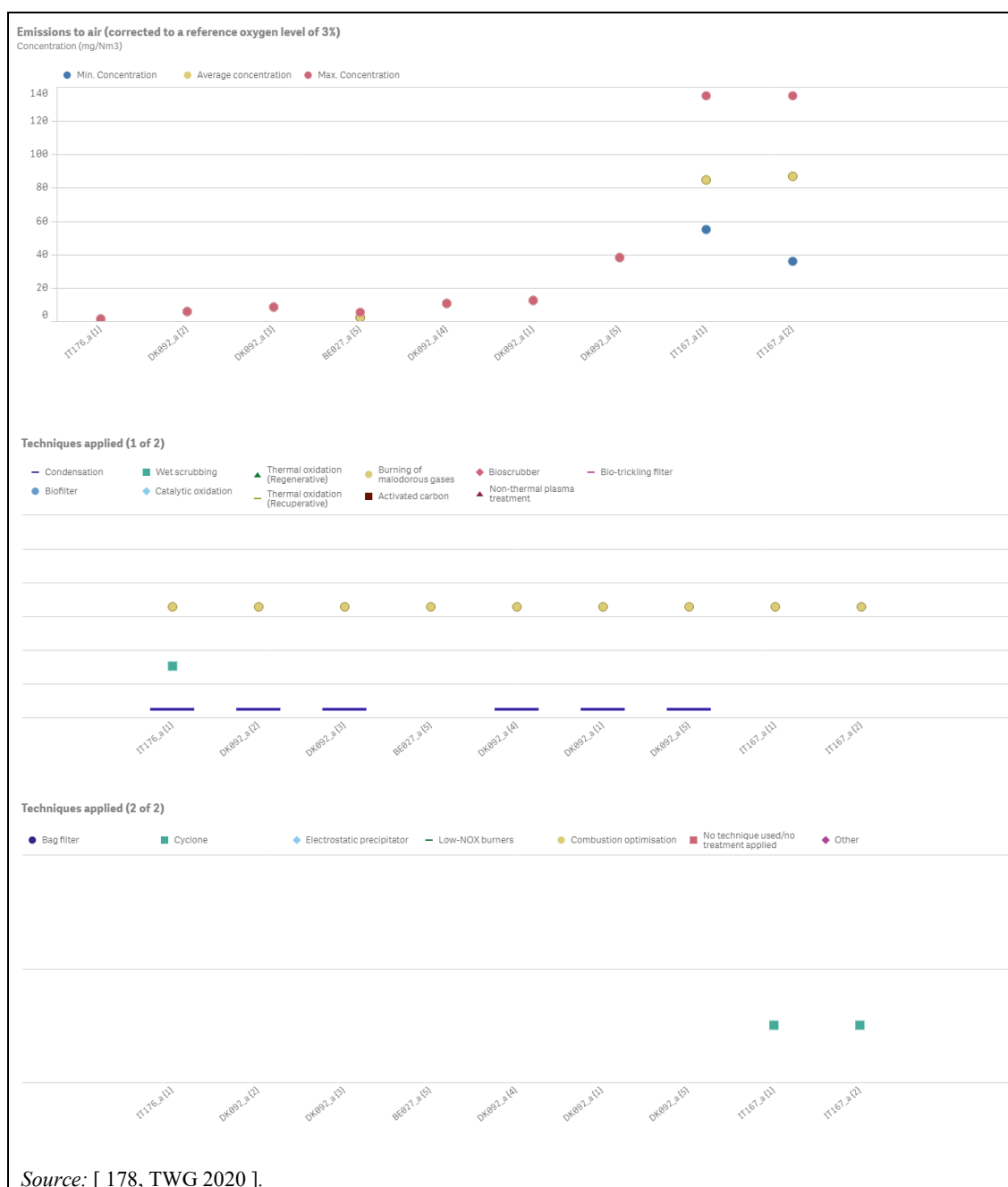

Figure 2.23: SO_x emissions to air (mg/Nm³) from combustion in boilers of malodorous gases, including non-condensable gases, in SA installations (values corrected to 3 % O₂)

Installation IE149 (not shown in the graph) reported average SO_x emission values (at a reference O₂ level of 3 %) from three emission points between 1 069.18 mg/Nm³ and 1 446.17 mg/Nm³.

2.2.2.1.4 CO

Figure 2.24 shows reported data (from installations participating in the data collection, for the years 2016 to 2018) for channelled CO emissions to air from combustion in boilers of malodorous gases, including non-condensable gases, in SA installations. No correction for reported O₂ reference level has been applied.

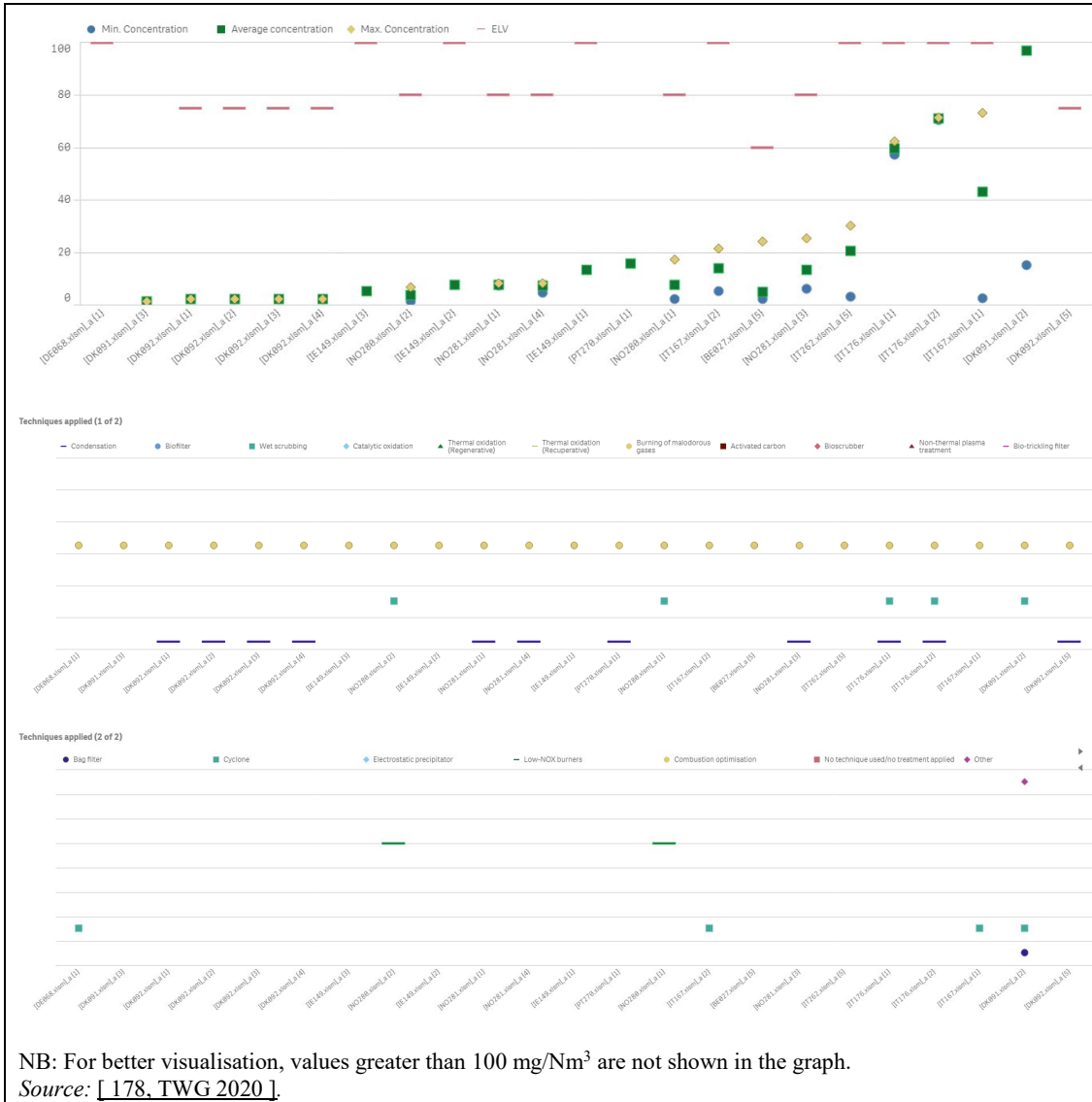

Figure 2.24: CO emissions to air (mg/Nm³) from combustion in boilers of malodorous gases, including non-condensable gases, in SA installations

Figure 2.25 shows reported data (from installations participating in the data collection, for the years 2016 to 2018) for channelled CO emissions to air from combustion in boilers of malodorous gases, including non-condensable gases, in SA installations. Values have been corrected to a reference O₂ level of 3 %.



Figure 2.25: CO emissions to air (mg/Nm³) from combustion in boilers of malodorous gases, including non-condensable gases, in SA installations (values corrected to 3 % O₂)

Installation IE149 (not shown in the graph) reported average CO emission values (at a reference O₂ level of 3 %) from three emission points between 3.07 mg/Nm³ and 24.12 mg/Nm³.

2.2.2.2 Emissions to air from thermal oxidation

2.2.2.2.1 Dust

Figure 2.26 shows reported data (from installations participating in the data collection, for the years 2016 to 2018) for channelled dust emissions to air from thermal oxidation in SA installations. No correction for reported O₂ reference level has been applied. Values have been reported at various O₂ contents.

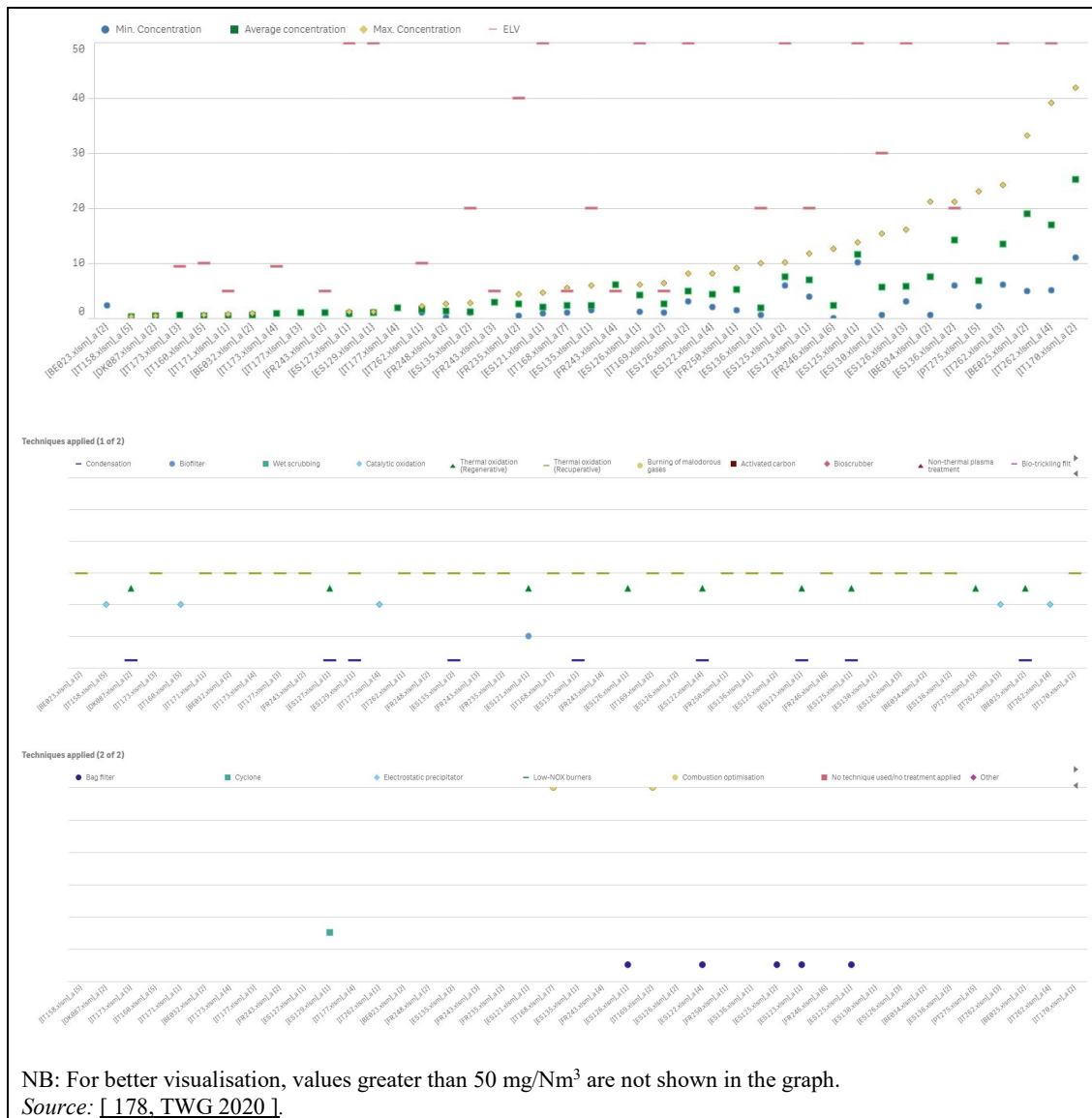

Figure 2.26: Dust emissions to air (mg/Nm³) from thermal oxidation in SA installations

2.2.2.2.2 NO_x

Figure 2.27 and Figure 2.28 show reported data (from installations participating in the data collection, for the years 2016 to 2018) for channelled NO_x emissions to air from thermal oxidation in SA installations. No correction for reported O₂ reference level has been applied. Values have been reported at various O₂ contents.

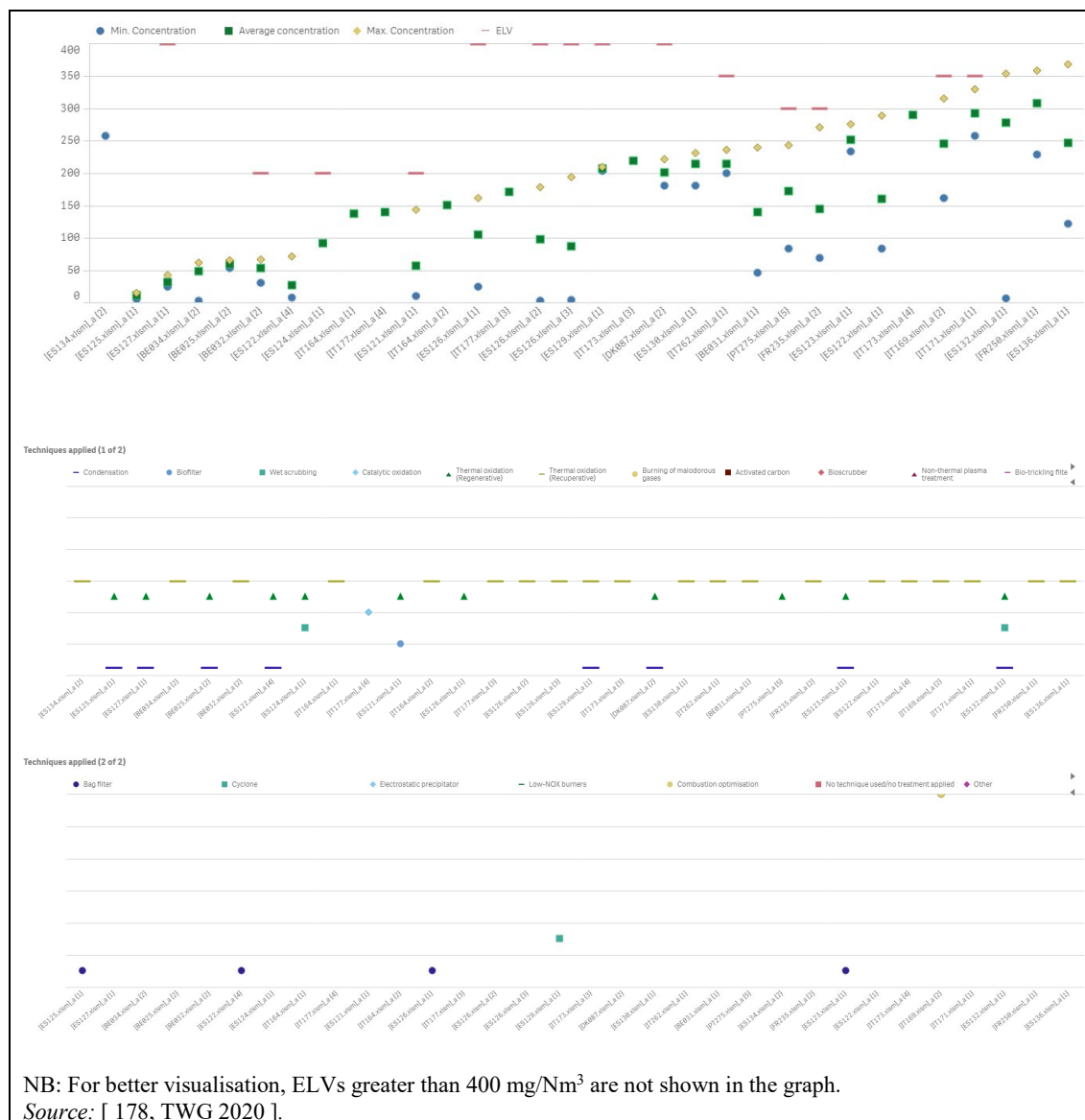
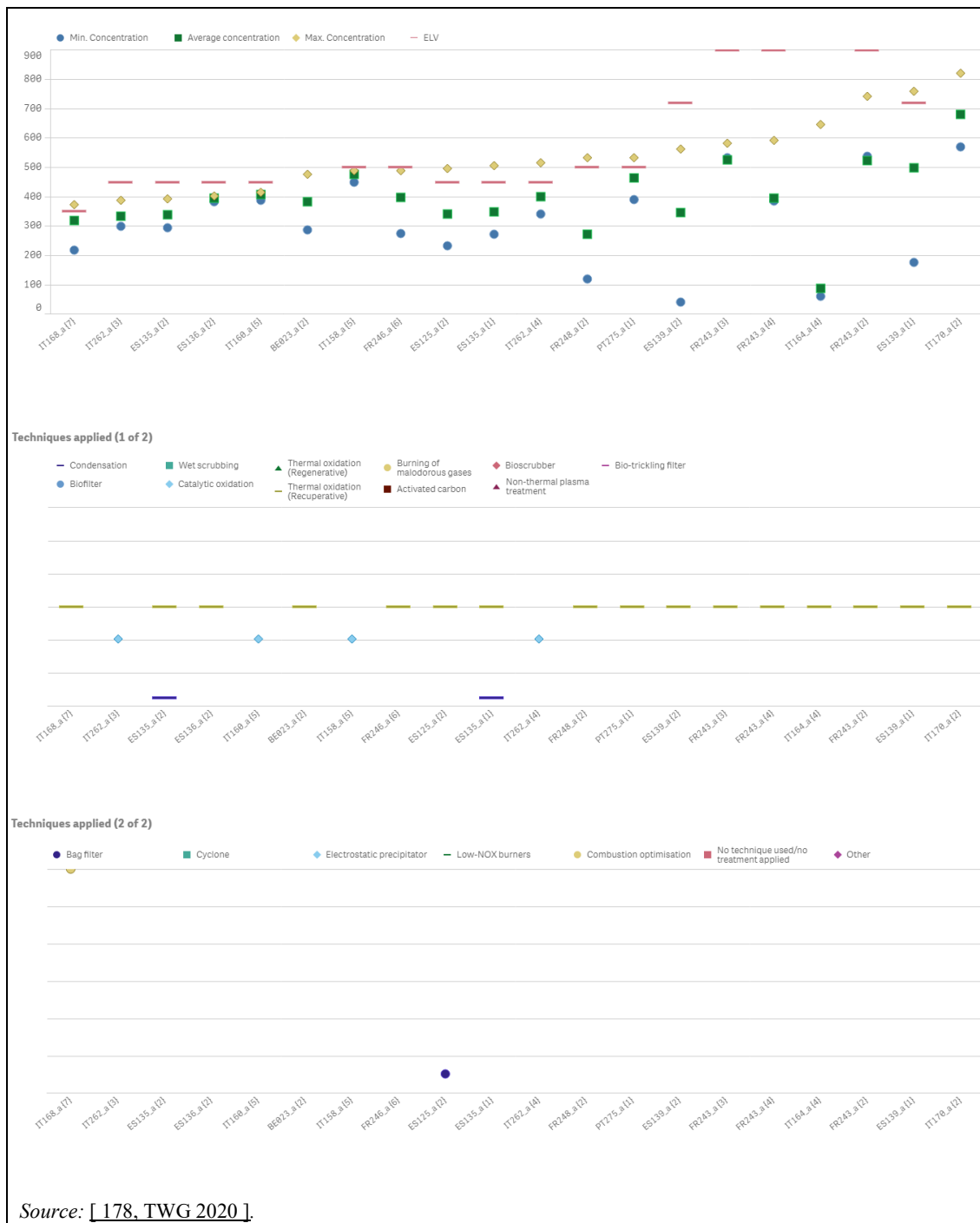

Figure 2.27: NO_x emissions to air (mg/Nm³) from thermal oxidation in SA installations (Part 1 of 2)



Source: [178, TWG 2020].

Figure 2.28: NO_x emissions to air (mg/Nm³) from thermal oxidation in SA installations (Part 2 of 2)

2.2.2.2.3 SO_x

Figure 2.29 and Figure 2.30 show reported data (from installations participating in the data collection, for the years 2016 to 2018) for channelled SO_x emissions to air from thermal oxidation in SA installations. No correction for reported O₂ reference level has been applied. Values have been reported at various O₂ contents.

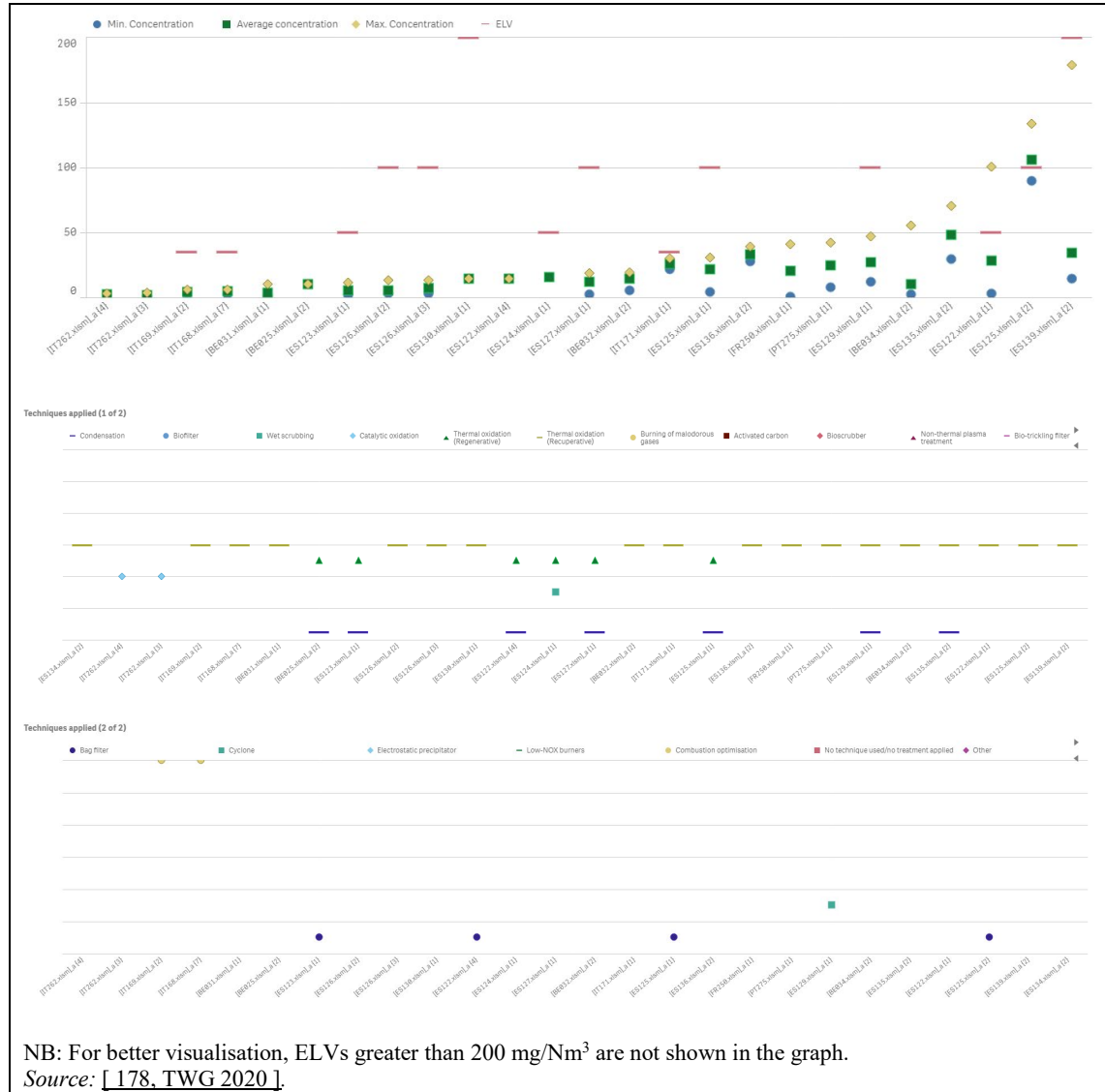

Figure 2.29: SO_x emissions to air (mg/Nm³) from thermal oxidation in SA installations (Part 1 of 2)

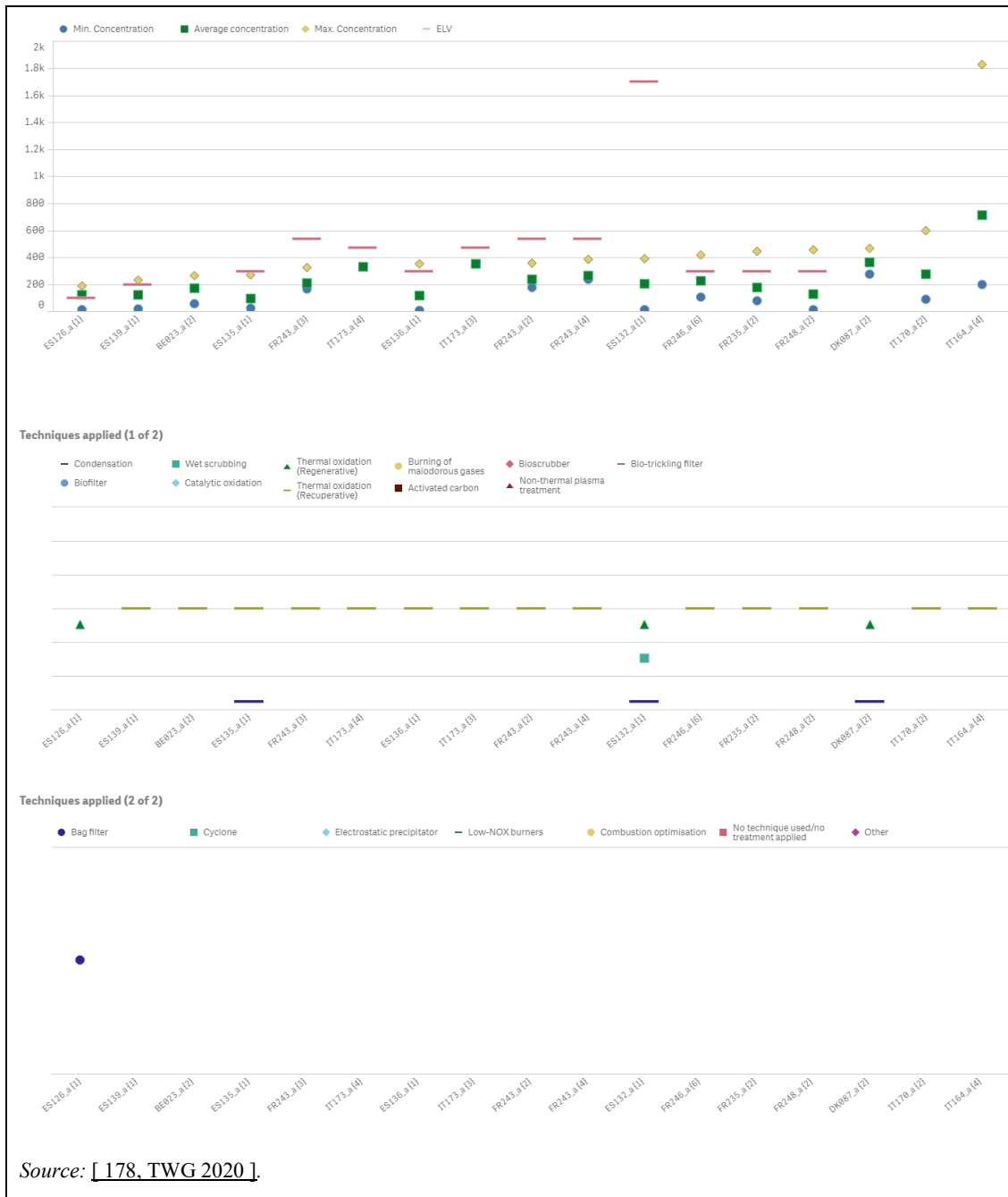

Figure 2.30: SO_x emissions to air (mg/Nm³) from thermal oxidation in SA installations (Part 2 of 2)

2.2.2.2.4 CO

Figure 2.31 shows reported data (from installations participating in the data collection, for the years 2016 to 2018) for channelled CO emissions to air from thermal oxidation in SA installations. No correction for reported O₂ reference level has been applied.

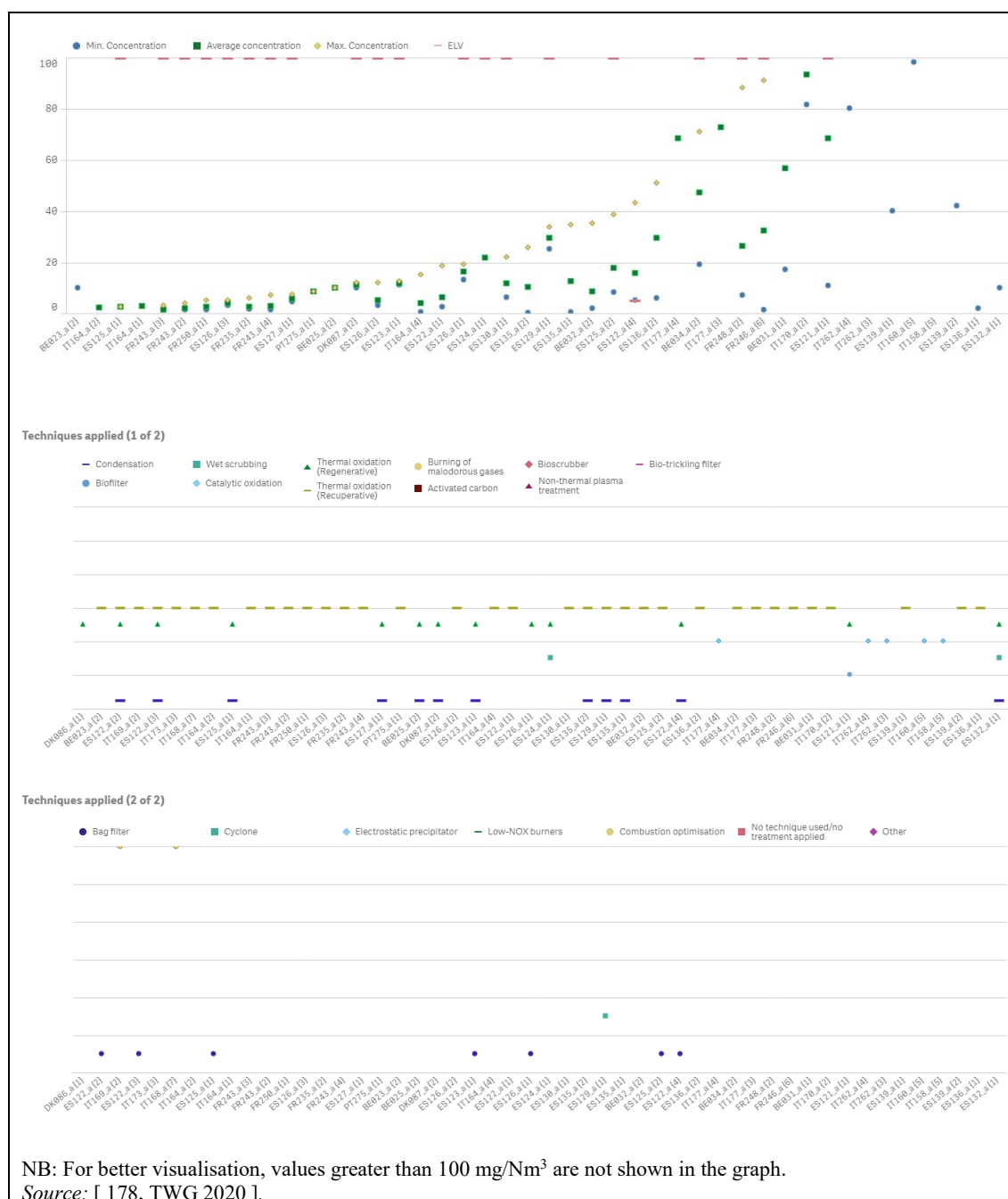
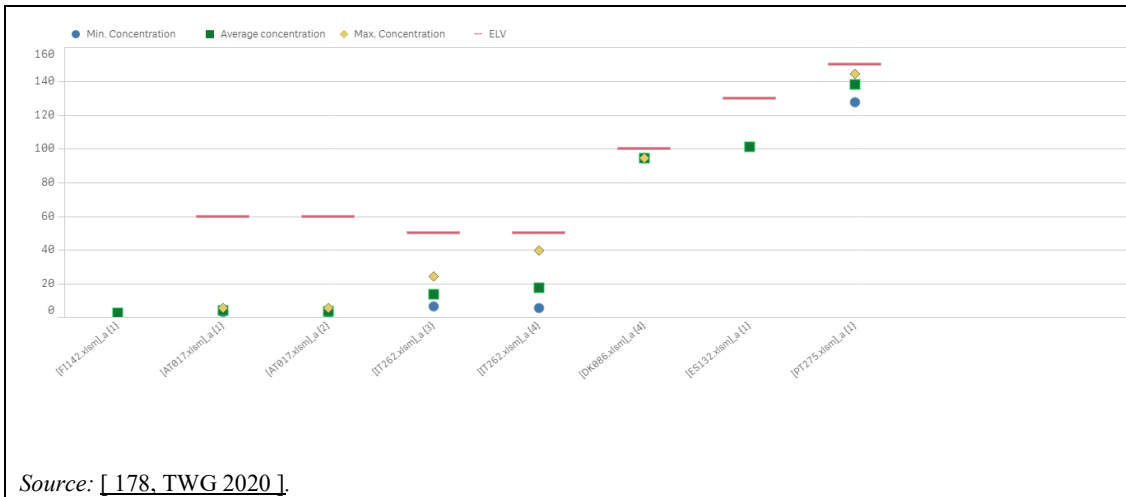

Figure 2.31: CO emissions to air (mg/Nm³) from thermal oxidation in SA installations

2.2.2.3 Emissions to air from combustion of animal fat and meat-and-bone meal (MBM)

2.2.2.3.1 Dust

Figure 2.32 shows reported data (from installations participating in the data collection, for the years 2016 to 2018) for channelled dust emissions to air from combustion of animal fat in SA installations. Very little information has been reported for O₂ reference conditions.



Source: [178, TWG 2020].

Figure 2.32: Dust emissions to air (mg/ Nm³) from combustion of animal fat in SA installations

Data from one emission point for dust emissions to air (with a maximum value of 143.7 mg/Nm³) from combustion of meat-and-bone meal have been reported.

2.2.2.3.2 NO_x

Figure 2.33 shows reported data (from installations participating in the data collection, for the years 2016 to 2018) for channelled dust emissions to air from combustion of animal fat in SA installations. Very little information has been reported for O₂ reference conditions.

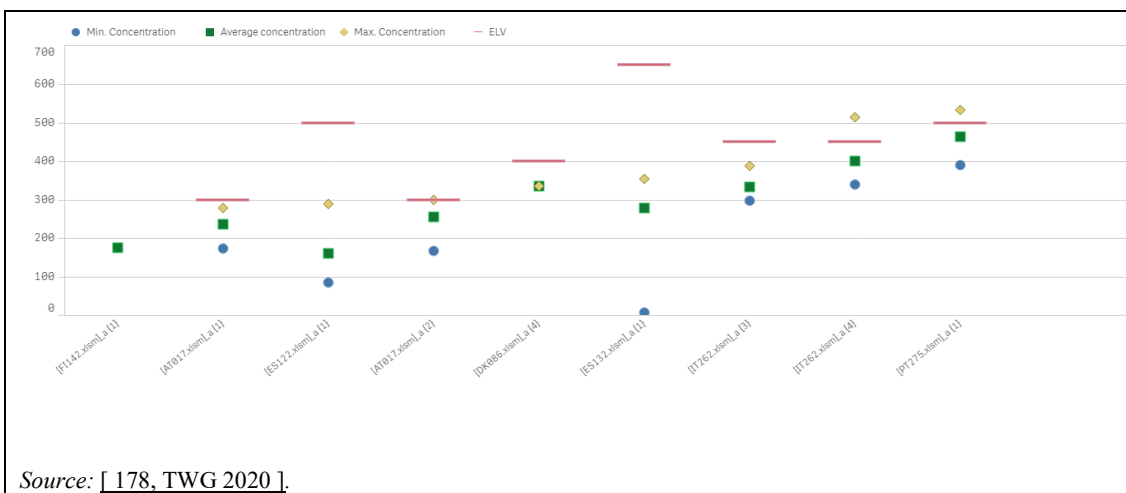

Source: [178, TWG 2020].

Figure 2.33: NO_x emissions to air (mg/Nm³) from combustion of animal fat in SA installations

Data from two emission points for NO_x emissions to air (with an average value of 144.7 mg/Nm³ and a maximum value of 530.4 mg/Nm³ respectively) from combustion of meat-and-bone meal have been reported.

2.2.2.3.3 SO_x

Figure 2.34 shows reported data (from installations participating in the data collection, for the years 2016 to 2018) for channelled dust emissions to air from combustion of animal fat in SA installations. Very little information has been reported for O₂ reference conditions.

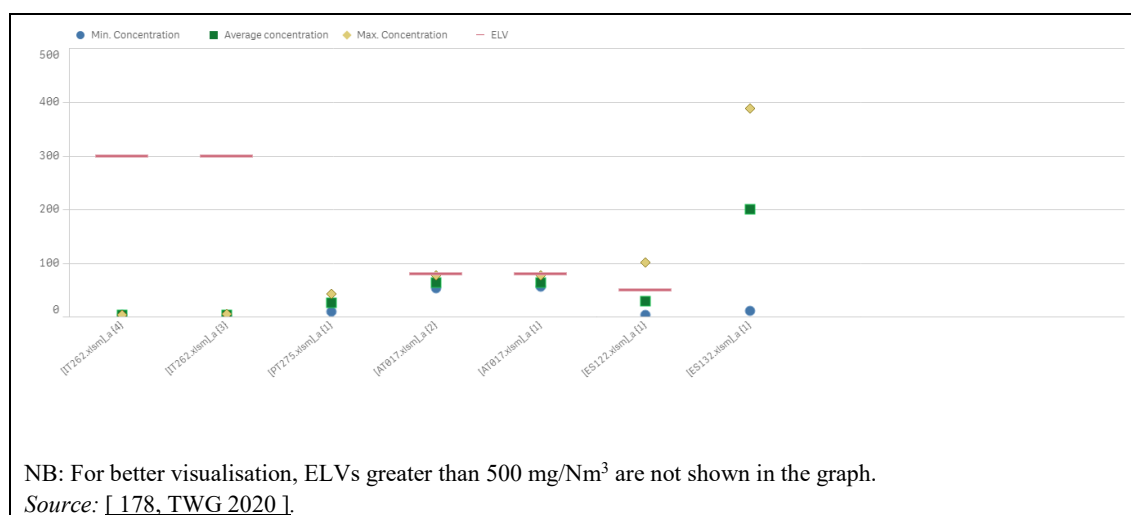

Figure 2.34: SO_x emissions to air (mg/Nm³) from combustion of animal fat in SA installations

Data from one emission point for SO_x emissions to air (with a maximum value of 42 mg/Nm³) from combustion of meat-and-bone meal have been reported.

2.2.2.3.4 CO

Figure 2.35 shows reported data (from installations participating in the data collection, for the years 2016 to 2018) for channelled CO emissions to air from combustion of animal fat in SA installations. Very little information has been reported for O₂ reference conditions.

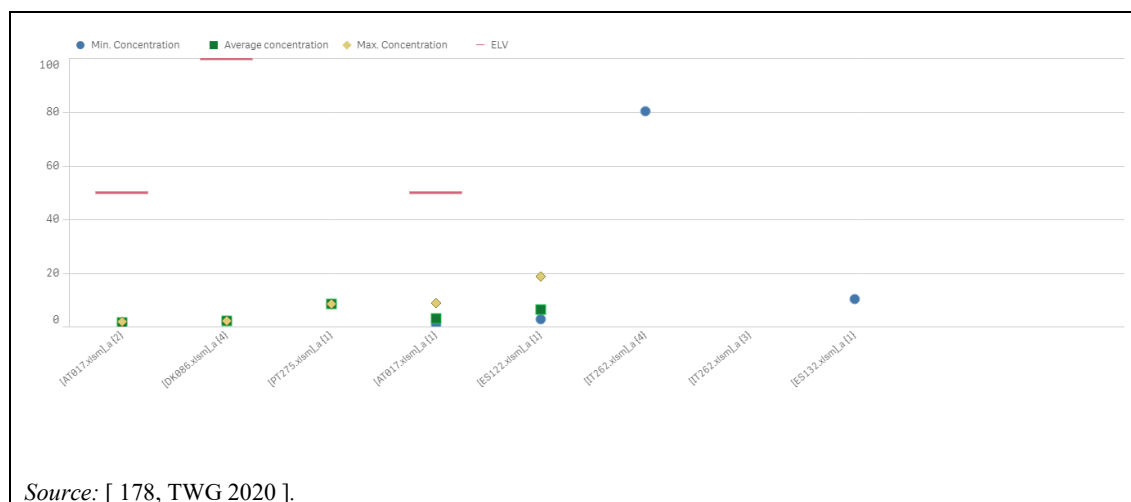

Figure 2.35: CO emissions to air (mg/Nm³) from combustion of animal fat in SA installations

Chapter 2

Data from two emission points for CO emissions to air (with an average value of 15.7 mg/Nm³ and a maximum value of 8.4 mg/Nm³ respectively) from combustion of meat-and-bone meal have been reported.

2.3 Techniques to consider in the determination of BAT across the SA sector

This section describes techniques (or combinations thereof), and associated monitoring, considered to have the potential for achieving a high level of environmental protection in the activities within the scope of this document. The techniques described will include both the technology used and the way in which the installations are designed, built, maintained, operated and decommissioned.

It covers environmental management systems, process-integrated techniques and end-of-pipe measures. Waste prevention and management, including waste minimisation and recycling procedures are also considered, as well as techniques that reduce the consumption of raw materials, water and energy by optimising use and reuse. The techniques described also cover measures used to prevent or to limit the environmental consequences of accidents and incidents, as well as site remediation measures. They also cover measures taken to prevent or reduce emissions under other than normal operating conditions (such as start-up and shutdown operations, leaks, malfunctions, momentary stoppages and the definitive cessation of operations).

Annex III to the IED lists a number of criteria for determining BAT, and the information within this chapter will address these considerations. As far as possible, the standard structure in Table 2.4 is used to outline the information on each technique, to enable a comparison of techniques and the assessment against the definition of BAT in the Directive.

This chapter does not necessarily provide an exhaustive list of techniques which could be applied in the sector. Other techniques may exist, or may be developed, which could be considered in the determination of BAT for an individual installation.

Table 2.4: Information for each technique

Headings within the sections
Description
Technical description
Achieved environmental benefits
Environmental performance and operational data
Cross-media effects
Technical considerations relevant to applicability
Economics
Driving force for implementation
Example plants
Reference literature

2.3.1 General environmental performance

2.3.1.1 Environmental management systems

Description

A formal system to demonstrate compliance with environmental objectives.

Technical description

The Directive defines ‘techniques’ (under the definition of best available techniques) as ‘both the technology used and the way in which the installation is designed, built, maintained, operated and decommissioned’.

In this respect, an environmental management system (EMS) is a technique allowing operators of installations to address environmental issues in a systematic and demonstrable way. EMSs are most effective and efficient where they form an inherent part of the overall management and operation of an installation.

An EMS focuses the attention of the operator on the environmental performance of the installation; in particular through the application of clear operating procedures for both normal and other than normal operating conditions, and by setting out the associated lines of responsibility.

All effective EMSs incorporate the concept of continuous improvement, meaning that environmental management is an ongoing process, not a project which eventually comes to an end. There are various process designs, but most EMSs are based on the plan-do-check-act cycle (which is widely used in other company management contexts). The cycle is an iterative dynamic model, where the completion of one cycle flows into the beginning of the next (see Figure 2.36).

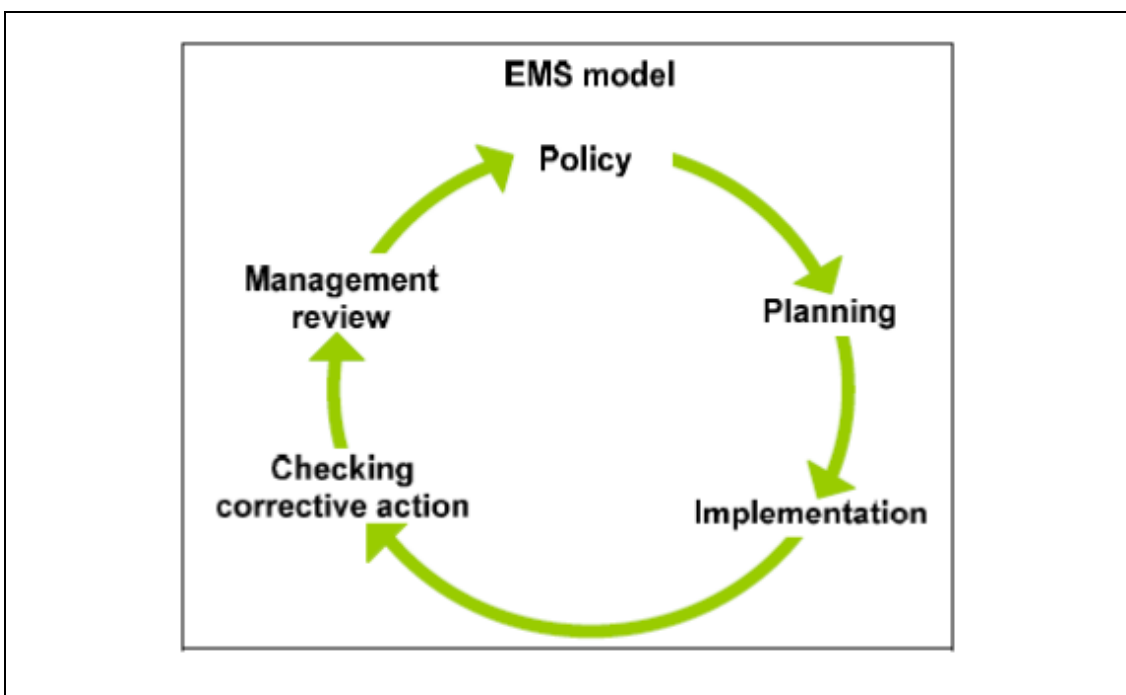

Figure 2.36: Continuous improvement in an EMS model

An EMS can take the form of a standardised or non-standardised (or customised) system. Implementation and adherence to an internationally accepted standardised system, such as EN ISO 14001:2015, can give higher credibility to the EMS especially when subjected to a properly performed external verification. The European Union eco-management and audit scheme (EMAS) according to Regulation (EC) No 1221/2009 provides additional credibility due to the interaction with the public through the environmental statement and the mechanism to ensure compliance with the applicable environmental legislation. However, non-standardised systems can, in principle, be equally effective provided that they are properly designed and implemented.

While both standardised systems (EN ISO 14001:2015 or EMAS) and non-standardised systems apply in principle to organisations, this document takes a narrower approach, not including all activities of an organisation, e.g. with regard to their products and services, due to the fact that the Directive only regulates installations.

An EMS incorporates all of the following features:

- i. commitment, leadership, and accountability of the management, including senior management, for the implementation of an effective EMS;
- ii. an analysis that includes the determination of the organisation's context, the identification of the needs and expectations of interested parties, the identification of characteristics of the installation that are associated with possible risks for the environment (or human health) as well as of the applicable legal requirements relating to the environment;
- iii. development of an environmental policy that includes the continuous improvement of the environmental performance of the installation;
- iv. establishing objectives and performance indicators in relation to significant environmental aspects, including safeguarding compliance with applicable legal requirements;
- v. planning and implementing the necessary procedures and actions (including corrective and preventive actions where needed), to achieve the environmental objectives and avoid environmental risks;
- vi. determination of structures, roles and responsibilities in relation to environmental aspects and objectives and provision of the financial and human resources needed;
- vii. ensuring the necessary competence and awareness of staff whose work may affect the environmental performance of the installation (e.g. by providing information and training);
- viii. internal and external communication;
- ix. fostering employee involvement in good environmental management practices;
- x. establishing and maintaining a management manual and written procedures to control activities with significant environmental impact as well as relevant records;
- xi. effective operational planning and process control;
- xii. implementation of appropriate maintenance programmes;
- xiii. emergency preparedness and response protocols, including the prevention and/or mitigation of the adverse (environmental) impacts of emergency situations;
- xiv. when (re)designing a (new) installation or a part thereof, consideration of its environmental impacts throughout its life, which includes construction, maintenance, operation and decommissioning;
- xv. implementation of a monitoring and measurement programme, if necessary, information can be found in the Reference Report on Monitoring of Emissions to Air and Water from IED Installations;
- xvi. application of sectoral benchmarking on a regular basis;
- xvii. periodic independent (as far as practicable) internal auditing and periodic independent external auditing in order to assess the environmental performance and to determine whether or not the EMS conforms to planned arrangements and has been properly implemented and maintained;
- xviii. evaluation of causes of nonconformities, implementation of corrective actions in response to nonconformities, review of the effectiveness of corrective actions, and determination of whether similar nonconformities exist or could potentially occur;
- xix. periodic review, by senior management, of the EMS and its continuing suitability, adequacy and effectiveness;
- xx. following and taking into account the development of cleaner techniques.

Specifically for slaughterhouses as well as the processing of animal by-products and/or edible co-products, it is also important to incorporate the following potential features in the EMS:

- xxi. an odour management plan;
- xxii. an inventory of inputs and outputs;
- xxiii. a chemicals management system;
- xxiv. an energy efficiency plan;
- xxv. a water management plan;
- xxvi. a noise management plan;
- xxvii. an OTNOC management plan;
- xxviii. a refrigeration management plan for slaughterhouses.

Achieved environmental benefits

An EMS promotes and supports the continuous improvement of the environmental performance of the installation. If the installation already has a good overall environmental performance, an EMS helps the operator to maintain the high performance level.

Environmental performance and operational data

No information provided.

Cross-media effects

None reported. The systematic analysis of the initial environmental impacts and scope for improvements in the context of the EMS sets the basis for assessing the best solutions for all environmental media.

Technical considerations relevant to applicability

The components described above can typically be applied to all installations within the scope of this document. The level of detail and the degree of formalisation of the EMS will generally be related to the nature, scale and complexity of the installation, and the range of environmental impacts it may have.

Economics

It is difficult to determine accurately the costs and economic benefits of introducing and maintaining a good EMS. There are also economic benefits that are the result of using an EMS and these vary widely from sector to sector.

External costs relating to verification of the system can be estimated from guidance issued by the International Accreditation Forum [200, IAF 2010].

Driving force for implementation

The driving forces for the implementation of an EMS include:

- improved environmental performance;
- improved insight into the environmental aspects of the company which can be used to fulfil the environmental requirements of customers, regulatory authorities, banks, insurance companies or other stakeholders (e.g. people living or working in the vicinity of the installation);
- improved basis for decision-making;
- improved motivation of personnel (e.g. managers can have confidence that environmental impacts are controlled and employees can feel that they are working for an environmentally responsible company);
- additional opportunities for operational cost reduction and product quality improvement;
- improved company image;
- reduced liability, insurance and non-compliance costs.

Example plants

EMSs are applied in a high number of installations throughout the EU [201, COM 2021].

Reference literature

[200, IAF 2010], [202, COM 2009], [201, COM 2021].

2.3.1.2 Use of a planned maintenance programme

Description

A maintenance programme is part of the environmental management system of the installation (see Section 2.3.1.1).

Technical description

The use of a planned maintenance programme, which involves changing parts and routinely checking the function of equipment can significantly reduce consumption and emission levels. This can involve the appointment of a competent individual with responsibility for managing maintenance in co-operation with operational managers. The maintenance manager's performance can also be monitored. Records of inspections, plans, permits and other relevant information can be used to monitor improvements and anticipate required actions, such as the replacement of parts.

Achieved environmental benefits

Reduced consumption and emission levels and reduced risks of accidents throughout the plant.

Environmental performance and operational data

Maintaining up-to-date plans of slaughterhouse drainage systems can aid the maintenance and operation of the applied waste water treatment. Management needs to ensure that there are regular inspection programmes put in place to assess tank bunding, underground tanks and drain integrity and aboveground pipework. Surface water drains located next to skips containing SRM and other animal wastes can be connected to the effluent drainage system. A leak detection and repair programme can be used to save hot and cold water. Some examples of common causes of leaks include damaged pipeline connections; flanges and fittings; worn valves; flooded floats on water tanks, cistern valves and corroded pipework and tanks.

Cross-media effects

None.

Technical considerations relevant to applicability

Applicable in all SA installations.

Driving force for implementation

Reduced downtime due to breakdowns and accidents. Routinely considering the environmental impacts can help to focus the efforts to achieve lower consumption and emission levels, leading to cost savings and increasing the confidence of the regulatory authority.

Example plants

At least one poultry slaughterhouse in the UK.

Reference literature

[4, WS Atkins-EA 2000], [11, ETBPP 2000], [13, WS Atkins-EA 2000], [31, Greek Ministry for the Environment 2001], [49, AVEC 2001].

2.3.1.3 Chemicals management system**Description**

The chemicals management system is part of the EMS (see Section 2.3.1.1) and is a set of technical and organisational measures to limit the impact of the use of chemicals on the environment.

Technical description

The chemicals management system (CMS) incorporates all of the following features:

- I. A policy to reduce the consumption and risks associated with chemicals, including a procurement policy to select less harmful chemicals and their suppliers with the aim of minimising the use and risks associated with hazardous substances and substances of very high concern and avoiding the procurement of an excess amount of chemicals. The selection of chemicals is based on:

- a) the comparative analysis of their bioeliminability/biodegradability, eco-toxicity and potential to be released into the environment in order to reduce emissions to the environment;
- b) the characterisation of the risks associated with the chemicals, based on the chemicals' hazard classification, pathways through the plant, potential release and level of exposure;
- c) the regular (e.g. annual) analysis of the potential for substitution to identify potentially new available and safer alternatives to the use of hazardous substances and substances of very high concern (e.g. use of other chemicals with no or lower impacts on the environment and/or human health);
- d) the anticipatory monitoring of regulatory changes related to hazardous substances and substances of very high concern and the safeguarding of compliance with applicable legal requirements.

The inventory of process chemicals may be used to provide and keep the information needed for the selection of chemicals.

- II. Goals and action plans to avoid or reduce the use and risks associated with hazardous substances and substances of very high concern.
- III. Development and implementation of procedures for the procurement, handling, storage and use of chemicals to prevent or reduce emissions to the environment.

Achieved environmental benefits

Reduction of the use of hazardous chemicals.

Environmental performance and operational data

No information provided.

Cross-media effects

None.

Technical considerations relevant to applicability

The level of detail and the degree of formalisation of the CMS will generally be related to the nature, scale and complexity of the plant.

Economics

No information provided.

Driving force for implementation

The driving forces for the implementation of a CMS include:

- improved environmental performance;
- compliance with regulations and/or certification schemes;
- optimised consumption of hazardous chemicals.

Example plants

No information provided.

Reference literature

[161, Roth et al. 2023].

2.3.1.4 Set-up and implementation of an OTNOC management plan to reduce emissions during OTNOC

Description

A risk-based OTNOC management plan includes all of the following elements:

- i. identification of potential OTNOC (e.g. failure of equipment critical to the protection of the environment ('critical equipment')), of their root causes and of their potential consequences;
- ii. appropriate design of critical equipment (e.g. waste water treatment plant);
- iii. set-up and implementation of an inspection plan and preventive maintenance programme for critical equipment;
- iv. monitoring (i.e. estimating or, where possible, measuring) and recording of emissions during OTNOC and of associated circumstances;
- v. periodic assessment of the emissions occurring during OTNOC (e.g. frequency of events, duration, amount of pollutants emitted) and implementation of corrective actions if necessary;
- vi. regular review and update of the list of identified OTNOC under point i. following the periodic assessment of point v.;
- vii. regular testing of backup systems.

Technical description

When applying the processes described above, the SA plant may experience other than normal operating conditions (OTNOC). These OTNOC are very diverse and may cover conditions such as:

- start-up;
- shutdown;
- momentary stoppages;
- leaks (e.g. liquid or gaseous substances);
- malfunction or breakdown of the abatement equipment or part of the equipment (e.g. biofilters);
- malfunction of instruments related to the process control or used for emission monitoring (such as instrumentation drift);
- testing of new apparatus;
- calibration of the monitoring system.

In order to reduce the frequency of the occurrence of OTNOC and to reduce emissions during OTNOC, a risk-based OTNOC management plan as part of the environmental management system (see Section 2.3.1.1) is put in place and may include the elements described in the description section above.

Achieved environmental benefits

Reduced emissions to air and/or water.

Environmental performance and operational data

Malfunctions in a waste gas treatment plant can result in a significant increase in emissions (e.g. dust). To prevent this, the following measures are put in place:

Preventive maintenance

Preventive maintenance is used to:

- ensure that maintenance requiring switching off emissions control equipment/systems (e.g. containment, extraction systems, off-gas treatment) is planned to take place when there are no emissions (e.g. shutdown times) or when emission levels are low;
- replacement of parts that require replacement on a regular basis is planned to take place before breakdowns are likely;
- ensure that parts that are essential to the normal running of emission control equipment are kept in stock, can be replaced or repaired rapidly with minimum call-off times;
- carry out routine and non-routine maintenance including maintenance of covers and pipe joints for oil/acid storage and delivery systems.

Regular maintenance checks

A maintenance schedule and record of all inspections and maintenance activities is kept and includes the following:

- visually check for leaking seals, flanges, valves, welds, tanks and vats;
- inspections by external experts where necessary;
- monitoring key equipment for problems such as vibration, emission leaks and planning repairs (as above);
- test programmes, e.g. pressure-test pipelines and tanks, calibration of metering and monitoring equipment;
- check the tightness of nuts and bolts;
- check for wear and tear on machinery, valves and bunds, over-heating bearings, etc.;
- recalibrate metering systems;
- ensure that extraction and abatement equipment is fully serviceable.

Unplanned maintenance

Process operators and maintenance staff identify and report leaks, broken equipment, fractured pipes, etc.

Cross-media effects

None.

Technical considerations relevant to applicability

Generally, there are no technical restrictions to the applicability of this technique. The level of detail and degree of formalisation of the OTNOC management plan will generally be related to the nature, scale and complexity of the installation, and the range of environmental impacts it may have.

Economics

Avoiding plant shutdowns can reduce costs at SA installations by allowing continuous throughput and hence greater installation utilisation.

Driving force for implementation

- Reduces downtime.
- Maintains product quality and throughput.

Example plants

Occasionally used in the SA sector [211, TWG 2023].

Reference literature

[120, Aries et al. 2022], [211, TWG 2023].

2.3.2 Techniques to increase resource efficiency

2.3.2.1 Anaerobic digestion

Description

Treatment of biodegradable residues by microorganisms in the absence of oxygen, resulting in the generation of biogas and digestate. The biogas is used as a fuel, e.g. in a gas engine or in a boiler. The digestate may be used as a fertilising product.

Technical description

The treatment of biodegradable solids by anaerobic digestion is used to transform the organic matter contained in the residues into biogas (containing around 70 % methane) and digestate.

Anaerobic digestion is used to handle biodegradable solids very high in COD, and as a treatment process for sewage sludge after an aerobic waste water treatment.

The technique generally consists of the following steps:

- Anaerobic digestion: residues are directed to a sealed digester tank where anaerobic digestion takes place. This is a process by which microorganisms break down biodegradable material in the absence of oxygen, resulting in biogas and digestate.
- Biogas line: generated biogas is stored and at a later stage is dehumidified and used, e.g. in a cogenerator. It can also be used to produce heat, i.e. hot water in a boiler, combined electricity and heat in a CHP unit, as an alternative fuel in vehicles or as a substitute for natural gas after upgrading to biomethane. Some of the heat generated may be recycled in the SA process.
- Separation: the digestate is separated into solid and liquid fractions by centrifugation.
- Storage of the solid fraction of the digestate: the solid fraction of the digestate is stored for agricultural purposes (landspreading).

More detailed information on the process description, feed and output streams, biogas pretreatment techniques, and characteristics of the digestate is available in the WT BREF [179, Pinasseau et al. 2018]. A list of proven improvement techniques for anaerobic digestion of waste (e.g. micro-anaerobic digestion, vertical flow dry) is described in the EC report 'Towards a better exploitation of the technical potential of waste to energy' [192, COM 2016].

Anaerobic co-digestion allows the operator to take advantage of the complementary nature of the different components of the waste. The mixture of both types of waste leads to more stable processes and a considerable increase in biogas production. The co-digestion allows the integration of the exploitation of organic waste in a given geographical area. Anaerobic digestion systems commonly used for the co-digestion of agro-industrial waste are called continuous stirred tank reactors.

Achieved environmental benefits

Waste generation and emissions to air are reduced (biogas is used for energy to replace fossil fuels). The recovery of by-products to produce digestate for agriculture conserves and recycles nutrients and reduces waste discharge and the use of chemical fertiliser.

Environmental performance and operational data

A biogas plant in a pig slaughterhouse in Austria is predominantly operated by fermenting accruing animal by-products (e.g. colon (large intestine)), and flotated fat and solids screened from the WWTP [113, Waxwender et al. 2016].

Anaerobic digestion of approximately 80 m³/d of sludge with a dry mass content of approximately 9 % produces roughly 5 000 m³/d of biogas [181, VDI 2020].

Biogas generated from digestion of WWTP sludge is used for the production of steam and hot water in a pig slaughterhouse (ES119). This allows for a reduction of 17 % in the consumption of natural gas and a reduction of 9 000 tonnes of CO₂/year [178, TWG 2020].

Emissions to water from anaerobic digestion in SA installations are not an environmental issue, given that the digestate is usually treated in the WWTP.

Cross-media effects

The nitrogen content of residues is not reduced after anaerobic digestion. Further waste water treatment of liquid digestate is usually required (e.g. membrane filtration).

Technical considerations relevant to applicability

The technique may not be applicable due to the quantity and/or nature of the residues. Digesters should be fed at a constant rate to operate properly. Due to the investment costs, a digester may not be applicable to installations with low amounts of residues.

Economics

An investment cost of EUR 3 500 000 has been reported, including an anaerobic biodigester plant, biogas cogenerator, centrifuge and a scrubber as the abatement system. The amount of electricity produced by the biogas cogenerator in a 6-month period was approximately 40 000 MWe. The amount of solid fraction of the digestate produced is about 3 500 tonnes/year. Savings of EUR 50 000/year have been reported due to the reduction of sludge considered as waste.

Driving force for implementation

Economic reasons are the main drivers for implementation, due to reduced energy consumption and waste generation.

Example plants

This technique is used in approximately 50 % of the slaughterhouses and in a few installations processing animal by-products and/or edible co-products [178, TWG 2020]. In some cases (e.g. some slaughterhouses in Denmark), anaerobic digestion takes place off site [204, TWG 2021].

Reference literature

[113, Waxwender et al. 2016], [121, Giner-Santonja et al. 2019], [179, Pinasseau et al. 2018], [192, COM 2016], [178, TWG 2020], [181, VDI 2020].

2.3.2.2 Residues separation and recycling/recovery

Description

Separation of residues, e.g. using accurately positioned screens, flaps, catchpots, drip trays and troughs, for recycling and recovery.

Technical description

Outputs can be separated for optimised and easier use, reuse, recovery and recycling. This also reduces both the consumption and the contamination of water. It can be done either manually or mechanically. These outputs may include rejected raw materials, trimmings and off-specification products.

Accurately positioned, screens, flaps, drip trays and troughs can be used to contain individual materials separately. They can be fitted at processing, filling/packing and transfer lines and next to workstations, such as peeling, cutting and trimming benches. The position and design of a tray or trough for example, the means of preventing mixing with water and the transportation of the liquids or solids depend on the unit operation, the degree of segregation of different materials desired or required and their ultimate intended use, or disposal route.

A catchpot is a fine mesh basket placed over floor drains, to prevent solids from entering the drainage system and the WWTP. Catchpots can be locked in place to ensure that solids are not able to enter the WWTP during cleaning. If they are emptied after dry cleaning and locked in place again before wet cleaning, then entrainment of soluble materials and of particles can be avoided.

Examples of materials which can be collected and transported dry include bones and fat from deboning and trimming meat. These may or may not be intended for human consumption.

Achieved environmental benefits

Reduced entrainment of solids in waste water and consequently reduced COD, BOD and TSS loadings at the WWTP.

Environmental performance and operational data

In many slaughterhouses and animal by-products installations, it is common practice for staff involved in clean-up operations to remove floor drain grates and flush solid materials, such as offcuts and meat scraps, directly down the drain. This may be done without thought, or in the belief that a subsequent screen or catchpot will trap all solids.

To reduce effluent loading, efforts can be made to keep the solids out of the waste water stream in the first place. For example, carcass dressing can be examined carefully for opportunities to intercept solid materials before they enter the drains. Similarly, cleaning staff can be encouraged to empty drain catchpots into a waste bin and replace them at the drainage point before using water to clean an area. This has the additional advantage that the solids are collected dry, so they both weigh less and are hence cheaper to transport and so that energy is not required to remove excess water.

Cross-media effects

Potential generation of odour if separated solids are not periodically collected and sent to their subsequent destination.

Technical considerations relevant to applicability

Applicable in all SA installations.

Economics

Inexpensive.

Driving force for implementation

Reduced load at the WWTP, associated cost savings and ABP Regulation (Regulation (EC) No 1069/2009).

Example plants

Most slaughterhouses and animal by-products installations have drains with screens or traps fitted.

Reference literature

[4, WS Atkins-EA 2000], [31, Greek Ministry for the Environment 2001], [121, Giner-Santonja et al. 2019].

2.3.2.3 Overfilling protection on bulk storage tanks, e.g. containing blood**Description**

Level detection devices are implemented, which automatically detect the level of liquid in a vessel and send an audible and visual signal.

Technical description

Level detection devices can be fitted, which will automatically detect the level of liquid in a vessel and send an audible and visual signal, first to warn that the capacity is close to full and then, if no action is taken, to actually stop the tank from filling, e.g. by stopping the pump or diverting the flow.

Achieved environmental benefits

Reduced risk of accidental overfilling, which could otherwise lead, e.g. in the case of blood, to a massive increase in the COD of the waste water and a potential disabling of the on-site or

municipal WWTP, or if the yard water soaks away without treatment, to potential major pollution of local watercourses.

Environmental performance and operational data

Overfilling protection may automatically cut off the supply of further liquids, or it could comprise a system of audible and visual alarms, to which operators respond. The choice generally depends on the hazard associated with the substance being stored. Where the substance is hazardous to the environment and/or to personnel, automated systems are generally provided and maintained. This reduces the element of risk associated with human error.

For example, the spillage of blood is potentially one of the most environmentally harmful accidents that can happen in a slaughterhouse. The blood may escape to local watercourses or cause problems in an on-site WWTP, due to shock loading. The risk of this can be reduced by installing a high level alarm on the blood tank, linked to an automatic cut-off device for the blood trough pumps. For example, a mechanism using a ballcock can be used. The ballcock hits an electrical switch which then operates a solenoid and activates a valve, which prevents further filling.

Cross-media effects

None reported.

Technical considerations relevant to applicability

Applicable in all SA installations where bulk liquids are stored, which, if released to the environment, could cause significant pollution.

Economics

Inexpensive.

Driving force for implementation

Prevention of the accidental release of liquids hazardous to the environment.

Example plants

Overfilling protection on bulk storage tanks is in widespread use throughout the chemical industry and in industries where liquids that are hazardous to the environment, including to humans, are used, e.g. in the process or for cleaning.

Reference literature

[26, Finnish Environment Institute and Finnish Food and Drink Industries' Federation 2001], [2, EPA 1996], [62, Germany 2002], [83, Durkan J. 2002], [87, HSE 1998].

2.3.2.4 Bunding of bulk storage tanks, e.g. containing blood

Description

A bund wall capable of holding at least 110 % of the volume of the largest storage tank within it and of adequate strength and integrity to contain the liquid stored is provided.

Technical description

A bund wall capable of holding at least 110 % of the volume of the largest storage tank within it and of adequate strength and integrity to contain the liquid stored can be provided. This is normally considered to be sufficient to contain the contents in the event of a catastrophic failure. A smaller capacity bund may be provided if the liquid can be directed to a separate collection area. In this case diversion walls with a minimum height of 0.5 metres can prevent the bund from overfilling.

Achieved environmental benefits

Reduced risk of accidental leakage and spillage, which could otherwise lead, e.g. in the case of blood, to a massive increase in the COD of the waste water and potential disabling of the on-site or municipal WWTP, or if the yard water soaks away without treatment, overfilling could lead to potential major pollution of local watercourses and land.

Environmental performance and operational data

A bund wall should incorporate a method of removing rainwater and the need for this should be assessed regularly and in particular always after rainfall. Rainwater should be removed to ensure that the capacity of the bund is always sufficient to contain the contents of the tank, if it is required to do so. The integrity of the bund should be checked on a regular basis.

If bund walls exceed 0.6 metres in height, particular attention may be required to ensure their strength and a fixed means of escape may be required. Bund walls are usually positioned at least 1 metre away from a tank with a capacity of up to 100 m³ and 2 metres for larger tanks. Damage to bunds can be prevented by impact protection, such as crash barriers or bollards and by good traffic management.

Cross-media effects

None reported.

Technical considerations relevant to applicability

Applicable in all SA installations where bulk liquids are stored, which if released to the environment could cause significant pollution.

Economics

No information provided.

Driving force for implementation

To prevent the accidental release of liquids hazardous to the environment.

Example plants

Provision of bunding of bulk storage tanks is in widespread use throughout the chemical industry and in industries where liquids hazardous to the environment are used for cleaning.

Reference literature

[2, EPA 1996], [87, HSE 1998].

2.3.2.5 Double skin protection of bulk storage tanks, e.g. containing blood**Description**

A double skinned wall is implemented on bulk storage tanks.

Technical description

A double skinned wall on bulk storage tanks provides some protection against a release of liquids through corrosion, wear or catastrophic damage.

Achieved environmental benefits

Reduced risk of accidental leakage and spillage, which could otherwise lead, e.g. in the case of blood, to a massive increase in the COD of the waste water and potential disabling of the on-site or municipal WWTP, or if the yard water soaks away without treatment, overfilling could lead to potential major pollution of local watercourses. A small degree of insulation from heat may be achieved, which may to a small extent reduce the rate of fermentation of blood and thereby slow down the formation of malodorous gases.

Environmental performance and operational data

Internal failures might remain undetected, so periodic inspections should be scheduled and undertaken. The monitoring system can use either vacuum or pressure to provide an alarm if one of the skins fails.

Cross-media effects

None.

Technical considerations relevant to applicability

Applicable in all SA installations where bulk liquids are stored, which if released to the environment could cause significant pollution.

Economics

No information provided.

Driving force for implementation

Reduced risk of spillage.

Example plants

Provision of double-skinned blood tanks is common practice.

Reference literature

[87, HSE 1998].

2.3.2.6 Minimisation of biological degradation of animal by-products and/or edible co-products

See also Section 2.3.8.2.7 for further information about the storage of blood and Section 3.3.3.2.1 for information about the storage of hides/skins.

Description

Animal by-products and/or edible co-products are promptly collected in slaughterhouses and are stored in closed vessels or rooms in SA installations, for as short a time as possible, before further treatment. Raw materials intended for human consumption (e.g. fat, blood), feed material or pet food may require refrigeration.

Technical description

By-products destined for use or disposal can be stored in closed vessels or rooms in SA installations, for as short a time as possible, before further treatment. Depending on the nature of the by-products, such as their inherent odour characteristics and how rapidly they biodegrade and create an odour nuisance, it may be prudent to also refrigerate them, particularly during warm weather and in hot climates.

Raw materials intended for human consumption (e.g. fat, blood) may also require refrigeration. Cooling can take place, if necessary, at the slaughterhouse, in transit or at the animal by-products installation. This applies at both the slaughterhouse and the animal by-products installation. Although the IED does not apply to the transport of materials between installations, by implication it is good practice to control the conditions of transport as these may have a very significant influence on odour emissions for example at the by-products installation. Moreover, when transferring fluent and odorous by-products or waste (e.g. blood, wet manure) from storage tanks to vessels, it is also good practice to ensure that the air, which is displaced from the vessel tank when filling it, is transferred back into the storage tank or to abatement equipment in order to prevent odour emissions.

Commission Regulation (EU) No 142/2011 contains some requirements for temperature conditions for the collection and transportation of animal by-products 'in sealed new packaging

or covered leak-proof containers or vehicles' and for 'the maintenance of an appropriate temperature throughout transport'. The cooling/cold storage of Category 3 materials destined for the production of feed material or pet food is not mandatory at slaughterhouse level if these are collected and processed within 24 hours (see also Section 4.3.2.2) [156, TWG 2019].

If raw materials are handled as fresh as possible, the quantity of compounds that end up in the waste water or the air can be reduced. For example, by cooling warm waste, such as soft waste from the slaughter-line and casing-cleaning department, the formation of air and water pollution can be reduced. Consequently, the energy consumption for waste water and air cleaning is also reduced.

There may be greater opportunities for animal by-products to be recovered or recycled if they remain fresh due to short storage times or refrigeration. For example, blood meal manufactured from refrigerated blood has a higher nutritional value than unrefrigerated blood and it can be fed to non-farmed animals, such as pets.

It may be appropriate to refrigerate animal by-products due to extreme operational difficulties, such as a long distance between the source of the materials, which makes quick treatment impossible. An additional or alternative reason may be high ambient temperatures, which cause materials to rapidly decompose and produce malodorous emissions. High temperatures may be seasonal in the north of Europe or permanent in countries with warmer climates.

Achieved environmental benefits

- Reduced biological and/or thermal decomposition, which consequently leads to lower COD, nitrogen and phosphorus levels in the waste water at the animal by-products installation.
- The formation and emission of odour-intensive substances at both the slaughterhouse and animal by-products installation is minimised. There are reduced emissions to air from the waste gas treatment system.
- There is also a reduced risk of infestation by insects, rodents and birds.

Environmental performance and operational data

To optimise the prevention of odour problems, without creating cross-media effects at either, or both, the slaughterhouse and the animal by-products installation requires co-operation between the operators of both. If the handling and storage of by-products at the slaughterhouse is not managed in such a way as to minimise odour problems beyond the actual storage time before despatch, the animal by-products installations will almost certainly have problems, even if they treat the animal by-products immediately. The odour problems associated with animal by-products do not only arise from storage before treatment. Putrescent and putrid animal by-products also produce more malodorous gaseous and liquid emissions during processing than fresh feedstock does. They consequently cause additional odour problems at WWTPs.

Where refrigeration is required, if the storage times are also kept as short as possible, then the refrigeration capacity and the energy consumption can also be minimised.

Table 2.5 shows the practice for the storage of animal by-products in the Flemish region of Belgium.

Table 2.5: Storage requirements for animal by-products in the Flemish region of Belgium

Animal by-product	Storage practice
Animal waste/material for destruction	Enclosed storage in a refrigerated room, awaiting daily removal
Pig hair (to be used)	Enclosed storage in a refrigerated room
Blood	Enclosed and refrigerated storage
Hides (after treatment)	Enclosed storage in a refrigerated room
Intestinal fat and mucus (for subsequent treatment)	Enclosed storage in a refrigerated room
Washed intestines (if unsalted)	Refrigerated storage
Washed intestines (if salted)	Enclosed storage
Dung, contents of stomachs, intestines and rumens	No stipulations in respect of enclosed storage, refrigerated storage or removal frequency
Sludge from grease trap	Enclosed storage (airtight packaging)
<i>Source:</i> [130, COM 2005]	

Cross-media effects

Energy consumption may be required for refrigeration, if by-products cannot be used or disposed of before they start to produce malodorous substances, especially in summer and in warm climates.

The early despatch of animal by-products can increase the numbers of journeys between the slaughterhouse and the installations processing animal by-products and/or edible co-products, transporting smaller loads, and consequently lead to an increase in the environmental harm due to transport.

Technical considerations relevant to applicability

Applicable in all slaughterhouses and installations processing animal by-products and/or edible co-products.

Cooling of animal by-products and/or edible co-products should be carefully assessed, since energy is again consumed for heating the cooled by-product at the installation processing animal by-products and/or edible co-products [156, TWG 2019].

Economics

For a slaughterhouse killing 600 pigs per hour, it has been reported that the cost of a tank for blood and refrigeration equipment is about EUR 65 000-70 000 (2001). It has been reported that for slaughterhouses producing animal by-products with no commercial value, investment in storage facilities is not a viable option. This may be the case if the by-products are treated or removed before they cause an odour nuisance.

There may be contractual arrangements affecting the price paid to slaughterhouses for raw materials, which depend on the quality of raw material provided, if the animal by-products are destined for further use. If the materials are destined for disposal, the cost of dealing with problems, such as odour due to material not being provided fresh, may be passed on to the slaughterhouse, so investment in early despatch or refrigerated storage may be cost-effective.

Driving force for implementation

- Prevention of odour emissions.
- Requirements for temperature conditions in Commission Regulation (EU) No 142/2011.

In Denmark, the cooling of blood at slaughterhouses was introduced due to a demand from the environmental regulatory authorities, in order to reduce the odour emissions, during the handling and transportation of blood.

Example plants

This technique has been reported by approximately 20 % of the slaughterhouses and 15 % of the installations processing animal by-products and/or edible co-products participating in the SA data collection. For example, a turkey slaughterhouse (PL289) implemented refrigeration in the storage of blood [178, TWG 2020].

Reference literature

[8, VDI 2008], [203, VDI 1996], [23, Nordic 2001], [58, UECBV 2002], [62, Germany 2002], [156, TWG 2019] [173, EFPA-EAPA 2020], [178, TWG 2020].

2.3.2.7 Phosphorus recovery as struvite

Description

Phosphorus contained in waste water streams is recovered by precipitation in the form of struvite (magnesium ammonium phosphate).

Technical description

In the case of waste water containing high concentrations of phosphate, phosphorus can be recovered by precipitation of struvite. The reaction takes place by adding magnesium, at pH levels of 7.5 to 10. The result will be the formation of struvite (magnesium ammonium phosphate):



The most common technique for phosphorus recovery as struvite is carried out using waste water in stirred tank reactors, after anaerobic digestion. The waste water is usually aerated in a first tank (see Figure 2.37), which results in a pH increase due to CO₂ stripping. The process continues in a second reactor (where the magnesium chloride or magnesium oxide is mixed with the waste water) and a separation unit, where struvite is removed from the waste water, dewatered and dried. Recovered struvite has a crystal structure that is pure and can be reused as a fertiliser.

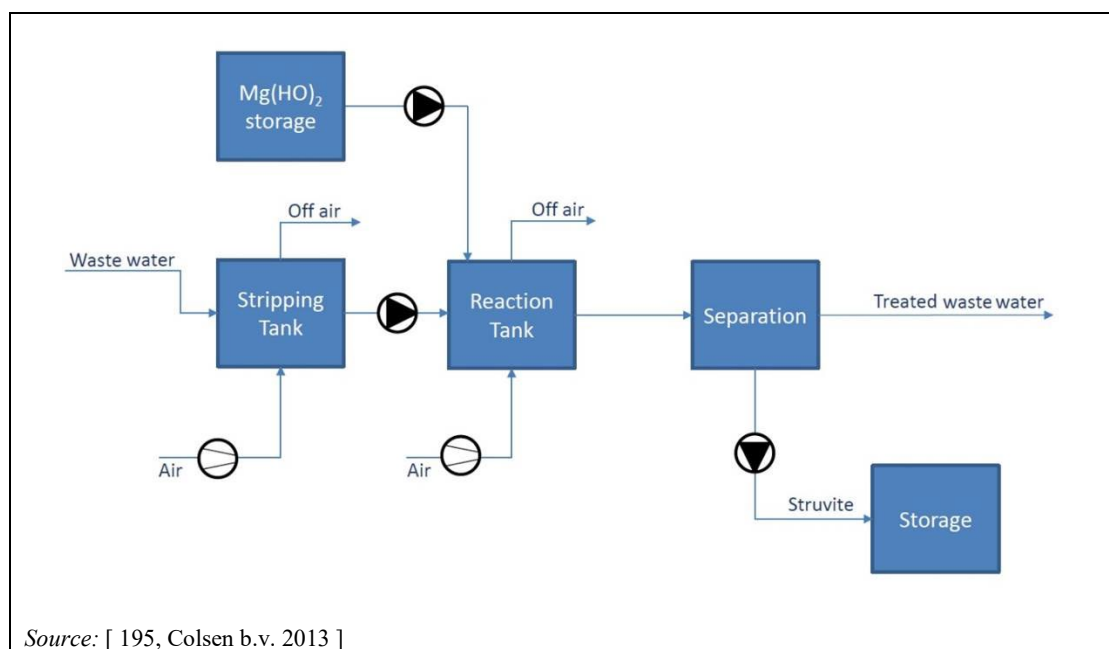

Figure 2.37: Flow diagram for one example of phosphorus recovery as struvite

Struvite can also be recovered from sewage liquors, sewage sludge digestate or liquid slurry, with tens of installations operating at full scale worldwide, or from manure digestate or certain industry waste waters (semi-conductor industry, fertiliser industry, etc.) Other similar techniques exist at

the development stage or operating at full scale for municipal waste waters or manures, recovering other phosphate salts (e.g. potassium struvite, brushite) or phosphoric acid which can be used in industry or converted to phosphate fertiliser products. For a general description of chemical precipitation, see Section 2.3.6.5.1.

Achieved environmental benefits

- Reduced total phosphorus emission levels.
- Reduction of sludge production in the WWTP compared to chemical phosphorus precipitation.
- Recovery of phosphorus for other uses (e.g. as fertiliser).

The EU depends on imports for more than 90 % of its mined phosphorus. Phosphate rock and white phosphorus P₄ are both on the EU List of Critical Raw Materials.

Environmental performance and operational data

Average removal efficiencies of 80-90 % have been reported from the application of this technology in the food sector. The effluent concentration that can be reached is no lower than 10-20 mg P-PO₄/l. When phosphate is recovered from the sewage sludge directly after anaerobic digestion, the risk of scaling problems in the remainder of the sludge line can be significantly reduced.

Cross-media effects

No information provided.

Technical considerations relevant to applicability

The technique is only applicable to waste water streams with a high total phosphorus content (e.g. above 50 mg/l) and a significant flow.

Economics

An investment cost of around EUR 983 000 for the treatment of 120 m³/h of waste water has been reported, for achieving an outlet P-PO₄ concentration of 20 ppm (inlet P-PO₄ concentration around 150 ppm) [121, Giner-Santonja et al. 2019]. The cost of recovery is lower compared to phosphorus removal by chemical precipitation using, for example, FeCl₃.

Phosphorus recovery as struvite can also result in a decrease in the costs for the treatment and disposal of sludge. There are potential revenues from selling the recovered struvite.

Driving force for implementation

In conventional waste water treatment plants, the remaining phosphorus is mainly eliminated by chemical precipitation with metal salts. However, large amounts of chemicals are required to obtain low emission levels (1 mg/l or 2 mg/l of TP), and large volumes of sludge are produced. Furthermore, metal phosphate salts, such as iron or aluminium, cannot be reused in agriculture because the iron or aluminium phosphates are not available for plants under normal pH conditions. Due to the presence of iron or aluminium (which are added to precipitate phosphates) and the increasing contamination of waste water sludge with heavy metals and toxic organic substances, its application in agriculture has become increasingly unpopular or has been phased out completely [196, Desmidt et al. 2015].

The recovered phosphate can be reused as a fertiliser, either directly or after further processing, improving the economic feasibility of the investment. For direct use as a fertiliser, the struvite produced has to be certified and recognised. Phosphorus recovery as struvite can help to prevent scaling problems in the WWTP.

Example plants

No information provided.

Reference literature

[121, Giner-Santonja et al. 2019], [195, Colsen b.v. 2013], [196, Desmidt et al. 2015], [197, NuReSys 2016].

2.3.2.8 Integrated site - slaughterhouse and rendering plant**Description**

Operation of a rendering plant on a slaughterhouse site.

Technical description

A rendering plant may be operated on a slaughterhouse site. The by-products of the slaughter process and on-site waste water treatment may be treated on a continuous basis, thereby minimising the need for collection and transport, for use or disposal off site, and the need for storage.

Achieved environmental benefits

Reduced energy consumption, reduced production of malodorous substances and reduced need for energy required for their treatment.

Environmental performance and operational data

Heat in the system can be recovered in the form of hot water and used, e.g. as cleaning water in the slaughterhouse.

The use of the tallow as a fuel could, in theory, make the installation largely self-sufficient in terms of heating.

Putrescible materials are used quickly, so there is minimal raw material degradation. The waste water treatment plant is not required to treat the products of decomposition and the odour problems associated with such treatment are thus avoided. The need for a frequent collection service is also avoided.

Category 1, 2 and 3 animal by-products can either be treated in separate rendering units or in combination, although mixtures containing Category 1 materials are deemed to be Category 1 and mixtures of Category 2 and 3 materials are deemed to be Category 2 and must be treated as such, as prescribed in the ABP Regulation (Regulation (EC) No 1069/2009).

Integrated sites minimise the storage times and ensure that the existing boiler is available for the destruction of the non-condensable gases produced during rendering.

Cross-media effects

None in addition to those associated with slaughtering and rendering.

Technical considerations relevant to applicability

Applicable in all SA installations.

Economics

The costs of separate collection and disposal of the various ABP Regulation categories of animal by-products are saved. The investment and running costs of odour prevention and treatment techniques are minimised, during storage, processing and waste water treatment.

Payback periods of 2-3 years have been reported, for installing a rendering system on a slaughterhouse site. The calculations included savings achieved by minimising the costs of collection, processing, cooling and concentration. They also took account of the value of saleable end products, minus variable operating costs. Cost savings on transport, environmental protection and energy were also identified.

Driving force for implementation

Cost savings.

Example plants

Various SA installations.

Reference literature

[98, RenCare 2002].

2.3.3 Monitoring

2.3.3.1 Overview

Real data are required on the precise effects of the activities of the industrial site on the environment. It is thus necessary to implement a planned, regular sampling and monitoring programme. The parameters monitored include:

- point sources' channelled, diffuse and fugitive emissions to the atmosphere, water or the sewer;
- wastes;
- contamination of land, water and air;
- use of water, fuels, energy, oxygen, nitrogen and other gases;
- discharge of thermal energy, noise, odour and dust;
- effects on specific parts of the environment and ecosystems;
- on-site accidents and near misses;
- staff injuries;
- transport accidents;
- complaints from community residents.

Monitoring, however, is not restricted to analytical measuring. It also includes regular maintenance, and visual and safety checks.

Parallel to this document, a Reference Report on Monitoring of Emissions to Air and Water from IED installations [172, Brinkmann et al. 2018] exists to which the reader is referred for further information.

2.3.3.2 Integrated monitoring system

Description

Integrated monitoring system, formed by a large amount of measuring equipment and permitting the tracking of the energy, gas and water consumption from input to points of consumption.

Technical description

An integrated monitoring system is formed by a large amount of measuring equipment and it permits the tracking of the energy, gas and water consumption from input to points of consumption. The system can obtain data from measuring equipment, such as calorimeters, electric watt-hour meters and gas meters.

Monitoring of water and energy consumption could include direct measurements, calculation or recording, e.g. using suitable meters or invoices. The monitoring is broken down at the most appropriate level (e.g. at process or plant/installation level) and considers any significant changes in the plant/installation.

This technique could also include a system of hardware and software for the automatic detection of electric energy and water consumption. It allows the constant monitoring of installation energy

consumption (process consumption and utilities such as air compressors, air treatment units, refrigeration units and lighting), the detection of deviations and the estimation of the consumption reduction.

Achieved environmental benefits

Benefits include the control and measurement of water and energy consumption in an integrated way. This permits the main points of consumption and potential points of savings to be identified, consumption levels to be controlled, points of losses or incorrect functioning to be identified, and achieved savings to be measured.

Environmental performance and operational data

An example of monitoring is to control temperature, by dedicated measurement and correction.

Technical considerations relevant to applicability

The technique can be implemented in the overall operation of a SA installation.

Economics

Investment and operating costs generally depend on the type of measurement and the complexity of the installation.

Driving force for implementation

The implementation of this technique is stimulated by the potential economic savings, rise in yield and efficiency, and improvement of operating conditions.

Example plants

Various SA installations.

Reference literature

[121, Giner-Santonja et al. 2019].

2.3.3.3 Monitoring of influent and effluent waste water

Description

For relevant emissions to water, monitoring of key process parameters at key locations of a waste water treatment facility.

Technical description

Proper operation of a waste water treatment facility requires the monitoring and targeted adjustment of various process parameters in the influent and effluent of the facility. Monitoring of the relevant parameters can be accomplished by online measurements (that facilitate rapid intervention and control) or analytical results derived from waste water samples. Parameters to be monitored and the frequency of monitoring depend on the characteristics of the waste water to be treated, the final effluent discharge medium and the waste water treatment techniques used within the facility, based on an inventory of waste water streams. They may include, for instance, the waste water flow, pH, temperature, conductivity, or COD/TOC.

The monitoring is carried out at key locations, e.g. at the point where the emission leaves the installation and/or at the inlet and/or outlet to pretreatment and at the inlet to final treatment. Important parameters are monitored at the level of each waste water treatment technique of the facility to ensure the proper operation of the techniques and the subsequent treatment steps.

Achieved environmental benefits

Monitoring the influent and effluent waste water of a waste water treatment facility helps to maintain the proper operation of the facility and to detect accidental releases and thus helps to prevent any possible adverse environmental effects upon discharge of waste waters.

Environmental performance and operational data

No information provided.

Cross-media effects

Some equipment, chemicals and energy are required for carrying out monitoring. The COD measurement relies on the use of very toxic compounds (i.e. mercury and/or chromate).

Technical considerations relevant to applicability

Generally applicable.

Economics

The costs associated with monitoring the influent and effluent waste water of a WWTP relate to personnel and equipment used for sampling and measurement.

Driving force for implementation

The driving force is to ensure the proper operation of the WWTP and to ensure that the required quality of the effluent waste water from the WWTP is met and in line with the effluent discharge criteria.

Example plants

Monitoring of influent and effluent in a waste water treatment facility is widely applied in SA installations throughout the EU.

Reference literature

[154, Brinkmann et al. 2016].

2.3.3.4 Monitoring of emissions to water

Description

Proper operation of a waste treatment plant requires the monitoring and targeted adjustment of various process parameters in the effluent of the waste treatment plant.

Technical description

Monitoring of the relevant parameters can be accomplished by online measurements (that facilitate rapid intervention and control) or analytical results derived from waste water samples. Parameters to be monitored and the frequency of monitoring depend on the characteristics of the waste water, which are connected *inter alia* to the type of process, to the type of raw materials in the installation, and to the final effluent discharge medium.

The monitoring of emissions is carried out in accordance with EN standards or, if EN standards are not available, ISO, national or other international standards which ensure the provision of data of an equivalent scientific quality.

Achieved environmental benefits

Monitoring the waste water of a SA installation helps to maintain its proper operation and to detect accidental releases and thus helps to prevent any possible adverse environmental effects upon discharge of waste water.

Environmental performance and operational data

This information is detailed later in this document for each type of SA installation in the dedicated chapters (Chapters 3 and 4).

Cross-media effects

Some equipment, ancillary materials and energy are required for carrying out monitoring. The COD measurement relies on the use of very toxic compounds (i.e. mercury and/or chromate).

Technical considerations related to applicability

Generally applicable to all SA installations where there are emissions to water.

Economics

The costs associated with monitoring the effluent waste water of a SA installation relate to personnel and equipment used for sampling and measurement.

Driving force for implementation

Legislation on water pollution.

Example plants

See examples in Chapters 3 and 4.

Reference literature

[172, Brinkmann et al. 2018], [154, Brinkmann et al. 2016].

2.3.3.5 Monitoring of channelled emissions to air**Description**

Proper operation of a SA installation requires the monitoring and targeted adjustment of various process parameters in its channelled emissions to air.

Technical description

Monitoring of the relevant parameters can be accomplished by online measurements (which facilitate rapid intervention and control) or analytical results derived from air samples. Parameters to be monitored and the frequency of monitoring depend *inter alia* on the type of process and on the characteristics of the raw materials processed in the installation.

The monitoring of emissions is carried out in accordance with EN standards or, if EN standards are not available, ISO, national or other international standards which ensure the provision of data of an equivalent scientific quality.

Achieved environmental benefits

Monitoring the waste gas of a SA installation helps to maintain its proper operation and to detect accidental releases and thus helps to prevent any possible adverse environmental effects upon emission of waste gas.

Environmental performance and operational data

This information is detailed later in this document for each type of SA installation in the dedicated chapters (Chapters 3 and 4).

Cross-media effects

Some equipment, ancillary materials and energy are required for carrying out monitoring.

Technical considerations related to applicability

Generally applicable to all SA installations where there are channelled emissions to air.

Economics

The costs associated with monitoring the waste gas relate to personnel and equipment used for sampling and measurement.

Driving force for implementation

Legislation on air pollution.

Example plants

See examples in Chapters 3 and 4.

Reference literature

[172, Brinkmann et al. 2018], [154, Brinkmann et al. 2016].

2.3.3.6 Odour monitoring

Description

Odour monitoring is carried out using analytical methods (i.e. physical and chemical analysis) or sensorial approaches.

Technical description

The techniques include:

- for odour concentration determination (expressed in ou_E/m^3): dynamic olfactometry (measured according to the European standard EN 13725);
- for odour in ambient air: the grid method (according to the European standard EN 16841-1) or the plume method (according to the European standard EN 16841-2) to determine the odour exposure;
- for odour perception in the surrounding area (impact): odour surveys (see odour intensity mapping and odour wheels);
- electronic noses.

To determine the odour concentration by the European Standard EN 13725 [96, CEN 2022], an air sample must be taken. The sampling techniques are similar to those used for measuring individual compounds.

Techniques for odour monitoring are described in [172, Brinkmann et al. 2018] and in [154, Brinkmann et al. 2016].

Achieved environmental benefits

The achieved environmental benefit is the minimisation of odorous emissions.

Environmental performance and operational data

See [172, Brinkmann et al. 2018] and [154, Brinkmann et al. 2016].

Cross-media effects

None.

Technical considerations related to applicability

None.

Economics

See [172, Brinkmann et al. 2018] and [154, Brinkmann et al. 2016].

Driving force for implementation

The driving forces for implementation include legislation and complaints occurring in the vicinity of the installation/site.

Example plants

See Chapters 3 and 4.

Reference literature

[154, Brinkmann et al. 2016], [172, Brinkmann et al. 2018], [96, CEN 2022].

2.3.3.7 Inventory of inputs and outputs

Description

The compilation of relevant basic data on inputs and outputs (e.g. water, energy and raw materials consumption as well as on the composition and quantity of waste water and waste gas streams – each one individually) is done in an inventory of inputs and outputs. The consumption and emitted streams are listed respective to their source, i.e. the process from which they originate. This is a key element in assessing the resource efficiency of the installation, the nature of the contaminants as well as the possibilities of reduction at the source.

Technical description

An inventory of inputs and outputs incorporates all of the following features:

- I. Information about the production process(es), including:
 - a) simplified process flow sheets that show the origin of the emissions;
 - b) descriptions of process-integrated techniques and waste water/waste gas treatment techniques to prevent or reduce emissions, including their performance (e.g. abatement efficiency).
- II. Information about energy consumption and usage.
- III. Information about water consumption and usage (e.g. flow diagrams and water mass balances).
- IV. Information about the quantity and characteristics of the waste water streams, such as:
 - a) average values and variability of flow, pH and temperature;
 - b) average concentration and mass flow values of relevant substances/parameters (e.g. COD/TOC, nitrogen species, phosphorus) and their variability.
- V. Information about the characteristics of the waste gas streams, such as:
 - a) emission point(s);
 - b) average values and variability of flow and temperature;
 - c) average concentration and mass flow values of relevant substances/parameters (e.g. dust, TVOC, NO_x, SO_x) and their variability;
 - d) presence of other substances that may affect the waste gas treatment system or plant safety (e.g. oxygen, water vapour, dust).
- VI. Information about the quantity and characteristics of the chemicals used:
 - a) the identity and the characteristics of the chemicals used, including properties with adverse effects on the environment and/or human health;
 - b) the quantities of chemicals used and the location of their use.

Achieved environmental benefits

The reduction of emissions to water and/or air. Identification of relevant waste water/waste gas streams is a prerequisite for an efficient waste water/waste gas management and for the reduction of emissions by technical and management measures.

Environmental performance and operational data

No information provided.

Cross-media effects

None.

Technical considerations related to applicability

The level of detail and the degree of formalisation of the inventory will generally be related to the nature, scale and complexity of the installation, and the range of environmental impacts it may have.

Economics

No information provided.

Driving force for implementation

Inventories may be used to assess the implementation of BAT and may constitute basic information for authorities in order to set emission limit values.

Example plants

Inventories of inputs and outputs are widely applied in SA installations throughout the EU.

Reference literature

[121, Giner-Santonja et al. 2019].

2.3.4 Techniques to increase energy efficiency

2.3.4.1 General processing techniques

2.3.4.1.1 Energy efficiency plan and audits

Description

An energy efficiency plan is part of the environmental management system (see Section 2.3.1.1) and entails defining and calculating the specific energy consumption of the activity (or activities), setting key performance indicators on an annual basis (for example for the specific energy consumption) and planning periodic improvement targets and related actions. Audits are carried out at least once every year to ensure that the objectives of the energy efficiency plan are met and the energy audits' recommendations are followed up and implemented.

Technical description

An energy efficiency plan and audits are part of the environmental management system (EMS) and include:

- energy flow diagrams;
- establishment of energy efficiency objectives;
- implementation of actions to achieve these objectives.

Audits are carried out at least annually to ensure that the objectives of the energy efficiency plan are met.

An energy audit checklist is generally used, which allows the targeting and prioritisation of the areas where the organisation can save energy. Key performance indicators can be used to measure progress against objectives [207, TWG 2023].

Management to achieve energy efficiency requires structured attention to energy with the objective of continuously reducing energy consumption and improving efficiency in production and utilities, and sustaining the achieved improvements at both company and site level. It provides a structure and a basis for determining the energy efficiency, defining possibilities for improvement and ensuring continuous improvement. All effective energy efficiency (and environmental) management standards, programmes and guides contain the notion of continuous improvement, meaning that energy management is a process, not a project which eventually comes to an end.

There are various process designs, but most management systems are based on the plan-do-check-act approach (which is widely used in other company management contexts). ISO 50001 is one of the more globally widespread standards for energy efficiency management systems.

More information on energy efficiency management systems can be found in the ENE BREF [162, COM 2009].

Some common techniques applicable to increase the energy efficiency of SA plants are as follows:

- a) Appraising the costs and benefits of different energy options.
- b) Monitoring energy flows (consumption and generation by source) and the targeting of areas for reductions (see also Section 2.3.4.1.2).
- c) Defining and calculating the specific energy consumption of the activity (or activities), and setting key performance indicators on an annual basis (e.g. MWh/tonne of carcass).
- d) Carrying out an energy survey to identify the opportunities for further energy savings.
- e) Optimising boilerhouses (reuse of condensed water, preheating of air supply, heat recovery in combustion gases) and optimising boiler design according to the energy demand profile (see also the LCP BREF [180, Lecomte et al. 2017]).
- f) Using combined heat and power (CHP).
- g) Applying operating, maintenance and housekeeping measures to the most relevant energy-consuming systems such as:
 - air conditioning, process refrigeration and cooling systems (leaks, seals, temperature control, evaporator/condenser maintenance);
 - insulation of pipes, vessels and equipment (see also Section 2.3.4.1.9);
 - operation of motors and drives (e.g. high-efficiency motors);
 - compressed gas systems (leaks, procedures for use);
 - steam distribution systems (leaks, traps, insulation);
 - management of hot water systems (see also Section 2.3.4.2.3);
 - lubrication to avoid high friction losses (e.g. mist lubrication);
 - boiler maintenance, e.g. optimising excess air;
 - other maintenance relevant to the activities within the plant;
 - reviewing equipment requirements on a regular basis.
- h) Using techniques that reduce energy consumption and thereby reduce both direct (heat and emissions from on-site generation) and indirect (emissions from a remote power station) emissions. For example:
 - building insulation;
 - use of energy-efficient site lighting (see also Section 2.3.4.1.3);
 - efficient plant layout to reduce pumping distances;
 - variable speed drives;
 - optimisation of air conditioning systems (e.g. by sections or by direct conditioning of specific weaving machines for individual adaptation of volume and humidity);
 - ensuring equipment is switched off, if safe to do so, when not in use.

Achieved environmental benefits

See energy efficiency management systems in the ENE BREF [162, COM 2009].

Environmental performance and operational data

No information provided.

Cross-media effects

See energy efficiency management systems in the ENE BREF [162, COM 2009].

Technical considerations relevant to applicability

The level of detail of the energy efficiency plan and audits will generally be related to the nature, scale and complexity of the plant.

See energy efficiency management systems in the ENE BREF [162, COM 2009].

Economics

No information provided.

Driving force for implementation

The implementation of the energy management system allows the energy consumption of the installation to be monitored.

Example plants

This technique is widely applied. It has been reported in approximately 50 % of the installations participating in the SA data collection [178, TWG 2020].

Reference literature

[162, COM 2009], [178, TWG 2020], [209, COM 2021].

2.3.4.1.2 Monitoring of energy consumption

Description

Monitoring of energy consumption, as part of the energy efficiency plan (see Section 2.3.4.1.1).

Technical description

Monitoring comprises the establishment of a register of energy-consuming processes and of all single aggregates including air conditioning and lighting. If no energy consumption meters are installed, the power values of aggregates are registered together with the estimated mean consumption and running times. Consumption data are connected to cost data according to each energy source.

Achieved environmental benefits

Reduction of the environmental impact associated with energy production by identification of the main energy consumers and related efficient prioritisation of improvement measures as well as by awareness-raising and training of employees.

Environmental performance and operational data

For monitoring consumption, indicators are defined for the entire plant and for single processes, together with determined periods for data collection, e.g. energy consumption (gas, oil, etc.) per tonne of steam produced, electricity consumption for compressed air per tonne of product produced, electricity consumption per tonne of product produced, consumption of steam and electricity per processed good or group of goods, consumption of steam and electricity per processed good.

Consumption data are communicated to the workers in charge of the respective process, and training on reduction measures conducted.

Based on the latest up-to-date energy cost data, the economic viability of potential energy-saving measures are regularly recalculated.

Cross-media effects

None identified.

Technical considerations relevant to applicability

Generally, there are no technical restrictions to the applicability of this technique.

Restrictions for the use of consumption meters may occur in existing installations if potential energy savings are expected to be low in relation to the meter installation costs.

Economics

No information provided.

Driving force for implementation

Energy savings.

Example plants

This technique is widely applied.

Reference literature

[161, Roth et al. 2023].

2.3.4.1.3 Lighting management systems and energy-efficient lighting**Description**

Ensuring the application of an efficient lighting system in the installation.

Technical description

Incorporation of energy-efficient lamps, use of light reflectors and optimisation of lighting (lux optimisation) for different processes can contribute to energy-efficient lighting in the installation.

The use of management systems (e.g. automatic controls) can further reduce energy consumption. For instance, in rooms which are not regularly occupied, such as the packaging materials store and the hide room, the lighting can be sensor-controlled.

Achieved environmental benefits

Reduced energy consumption.

Environmental performance and operational data

Any requirements for emergency lighting, for health and safety or fire purposes, cannot be compromised.

Cross-media effects

None.

Technical considerations relevant to applicability

Applicable in all SA installations.

Driving force for implementation

Reduced energy consumption and associated costs.

Example plants

This technique has been reported in approximately 40 % of the installations participating in the SA data collection [178, TWG 2020].

Reference literature

[23, Nordic 2001], [31, Greek Ministry for the Environment 2001], [108, Clitravi - DMRI 2003], [69, May G.E. 2001], [178, TWG 2020].

2.3.4.1.4 Heat recovery

Description

Use of heat exchangers and heat pumps to recover heat.

Technical description

The SA sector has plenty of examples of heat recovery. The most commonly used heat recovery methods are the following:

- direct usage: heat exchangers make use of heat as it is in the surplus stream;
- heat pumps upgrade the heat in relatively cold streams so that it can perform more useful work than could be achieved at its present temperature (i.e. an input of high-quality energy raises the energy quality of the waste/surplus heat).

Heat can be also recovered from the blowdown of a boiler.

Another example of heat recovery is related to air compressors. From 80 % to 90 % of the mechanical energy that is consumed by compressors in an air-compressed system is converted to thermal energy. This causes an increase in air temperature and for this reason a compressor cooling system is required. In this way, this heat can be recovered and reused. The heat output from air compressors can be crossed with water or air to transfer the heat and, then, the heat can be reused. Heating systems, drying processes and the heat feed to the steam boiler or oven burners are the main applications of the heated airstream. The applications of heated water streams are varied.

Achieved environmental benefits

Reduction of energy consumption.

Environmental performance and operational data

There are multiple ways of heat recovery reported in the questionnaires of the SA BREF data collection. Some examples are presented in Table 2.6.

Table 2.6: Various examples of heat recovery in the SA sector

Type of SA activity	Source of heat	Purpose of recovery	Example installations
Slaughterhouses	Refrigeration plants	Heating of washing and domestic water, avoiding condensation in slaughter room, defrosting cooling units, compressors, water for heating/cooling system	BE020, BE024, FR238, FR249, FR256, PL289, PT269, SE185, SE186
	Pig singeing exhaust gases	Cooling system, preheating of water	BE030, DE063, DE064, various Finnish pig slaughterhouses (see also Section 3.3.4.1.2)
	Hot water used for showering carcasses	Preheating of water	FR242
Rendering and fat melting plants	Waste gas from cooking/drying process	Hot water for cleaning, scalding, district heating system	AT017, BE020, DE072, DE073, DE074, FI143
	Steam condenser	Heating fat and water	ES132
	Boiler	Heating of cleaning water, make-up water for steam boiler	BE020, BE025

Type of SA activity	Source of heat	Purpose of recovery	Example installations
	Condensate from steam circuit	Heating of cleaning water	ES139, FR241, IT262
	Thermal boiler linked to a thermal oxidiser	Steam for the rendering process	FR250
Fishmeal and fish oil plants	Drying of press cake, grax and evaporated stickwater in a falling film evaporator	Evaporating water from stickwater	A fishmeal and fish oil factory in Denmark (see also Section 4.4.4.1.1)
	Dryer, evaporator	Heating of raw material, evaporator, district heating	DE071, DK092, NO280, NO281
	Boiler	Boiler	FR245
<i>Source:</i> [130, COM 2005], [167, Spain 2020], [178, TWG 2020]			

Cross-media effects

Lower temperatures of exhaust gases in chimneys can lead to poorer dispersion of the flue-gases [204, TWG 2021].

Technical considerations relevant to applicability

Heat recovery opportunities are present in existing and new SA installations. As indicated in the ENE BREF [162, COM 2009], heat recovery is not applicable where there is no demand that matches the production curve.

Economics

See Table 2.6.

Driving force for implementation

Energy savings.

Example plants

Heat recovery is commonly reported in various SA sectors. This technique has been reported in approximately 50 % of the installations participating in the SA data collection [178, TWG 2020].

Reference literature

[130, COM 2005], [162, COM 2009], [167, Spain 2020], [178, TWG 2020], [204, TWG 2021].

2.3.4.1.5 Energy-efficient motors

Description

Use of high-efficiency motors to minimise motor losses.

Technical description

Motor losses can be minimised by specifying higher efficiency motors where feasible. More information on energy-efficient motors can be found in the ENE BREF [162, COM 2009].

Achieved environmental benefits

Reduced energy consumption.

Environmental performance and operational data

See energy-efficient motors in the ENE BREF [162, COM 2009].

Cross-media effects

See energy-efficient motors in the ENE BREF [162, COM 2009].

Technical considerations relevant to applicability

Applicable where motors are used.

Economics

Reduced energy costs.

Driving force for implementation

Reduced energy costs.

Example plants

This technique has been reported in approximately 65 % of the installations participating in the SA data collection [178, TWG 2020].

Reference literature

[162, COM 2009].

2.3.4.1.6 Frequency converters on motors

For more information, consult the ENE BREF [162, COM 2009] and the FDM BREF [121, Giner-Santonja et al. 2019].

Description

Frequency converters (or variable speed drives) regulate the speed of the impeller to the required output of the motor.

Technical description

Controlling the speed of the pump motor by frequency converters ensures that the speed of the impeller is exactly adapted to the required output of the pump, as are the power consumption and treatment of the liquid. More information on frequency converters (or variable speed drives) can be found in the ENE BREF [162, COM 2009].

Achieved environmental benefits

Reduced energy consumption.

Environmental performance and operational data

The reduction of the power consumption depends on the capacity and number of pumps and motors. Generally, a 10 % reduction in the output of a pump corresponds to a 28 % reduction in the power consumption of the pump.

Cross-media effects

See variable speed drives in the ENE BREF [162, COM 2009].

Technical considerations relevant to applicability

Frequency converters can be used with standard three-phase motors. They are available for both manual and automatic speed controls. They can be applied in existing and new installations for pumps, ventilation equipment and conveying systems. It is reported that frequency-converter-driven motors should not exceed 60 % of the total energy use of the installation because they can have an adverse effect on the electricity supply and can lead to technical problems.

Economics

The price of a 5.5 kW frequency converter is about EUR 600 [121, Giner-Santonja et al. 2019].

Driving force for implementation

Reduced consumption of electrical power in combination with a more gentle treatment of the product.

Example plants

This technique has been reported in approximately 55 % of the installations participating in the SA data collection [178, TWG 2020].

Reference literature

[121, Giner-Santonja et al. 2019], [162, COM 2009], [178, TWG 2020].

2.3.4.1.7 Process control systems**Description**

Automation of a facility to switch off equipment when it is not needed.

Technical description

Automation of a manufacturing facility involves the design and construction of a process control system, requiring sensors, instruments, computers and the application of data processing. It is widely recognised that automation of manufacturing processes is important not only to improve product quality and workplace safety, but also to increase the efficiency of the process itself and contribute to energy efficiency. More information on process control systems can be found in the ENE BREF [162, COM 2009].

Achieved environmental benefits

Reduced energy consumption.

Environmental performance and operational data

See process control systems in the ENE BREF [162, COM 2009].

A cattle slaughterhouse (IE154) implemented carcass chill temperature controls. Temperature probes inserted into the carcass feed information back to a control module that controls the amount of cooling required to get the carcass to the core temperature required by food safety standards. The compressor is managed to reduce energy consumption down to 3 % of the total electricity consumption [178, TWG 2020].

Cross-media effects

See process control systems in the ENE BREF [162, COM 2009].

Technical considerations relevant to applicability

None reported.

Economics

See process control systems in the ENE BREF [162, COM 2009].

The economic cost for installation of the probes in IE154 was EUR 50 000 across five carcass chillers. The main cost was due to PLC development to control the compressors. The electricity savings were EUR 19 800/year [178, TWG 2020].

Driving force for implementation

Reduced energy costs.

Example plants

This technique has been reported in approximately 50 % of the installations participating in the SA data collection [178, TWG 2020].

Reference literature

[121, Giner-Santonja et al. 2019], [162, COM 2009], [178, TWG 2020].

2.3.4.1.8 Combined heat and power generation (cogeneration)

For more information, consult the ENE BREF [162, COM 2009] and the FDM BREF [121, Giner-Santonja et al. 2019].

Description

Use of a heat engine or power station to generate electricity and useful heat at the same time.

Technical description

Information on different cogeneration applications can be found in the ENE BREF [162, COM 2009].

Achieved environmental benefits

Reduced energy consumption and emissions to air, e.g. NO_x, CO₂ and SO₂.

Environmental performance and operational data

The energy efficiency of combined heat and power generation (CHP) plants can be as high as 90 %. This optimises the use of fossil fuels and reduces the production of CO₂. New CHP installations save at least 10 % of the fuel otherwise used in the separate production of heat and electricity. Furthermore, gas-fired CHP plants can eliminate SO₂ emissions and NO_x can be controlled to comply with environmental legislation. Modern CHP equipment is likely to require less effort to operate and maintain than many older boiler systems, as it is equipped with automatic control and monitoring systems.

Economics

A decision on whether to implement CHP generation based on investigation of the economic aspects will take account of the price of gas and electricity. A balance of relatively expensive gas or other fuels and cheap electricity mitigates against the selection of CHP generation.

Cross-media effects

See cogeneration in the ENE BREF [162, COM 2009].

Technical considerations relevant to applicability

The applicability of CHP very much depends on several technical aspects. A simple rule of thumb is that the site needs to have a simultaneous demand for heat and electricity for at least 4 000 hours a year.

The applicability to existing plants may be restricted by lack of a suitable heat demand and/or by the plant layout/lack of space.

Driving force for implementation

The introduction of measures and procedures to promote cogeneration installations is supported by Directive 2012/27/EU of the European Parliament and of the Council of 25 October 2012 on energy efficiency.

Example plants

This technique has been reported in 11 slaughterhouses and 6 installations processing animal by-products and/or edible co-products participating in the SA data collection [178, TWG 2020].

Reference literature

[121, Giner-Santonja et al. 2019], [162, COM 2009], [178, TWG 2020].

2.3.4.1.9 Insulation of pipes, vessels and other equipment

Description

Insulation of pipes, vessels and other equipment by selecting effective coating materials.

Technical description

Insulation of pipes, vessels and other equipment such as ovens and freezers can minimise energy consumption. Insulation can be optimised by selecting effective coating materials that are thick and have low conductivity values and by using pipes, vessels and equipment that are insulated prior to installation. Pre-insulation has the advantage that the pipe supports are mounted outside the insulation coating instead of being directly connected for example. This reduces the heat loss through the mounts.

Insufficient insulation of pipework can lead to excessive heating of the surrounding process areas as well as the risk of burn injuries.

Some examples in the SA sector are the following:

- Insulation of scalding tanks in pig and poultry slaughterhouses: The scalding tank can be insulated to reduce the heat loss through the sides and covered to reduce evaporation and heat loss from the water surface. The surface may be covered with plastic balls.
- Insulation of bone de-fatting equipment in gelatine manufacturing: The bone de-fatting process emits heat in quantities sufficient to make the equipment and associated metalwork, such as walkways and handrails, hot to touch. The equipment can be insulated to minimise such heat losses and to reduce energy consumption.

Achieved environmental benefits

Reduced energy consumption and associated fuel consumption and emissions to air. Covering of scalding tanks also reduces odour emissions.

Environmental performance and operational data

Insulation of pipes and tanks can reduce the heat/cold loss by 82-86 %. Additionally, 25-30 % heat can be saved by using pre-insulated pipes instead of traditionally insulated ones.

For a scalding tank with a capacity to handle 210 pigs per hour, with the dimensions of: length approximately 43 meters, area of sides and bottom about 100 m² and surface area 22 m², the following data have been reported: heat loss of about 370 000 kJ (103 kWh) per hour, of which 53 % is lost through the sides and bottom and 47 % from the surface. The heat loss can be reduced from 1.73 kWh to 1.35 kWh per pig (from 22.5 kWh/t to 17.2 kWh/t of pig carcass) by applying insulation and covering of the scalding tank.

Cross-media effects

No information provided.

Technical considerations relevant to applicability

Applicable to all SA installations. Pre-insulated pipes are applicable in new installations and where pipework, vessels and other equipment are replaced.

Economics

Insulation of a scalding tank used for about 360 pigs per hour cost EUR 55 000 (2005 value). There are conflicting reports about the applicability in existing slaughterhouses. One view is that the payback time for the insulation of tanks is 1 to 3 years. Another view states that existing scalding tanks can be insulated, but the cost will normally only be recouped in connection with the replacement or alteration of the system.

Driving force for implementation

Reduction in energy costs.

Example plants

This technique has been reported in approximately 45 % of the installations participating in the SA data collection [178, TWG 2020].

Reference literature

[9, DoE 1993], [23, Nordic 2001], [37, Pontoppidan O. 2001], [118, Denmark 2015], [121, Giner-Santonja et al. 2019], [178, TWG 2020].

2.3.4.1.10 Combustion regulation and control

Description

Combustion regulation and control can be used to control boiler combustion by monitoring and controlling fuel flow, air flow, oxygen levels in the flue-gas and heat demand.

Technical description

Excess air can be minimised by adjusting the air flow rate in proportion to the fuel flow rate. This is greatly assisted by the automated measurement of the oxygen content in the flue-gases. Depending on how fast the heat demand of the process fluctuates, the excess air level can be manually set or automatically controlled. Too low an air level causes extinction of the flame, then re-ignition and backfire, causing damage to the installation. This improvement minimises the heat loss due to unburnt gases and to elements in solid wastes and residues from combustion, e.g. through the slag.

More information on optimisation of combustion and advanced control systems can be found in the ENE BREF [162, COM 2009] and the LCP BREF [180, Lecomte et al. 2017].

Achieved environmental benefits

Reduced energy consumption and emissions to air.

Environmental performance and operational data

There will be an initial set-up stage, with periodic recalibration of the automatic controls.

Cross-media effects

As excess air is reduced, unburnt components like carbonaceous particulates, carbon monoxide and hydrocarbons are formed and may exceed emission limit values. This limits the possibility of energy efficiency gains by reducing excess air. In practice, excess air is adjusted to values where emissions are below the limit value.

Technical considerations relevant to applicability

Generally applicable.

Economics

No information provided.

Driving force for implementation

Reduced energy costs.

Example plants

This technique has been reported in approximately 45 % of the installations participating in the SA data collection [178, TWG 2020].

Reference literature

[162, COM 2009], [178, TWG 2020], [180, Lecomte et al. 2017].

2.3.4.1.11 Pre-cleaning of blood and meat juice contamination with cold water**Description**

Application of cold water instead of hot water for pre-cleaning in areas where the dominant by-products are blood and meat juice.

Technical description

In areas where the dominant by-products are blood and meat juice, the initial pre-cleaning can be carried out with cold water. Hot water makes blood stick to the surfaces being cleaned. Hot water only needs to be used in areas with fatty waste.

Dry scraping of blood and meat juice prior to cleaning should be used where applicable to minimise water consumption.

Achieved environmental benefits

Reduced energy consumption for heating the water for the initial rinsing and for subsequent cleaning, which would be required due to the adherence of materials to surfaces being cleaned. Reduced use of detergents and contamination of waste water by detergents.

Environmental performance and operational data

No information provided.

Cross-media effects

No information provided.

Technical considerations relevant to applicability

Applicable to all SA installations.

Economics

There is an immediate cost saving.

Driving force for implementation

Reduced energy costs.

Example plants

No information provided.

Reference literature

[23, Nordic 2001], [31, Greek Ministry for the Environment 2001].

2.3.4.1.12 Optimisation of design and operation of cooling system(s)**Description**

Design and operation of the cooling system(s) is optimised to minimise the energy (electricity) consumption and refrigerant losses.

Technical description

The following optimisation design features/techniques are considered:

- indirect cooling systems;
- pre-assembled piping, welded connections, and leak-tight valves;
- recovery of the refrigerant from the system;
- minimised refrigerant charge (quantity);
- retrofitting older cooling systems with new, sophisticated and sensitive equipment (with programmable logic controllers and higher fault/load sensitivity);
- heat exchangers added on the condenser side of the cooling systems.

The following operational techniques are used to optimise the energy consumption of the cooling system(s):

- Correct adjustment of the working parameters
Major energy savings in cooling and freezing are possible by correct adjustment of the working parameters, such as the evaporator temperature, conveyor belt speed and blower power in the freezing tunnel.
- Optimisation of condensation and evaporation temperature of cooling systems
The reduction of the condensation temperature raises the coefficient of performance (COP) of the refrigeration system (cycle). This can be achieved by fitting an adequate capacity of condenser batteries (to keep the temperature low in summers) and ensuring the low temperature of air entering the condensers (keeping them in the shade away from sunlight exposure). Similarly, the raising of the evaporation temperature improves energy performance. This is achieved with careful calibration of the flow rate and load of the production line/tunnels.

Achieved environmental benefits

- Reduced energy consumption.
- Reduced refrigerant losses.

Environmental performance and operational data

Modern refrigeration equipment has progressively been designed to operate more efficiently with components and refrigerant charges optimised. The replacement of old equipment with modern equipment typically reduces power consumption and refrigerant losses. However, modern equipment and components may be more susceptible to performance degradation from lack of maintenance or refrigerant leakage compared to older, less optimised systems.

Modern refrigeration equipment typically has an optimised or critical refrigerant charge, optimised speed (frequency) controlled compressors, advanced surface heat exchangers (i.e. micro-channel), and intelligent electronic sensors and controls. By design, there is minimal 'spare capacity' in the system, which relies on the correct optimal performance of each component to meet its tested/rated performance capabilities. Therefore, the specific fault responses for modern equipment may be different to the responses for older generation equipment, and maintenance may be even more important for high/super-high-efficiency equipment to allow it to achieve its full operational potential.

Conversely, the new capabilities of modern technology, such as wireless monitoring, automatic fault detection and diagnosis and cloud-based machine-learning algorithms can facilitate, flag and optimise the maintenance delivery process.

In a French slaughterhouse, the key technical solutions included:

- replacing the HCF-refrigerant unit with a low-ammonia-load unit;
- condensation on a plate condenser with mono ethylene glycol (MEG) dry cooler at 38/42 °C and another dry cooler for free cooling when outside temperatures are low, coupled with a hot-water recovery circuit of 500 kW for preheating the water supply to the natural-gas-fired domestic hot water heater (ECS), as well as the glycol heating used for defrosting;
- use of a glycol which does not need added water;
- installation of a variable speed drive on the distribution pumps;
- installation of a 160-kW plate heat exchanger, which recovers energy from the refrigeration unit and feeds it back into the water network to preheat hot water.

Cross-media effects

None reported.

Technical considerations relevant to applicability

Generally applicable in all SA installations.

Economics

Higher capital costs for optimised cooling systems are generally compensated by lower maintenance costs or increased energy efficiency.

In a French slaughterhouse, the overall investment was high (around EUR 500 000) for the retrofitting of heating and cooling systems, but resulted in EUR 77 000/year of cost savings for electricity and gas consumption (around 6.4-year payback period – gross return on investment, at constant energy cost).

Driving force for implementation

- Lowering operational (e.g. electricity) costs.
- Lowering indirect emissions from electricity production (depending on the grid CO₂ intensity).

Example plants

Slaughterhouses in France.

Reference literature

[210, EEB 2023].

2.3.4.2 Techniques related to steam systems**2.3.4.2.1 Feed water preheating (including the use of economisers)**

For more information, consult standard and condensing economisers in the FDM BREF [121, Giner-Santonja et al. 2019].

Description

Heat exchanger which reduces steam boiler fuel requirements by transferring heat from the flue-gas to the incoming feed water.

Technical description

The economiser is already a very common and standard solution to recover energy in steam boilers and other heat sources. Very briefly, it is a heat exchanger located in the flue-gas of combustion, which can be useful for low-grade heat applications, such as water preheating.

Achieved environmental benefits

Reduced energy consumption.

Environmental performance and operational data

An economiser has to be designed and fitted according to the boiler design, and this will define its working range and conditions for maximum efficiency. Water preheating should be limited to avoid boiling, by ensuring a minimum flow through the economiser. Flue-gases should not be cooled below the condensation point, except in the case of a condensing economiser.

Cross-media effects

Only in the case of condensing economisers, a small amount of low pH waste water is generated, from the combustion water condensation.

Technical considerations relevant to applicability

Generally, there are no technical restrictions to the applicability of this technique.

Economics

No information provided.

Driving force for implementation

Reduced energy costs.

Example plants

This technique has been reported in approximately 45 % of the installations participating in the SA data collection [178, TWG 2020].

Reference literature

[121, Giner-Santonja et al. 2019], [178, TWG 2020].

2.3.4.2.2 Minimisation of the blowdown of boilers

For more information, consult the FDM BREF [121, Giner-Santonja et al. 2019].

Description

Measures such as pretreating the water, maximising the recovery of condensate, using an automated blowdown control system, or flashing the blowdown at medium or low pressure.

Technical description

The blowdown of a boiler is used to limit the accumulation of salts (e.g. chlorides, alkalis and silicic acid) and is therefore necessary to keep these parameters within prescribed limits. It is also used to remove the sludge deposits (e.g. calcium phosphates) and corrosion products (e.g. ferric oxides) from the boiler and to keep the water clear and colourless. Waste water at high pressure and temperature is always discharged, either for a set time or continuously. It is therefore preferable to restrict the blowdown as far as possible.

Achieved environmental benefits

- Reduced energy consumption.
- Reduced waste water generation.

Environmental performance and operational data

At a steam pressure of 10 bar, a fuel saving of 2.1 % can be achieved if the blowdown volume is reduced by 10 %.

Cross-media effects

Discharges of treatment chemicals, chemicals used in deioniser regeneration, etc.

Technical considerations relevant to applicability

Applicable where a boiler is used.

Economics

The payback period of condensate return will depend on the condensate flow rates and temperature [121, Giner-Santonja et al. 2019].

Driving force for implementation

Reduced energy costs.

Example plants

This technique has been reported in approximately 40 % of the installations participating in the SA data collection [178, TWG 2020].

Reference literature

[121, Giner-Santonja et al. 2019], [178, TWG 2020].

2.3.4.2.3 Optimisation of steam distribution systems

Description

Implementation of a maintenance system to minimise leaks and selection of appropriate steam traps and insulation.

Technical description

The distribution system transports steam from the boiler to the various end uses. Although distribution systems may appear to be passive, in reality these systems regulate the delivery of steam and respond to changing temperatures and pressure requirements. Consequently, proper performance of the distribution system requires careful design practices and effective maintenance. The piping should be properly sized, supported, insulated and configured with adequate flexibility. Pressure-regulating devices such as pressure-reducing valves and backpressure turbines should be configured to provide a proper steam balance among the different steam headers. Additionally, the distribution system should be configured to allow adequate condensate drainage, which requires adequate drip leg capacity and proper steam trap selection.

Maintenance of the system is important, especially:

- to ensure that traps operate correctly;
- to ensure that insulation is installed and maintained;
- to ensure that leaks are detected and dealt with systematically by planned maintenance; this is assisted by leaks being reported by operators and dealt with promptly; leaks include air leaks on the suction side of pumps;
- for checking for and eliminating unused steam lines.

More information on optimising steam distribution systems can be found in the ENE BREF [162, COM 2009].

Achieved environmental benefits

Reduced energy consumption.

Environmental performance and operational data

See optimising steam distribution systems in the ENE BREF [162, COM 2009].

Cross-media effects

See optimising steam distribution systems in the ENE BREF [162, COM 2009].

Technical considerations relevant to applicability

Generally applicable.

Economics

See optimising steam distribution systems in the ENE BREF [162, COM 2009].

Driving force for implementation

Reduced economic costs.

Example plants

This technique has been reported in approximately 40 % of the installations participating in the SA data collection [178, TWG 2020].

Reference literature

[162, COM 2009], [178, TWG 2020].

2.3.4.2.4 Use of thermostatically controlled steam- and water-blending valves

See also Section 2.3.4.1.7.

Description

Use of thermostatically controlled steam- and water-blending valves that automatically control the water temperature.

Technical description

Thermostatically controlled steam- and water-blending valves that automatically control the water temperature can remove the risk of an untrained or overcautious operator setting water temperatures too high and consequently using excessive amounts of energy.

Achieved environmental benefits

Reduced energy consumption. Fats in the waste water are easier to remove at lower temperatures.

Environmental performance and operational data

If hot water is provided by blending steam with cold water at the point of use, the water temperature is often controlled by manually adjusting the steam- and water-blending valves. Steam pressure and water pressure may vary throughout the day, so the temperature may also vary. To ensure that minimum temperature requirements, not necessarily required by law, for wash or rinse water are met, an operator may open steam valves enough so that the water always remains above a certain temperature. This leads to unnecessarily high temperatures when the steam pressure is high or the water pressure is low. If thermostatically controlled steam- and water-blending valves are used, they can automatically control the water temperature and remove the responsibility from the operator to judge the correct setting.

An energy savings calculation for lowering the water temperature for cleaning at one station by installing an automatically controlled steam- and water-blending valve is shown below.

This calculation assumes a starting water temperature of 100 °C and a flow rate of 83.3 l/min. The target cleaning water temperature is 60 °C. Gas is used in a steam boiler at a cost of USD 0.495/therm (i.e. USD 4.67/GJ). Assuming that the efficiency of the system is 70 % and the hose is used for 2 h/d, 250 d/yr, the calculated annual saving is USD 2 698 (costs in 2000).

Another example shows the energy and cost savings per hose from lowering the water temperature from 71 °C to various lower temperatures. The example assumes a water use of 831 l/min, 6 h/d for 250 d/yr. Some examples of the savings are shown in Table 2.7.

Table 2.7: Annual energy and cost savings per hose from lowering the water temperature from 71 °C to various lower temperatures

New temperature setting (°C)	Energy savings (GJ/yr)	Cost savings using natural gas (USD)
68.3	7 793	580
60	31 160	2 340
51.9	54 528	4 090
46.1	70 104	5 260
32.2	10 9057	8 174

NB: Cost of natural gas - USD 0.175/m³ in 2000.
 Source: [72, Ockerman H.W. and Hansen C.L. 2000]

Cross-media effects

None.

Technical considerations relevant to applicability

Applicable in all SA installations.

Economics

The valves are reported to cost USD 450-700 (costs in 2000) and the payback period depends on the previous water temperature settings and the variation of the temperature above those settings.

Driving force for implementation

Reduced energy costs.

Example plants

This technique has been reported in approximately 20 % of the installations participating in the SA data collection [178, TWG 2020].

Reference literature

[72, Ockerman H.W. and Hansen C.L. 2000], [178, TWG 2020].

2.3.4.3 Techniques related to compressed air**2.3.4.3.1 Reduction of compressed air system leaks**

For more information, consult reduction of air leaks and optimisation of pressure settings in the FDM BREF [121, Giner-Santonja et al. 2019].

Description

Carrying out of leak prevention measures and periodic leak tests, and setting the pressure at the compressor at the maximum required and then regulating it at each individual application.

Technical description

Consumption losses during production downtime can be avoided by sectorisation of pressure (multiple changes to the pressure distribution). Several additional techniques can be implemented to optimise compressed air generation and use, including:

- replacing pneumatic installations with electric ones;
- using a variable speed compressor;
- adjusting the pressure level (more pressure is provided with a separate compressor);
- adapting the compressor to the need (flow/pressure).

Achieved environmental benefits

Reduced energy consumption and reduced noise, if large compressors run for shorter periods.

Environmental performance and operational data

No information provided.

Technical considerations relevant to applicability

Generally, there are no technical restrictions to the applicability of this technique.

Economics

No information provided.

Driving force for implementation

Reduced energy costs.

Example plants

This technique has been reported in approximately 55 % of the installations participating in the SA data collection [178, TWG 2020].

Reference literature

[121, Giner-Santonja et al. 2019], [178, TWG 2020].

2.3.5 Techniques to reduce water consumption

2.3.5.1 Management, design and operation techniques

2.3.5.1.1 Water management plan and water audits

Description

A water management plan and water audits are part of the environmental management system (EMS) and include:

- flow diagrams and a water mass balance of the plant and processes as part of the inventory of inputs and outputs mentioned in Section 2.3.3.7;
- establishment of water efficiency objectives;
- implementation of water optimisation techniques (e.g. control of water usage, reuse/recycling, detection and repair of leaks).

Water audits are carried out at least annually to increase the reliability of controls and to ensure that the objectives of the water management plan are met. An audit checklist is generally used, which allows the targeting and prioritisation of the areas where the organisation can optimise water usage.

Achieved environmental benefits

Reduction of water consumption and waste water discharge.

Environmental performance and operational data

No information provided.

Cross-media effects

None reported.

Technical considerations relevant to applicability

The level of detail and nature of the water management plan and water audits will generally be related to the nature, scale and complexity of the plant.

Economics

- Staff time.
- Cost of any additional metering required.

Driving force for implementation

Cost reduction depending on pricing and availability of water.

Example plants

Frequently used in SA installations.

Reference literature

[193, Chronopoulos et al. 2020].

2.3.5.1.2 Water reuse and/or recycling

Description

Recycling and/or reuse of water streams (preceded or not by water treatment), e.g. for cleaning, washing, cooling or for the process itself.

Technical description

Recycling/reuse of water can be carried out either preceded or not preceded by water treatment. Examples are given for both options under Environmental performance and operational data below.

Achieved environmental benefits

- Reduction of water consumption (e.g. water of drinking water quality) by using water fit for purpose, from sources of a different quality.
- Reduction of emissions to water.
- The technique can also enable heat to be recovered (e.g. condensate return).

Environmental performance and operational data

There are multiple ways of reusing water reported in the questionnaires of the SA BREF data collection. Some examples are as follows:

- Use of cooling water and water from vacuum pumps: Water from cooling systems, which has not previously been in contact with the products, by-products or other substances and which is of drinking water quality, can be used in some applications.
- Reuse of purified water after membrane filtration, ultrafiltration and reverse osmosis, as well as UV-light treatment. The reverse osmosis concentrate may be reused in agriculture.
- Recirculation of water within pig de-hairing machines (applicable in pig slaughterhouses, see Section 3.3.4.2.2).
- Reuse of cooling water from the singeing kiln (applicable in pig slaughterhouses, see Section 3.3.4.2.3).
- Reuse of crate washing water (applicable in poultry slaughterhouses, see Section 3.4.3.3.1).
- Use of recycled water, from scalding, for the transfer of feathers (applicable in poultry slaughterhouses, see Section 3.4.3.3.2).

Cross-media effects

An increase in recycling/reuse of water can result in an increase in energy and chemical consumption for treatment of water before recycling.

Technical considerations relevant to applicability

Water recycling/reuse opportunities are present in existing and new SA installations. Hygiene and safety requirements may compromise the applicability of this technique.

Economics

No information provided.

Driving force for implementation

Reduced water consumption.

Example plants

Water recycling/reuse is commonly reported in the SA sector.

Reference literature

[121, Giner-Santonja et al. 2019], [204, TWG 2021].

2.3.5.1.3 Optimisation of water flow**Description**

Use of various control devices, e.g. photocells, flow valves, thermostatic valves, to automatically adjust the water flow to the minimum amount needed.

Technical description

Flow measurement and control techniques can reduce water consumption and waste water generation in SA processing.

For example in slaughterhouses, sensors such as photocells can be fitted to detect carcasses and parts of carcasses and to supply water as required (see Section 3.2.3.2.1.2). The water supply can be turned off automatically between carcasses and during all breaks.

Moreover, in slaughterhouses, the periodic change of water in electrically heated knife sterilisers can be controlled by a timer (see Section 3.2.3.2.1.6).

In pig slaughterhouses, the water level control in the pig scalding tank can be controlled (see Section 3.3.4.2.4).

Another example of automation is related to cooling towers. Blowdown may be controlled by measurement of conductivity to detect when it is required.

Achieved environmental benefits

Reduced water consumption and associated energy use.

Environmental performance and operational data

In relation to the moving of intestines, water may be supplied to slides, intestine conveyors and intestine elevators, only when required. The required water quantity can be determined and the setting can then be locked.

Moreover, water usage can be minimised during rinsing of tongues and hearts. The rinsing of tongues, sweetbread and neck meat is sometimes done to remove blood splashes. Tongues can be rinsed without using running water. A timer control can be fitted to the water supply, to ensure that water is used in the required time only, or with intervals. Tongues can also be hung on a Christmas tree (multiple hook) or placed in a trolley with perforations and then rinsed lightly before being stored in a chill room. The rinsing of hearts can be done with a handheld showerhead after hanging them on a rack. It can be limited to only rinsing away possible blood drips.

Cross-media effects

There are no cross-media effects associated with this technique.

Technical considerations relevant to applicability

Generally applicable.

Driving force for implementation

Reduced water consumption and associated costs.

Example plants

Widely applied in the SA sector.

Reference literature

[121, Giner-Santonja et al. 2019].

2.3.5.1.4 Optimisation and appropriate use of water nozzles and hoses

Description

Use of the correct number and position of nozzles; adjustment of the water pressure of nozzles and hoses.

Technical description

Where a supply of water is essential, e.g. to a slaughter-line, it can be supplied through nozzles designed and positioned for each individual unit operation and cleaning operation. For cleaning operations, the water may be supplied to a series of hoses, e.g. a ring main. The water flow at each nozzle can be set by the management, for each individual application. The water pressure can be adjusted according to the unit operation/cleaning operation requiring the highest pressure and a suitable pressure regulator can be installed at each of the other unit operations/cleaning stations which require water.

Water nozzles are widely used in the SA sector, e.g. for washing and for and cleaning the equipment during processing. Water consumption and waste water pollution minimisation can be carried out by correctly positioning and directing the nozzles.

In addition, water consumption can be optimised by monitoring and maintaining the water pressure of the water nozzles. Water pressure can be adjusted according to the unit operation requiring the highest pressure and a suitable pressure regulator can be installed at each of the other unit operations which require water.

A nozzle can be fitted with two mixing chambers. The first chamber has a conical shape where water is mixed with compressed air. This results in a very small droplet size. In the second chamber, the droplet/air mixture is expelled at very high speed, due to the pressure differential, through the mouth of the nozzle [184, IWC 2020].

Achieved environmental benefits

Reduced water consumption and waste water generation. Reduced waste water pollution, e.g. due to the reduction of the contact time between the food and water.

Environmental performance and operational data

Some examples of use and optimisation of nozzles in the SA sector are presented below:

Replacement of irrigation pipes with flat jet nozzles

All irrigation pipes can be replaced with flat jet nozzles, which have considerably lower water consumption. Nozzles with diameters below 2 mm block frequently. In some installations it may be necessary to install a pressuriser to increase the water pressure. As an example, the water consumption for rind treatment has been reduced from approximately 100 litres per pig to 20-25 litres per pig (from 1 300 l/t to 260-325 l/t carcass) as a result of this and other techniques.

Saw sterilisation in a cabinet with automated hot water nozzles

Chest-opening saws can be sterilised in a cabinet with nozzles supplying water at 82 °C, instead of in running water in a vat at the same temperature. The water supply can be turned on and off, as required. Reduced water consumption, by 130-195 l/t carcass, has been reported

Use of nozzles instead of showers to flush out large intestines

When large intestines are flushed out, showers or nozzles are used to wet the surfaces to ensure that the intestines slide easily and are not damaged. Showerheads can be replaced by nozzles. Reduced water consumption, from 3.8 litres per pig intestine with a shower running continuously to 1.0 litre per pig intestine with a nozzle running only when the pipe is activated, has been reported.

Use of spray nozzles in an evisceration line (poultry slaughterhouse)

An evisceration line with a total of 32 showerheads has a reported water use of approximately 600 l/h. Changing from domestic-style showerheads, to an alternative form of spray nozzle, e.g. orifice plates, which have an estimated flow rate of 500 l/h, can save water. Additional savings may be achieved on new lines by reducing the number of showerheads.

Showering of pigs, using water-saving, timer-controlled nozzles

Pigs are showered during hot, dry periods, for animal welfare reasons. It helps to calm them and to prevent them from becoming stressed. The shower nozzles can be designed and installed so that they are only activated when there are pigs present. The flow and the operation time are controlled automatically. Showering also improves the environment for people entering the lairage, by reducing respirable and total dust levels.

Replacement of irrigation pipes at the top of de-hairing machines, with nozzles

In pig slaughterhouses, the irrigation pipes at the top of the de-hairer can be replaced with flat jet nozzles, which direct the flow of water at the pigs. At the same time, the spray to transport the hair away can be moved to just under the pig, because the water in this area will no longer be sufficient by itself, for removing the hair. The water can be controlled so that it is only running when there is a pig in the machine. It is unnecessary to add water to the gambrelling table. The water use can be reduced from 16 litres per pig to 6 litres per pig (208 l/t carcass to 78 l/t carcass).

Control of water consumption for small and large intestine washing with the use of nozzles

The water supply for the small and large intestine lines can be strictly regulated and valves can be equipped with nozzles and automatic stop controls. Water consumption in a pig slaughterhouse has reportedly been reduced from 70 litres to 40 litres per gut set. On the small intestine line in a Danish pig slaughterhouse, water savings of 844 l/t carcass have been reported.

Post-singeing showering with flat jet nozzles

In pig slaughterhouses, showering can be done with flat jet nozzles instead of showerheads. The water supply can be arranged so that water only flows when a carcass is present. The water consumption can be reduced from 3 000-4 000 l/h to approximately 400 l/h, depending on the throughput of carcasses per hour.

Use of nozzles instead of irrigation pipes for defeathering

It is possible to use nozzles instead of irrigation pipes to supply water in the defeathering machine. They can also be used, supplemented with beater straps, for showering poultry after defeathering.

Cross-media effects

There are no cross-media effects associated with this technique.

Technical considerations relevant to applicability

Generally applicable.

Economics

The payback time for replacing showerheads with nozzles has been calculated to be approximately 6 months.

Driving force for implementation

Reduction of costs associated with savings in water consumption.

Example plants

Widely applied in the SA sector.

Reference literature

[23, Nordic 2001], [81, Brindle J. 2002], [49, AVEC 2001], [108, Clitravi - DMRI 2003], [121, Giner-Santonja et al. 2019], [184, IWC 2020].

2.3.5.1.5 Segregation of water streams

Description

Water streams that do not need treatment (e.g. uncontaminated cooling water, uncontaminated run-off water) are segregated from waste water that has to undergo treatment, thus enabling uncontaminated water recycling.

Technical description

The drainage/sewerage system can be designed to separate waste water into different categories, to collect as much waste as possible and to treat the waste correctly. This technique should complement others which minimise the amount of materials entering the waste water and thus can help to optimise the reuse of water.

Rainwater and cooling water from the refrigeration system can be discharged in the same system, as they are usually not contaminated.

Waste water from lairage and from the cleaning of lorries can be collected in a second system, as it usually contains manure. Filtered material from this system can be used for biogas production or composting.

The waste water from the production and the casing department could be channelled separately. The treatment which the entrained material will have to undergo will depend on the Category assigned to it under the ABP Regulation (Regulation (EC) No 1069/2009).

Achieved environmental benefits

Reduced water contamination, by keeping clean water separate from dirty water, and consequently also a reduced energy consumption associated with the waste water treatment.

Environmental performance and operational data

No information provided.

Cross-media effects

None.

Technical considerations relevant to applicability

Applicability to existing plants may be restricted by the layout of the water collection system and a lack of space for temporary storage tanks.

Economics

High capital cost; however, this may be offset by the reduced running costs due to the lower requirement for waste water treatment, whether on site, at municipal WWTPs or a combination of both.

Driving force for implementation

Reduction of long-term expenses for treating waste water and disposing of animal waste.

Example plants

Several animal by-products plants in Germany. Pig slaughterhouses in Denmark [118, Denmark 2015].

References to literature

[23, Nordic 2001], [37, Pontoppidan O. 2001], [62, Germany 2002], [118, Denmark 2015], [121, Giner-Santonja et al. 2019].

2.3.5.1.6 Dry transport of by-products

Description

By-products and waste from the slaughter and animal by-products treatment processes are transported as dry as possible.

Technical description

By-products and waste from the slaughter and animal by-products treatment processes can be transported as dry as possible and all spillages cleaned up, by sweeping or by using a squeegee, prior to wet cleaning. This reduces the entrainment of organic matter into water, which would consequently have to be treated in either an on-site or municipal waste water treatment plant.

Achieved environmental benefits

Reduced water consumption and volume of waste water. Reduced entrainment of materials in waste water and, therefore, reduced COD and BOD levels. Increased potential for the recovery and recycling of substances generated in the process. Reduced use of energy needed to heat water. Reduced use of detergents.

Environmental performance and operational data

Some examples of dry transport methods include the transfer of feathers by screw conveyer and the transfer of offal not intended for human consumption by vacuum or compressed air. Transport in water is usually appropriate for by-products intended for human consumption, partly because of the cooling effect, although this still needs to be assessed on a case-by-case basis, because alternatively frequent despatch of batches, to cooled areas, may remove the need for such water consumption and the associated contamination.

Cross-media effects

None.

Technical considerations relevant to applicability

Applicable in all SA installations.

Driving force for implementation

Reduced energy and water use, reduced need for waste water treatment and lower detergent use and expenditure.

Example plants

Several rendering plants in Germany.

Reference literature

[31, Greek Ministry for the Environment 2001], [62, Germany 2002], [105, Belgium 2003].

2.3.5.2 Techniques related to cleaning

2.3.5.2.1 Dry cleaning

Description

Removal of as much residual material as possible from raw materials and equipment before they are cleaned with liquids, e.g. by using compressed air, vacuum systems or catchpots with a mesh cover.

Technical description

As much residual material as possible can be removed from raw materials, vessels and equipment before they are wet cleaned. This can be applied both during and at the end of the working period. All spillages can be cleaned up, by for example shovelling or vacuuming spilt material or by using a squeegee, prior to wet cleaning, rather than hosing them down the drain. This reduces the

entrainment of material into water, which would consequently have to be treated in a WWTP. This is enhanced further by transporting materials such as ingredients, by-products and waste from processing as dry as possible.

Dry cleaning is facilitated by, for example, providing and using catchpots with a mesh cover, making sure suitable dry clean-up equipment is always readily available and providing convenient, secure receptacles for the collected waste (see Section 2.3.2.2). Catchpots may be locked in place to ensure that they are in position during cleaning. As well as manual dry cleaning of equipment and installations, other measures can be used, such as letting materials drain naturally, by gravity, into suitably located receptacles and by using pigging.

Dry cleaning can also be applied by [118, Denmark 2015]:

- using a rubber scraper to clean the blood line; it is only after a thorough scraping that cleaning with water begins;
- scraping transportation vehicles for live animals before cleaning with water.

Cleaning of the lairage in slaughterhouses can be done by collecting manure and bedding materials, before rinsing with water. In cases where the drains are connected to a urine/slurry container, they can be transferred to the sewerage system before rinsing starts to prevent overloading of the container. Cleaning with dry scraping, using a squeegee and a shovel, is normally sufficient, although it should be followed by high-pressure rinsing at least once a week.

Moreover in slaughterhouses, manure and bedding can be scraped into a collection area before delivery vehicles are cleaned with water. The wash area is arranged so that as much manure as possible can be collected before the vehicle wash starts.

Achieved environmental benefits

- Reduced water consumption and volume of waste water.
- Reduced entrainment of materials in waste water and therefore reduced COD and BOD levels.
- Increased potential for the recovery and recycling of substances generated in the process.
- Reduced use of energy needed to heat water.
- Reduced use of detergents.

Environmental performance and operational data

Immediate removal may be necessary to safeguard hygiene and prevent microbiological risks.

In pig slaughterhouses using dry scraping, water consumption levels of 78-130 litres per tonne of pig carcass have been reported, compared to a maximum level of 300 litres elsewhere. At one major pig slaughterhouse in Denmark, the water consumption for cleaning vehicles is approximately 110 l/t, when using dry scraping. The time for the driver to carry out dry scraping followed by washing is practically the same as when washing only is carried out.

Cross-media effects

Increased solid waste.

Technical considerations relevant to applicability

Generally applicable.

Driving force for implementation

- Reduced energy and water use.
- Reduced need for waste water treatment.
- Lower detergent use and expenditure.

Example plants

Many installations apply some dry cleaning prior to wet cleaning.

Reference literature

[23, Nordic 2001], [118, Denmark 2015], [121, Giner-Santonja et al. 2019].

2.3.5.2.2 High-pressure cleaning

Description

Spraying of cleaning water at pressures ranging from 15 bar to 150 bar.

Technical description

In high-pressure cleaning, water is sprayed onto the surface to be cleaned at pressures ranging from 15 bar, which is considered to be low pressure, up to 150 bar, which is considered to be high pressure. A pressure of about 40-65 bar has also been described as high.

Cleaning agents are injected into the water, at moderate temperatures of up to 60 °C. An important part of the cleaning action is due to mechanical effects. Pressure cleaning reduces water and chemical consumption compared with mains hoses. It is important, however, that a pressure that is both safe and efficient is used. There is concern in the food industry about the hygiene implications of over-splash and aerosols associated with the use of high-pressure hoses.

High- and medium-pressure cleaners have the following advantages compared with low-pressure cleaners: water use is lower due to the mechanical cleaning action of the water jet; chemical use is lower because heavy soiling is removed by the action of the water jet and the reduction in water volume means that there is less of a breeding ground for bacteria. However, there may be concerns about the increased aerosol risks with higher water pressures.

Pressurised water can be used to wash the carcasses. If the pressure is kept below 1 MPa, this will reportedly avoid fat detachment and the consequent waste water contamination. A mixture of compressed air and water increases the pressure without using excess water.

Moreover, delivery lorries can be cleaned using a high-pressure trigger-operated adjustable water jet.

Achieved environmental benefits

A 75 % reduction in water consumption can be achieved. Consequently, the volume of waste water to be treated is also reduced. Also if the water used is heated, then there is an energy saving too.

Environmental performance and operational data

Notwithstanding the effects of temperature and cleaning agents for example, the effectiveness of cleaning using hoses varies depending on the flow of the water and the applied pressure. It has been reported that a pressure of 1.5 MPa and a flow of 60 l/min per nozzle gives a good result for cleaning trucks, compared to 0.3 MPa (3 bar) and 250 l/min, i.e. a 75 % water saving is possible for the same cleaning result.

The use of an adjustable high-pressure water pistol with a pressure of approximately 1.8-2.3 million Pa (18-25 atmospheres) can reportedly reduce the water consumption needed for washing lorries. The step-less control of the pressure and the range of the water jet makes it possible to remove dirt from both flat surfaces and corners. A saving of 130 l/t of carcass can be achieved due to the fact that the water flow stops when the trigger is released.

Cross-media effects

None foreseen.

Technical considerations relevant to applicability

May not be applicable due to health and safety requirements.

Economics

The direct economic benefit depends on the price of the water. If the existing pumps and water pipes are not fit for the desired pressure, then their replacement will increase the investment costs.

The cost of a pump system with two hoses was reported to be approximately DKK 35 000 (2001). In the case of increasing the water pressure before the pressure gun could be used, the reported cost was EUR 10 000-14 000. This reportedly covered the cost of installing high-pressure pumps for the cleaning of several lorries, normally four, at a time. It also included, amongst other things, piping and electrical works, hoses and spray guns.

Driving force for implementation

Saving water and, therefore money.

Reference literature

[1, EPA 1996], [59, The Netherlands 2002], [23, Nordic 2001], [37, Pontoppidan O. 2001], [121, Giner-Santonja et al. 2019].

2.3.5.2.3 Optimisation of chemical dosing and water use in cleaning-in-place (CIP)**Description**

The amounts of hot water and chemicals used are optimised by measuring for example turbidity, conductivity, temperature and/or pH.

Technical description

CIP systems are cleaning systems that are incorporated into equipment and can be set to use only the required quantities of detergents and water at the correct temperature (and sometimes pressure) conditions for that equipment and the substance it is being used for. Incorporation of a CIP system can be considered at the equipment design stage and installed by the manufacturer. Retrofitting a CIP system may be possible, but is potentially more difficult and expensive. CIP systems can be improved by incorporating the internal recycling of water and chemicals, optimising programmes, using water-efficient spray devices and by removing product and gross soiling prior to cleaning. Equipment correctly designed for CIP cleaning should have spray balls located so that there are no 'blind spots' in the cleaning process.

Design and operational features which increase the efficiency of the CIP system include:

- using a turbidity or conductivity detector to optimise both the recovery of material/product from water and the reuse of cleaning water during pre-rinsing;
- measuring pH to optimise chemical consumption.

Additional features to optimise CIP include the following:

- Dry product removal before the start of the wet cleaning cycle by, for example, gravity draining, pigging or using compressed air.
- Pre-rinsing using small quantities of water, which, in some circumstances, may be combined with either returning the pre-rinse water to the process for reuse or recovering it for disposal.
- Internal recycling of water and chemicals.
- Water-efficient spray devices.
- Correct selection of CIP detergents.
- Collection and reuse of CIP detergents: instead of discharging to waste water after each CIP, the detergents are collected in tanks to be reused; new detergent is fed continuously until the correct concentration is reached.

- Regeneration of caustic soda used in CIP. The pipes and tanks are flushed through with hot alkali as a first step, resulting in a liquid very high in organic matter. The used caustic soda is then passed through a process in which a clay-based reagent is used to separate the alkali from the solids which form a sludge.

It is common practice for the final rinse water to be reused, either for pre-rinsing, intermediate rinsing or the preparation of cleaning solutions. The aim of the final rinse is to remove the last traces of cleaning solutions from the cleaned equipment. Clean water is used and the rinsing water, which returns to the central CIP unit, is clean enough to be reused, instead of being discharged to the drain. The recovery of the final rinsing water requires a connection from the CIP return pipe to the pre-rinsing tank. A conductivity transmitter is used to divert the water, e.g. to the pre-rinsing tank.

Achieved environmental benefits

A reduction in the consumption of water, detergents and the energy needed to heat the water are achievable because it is possible to set the consumption levels, specifying the use of only that required for the surface area to be cleaned. It is possible to recover and reuse water and chemicals within the system.

Cross-media effects

Possible energy considerations associated with pumping the water and detergent.

Technical considerations relevant to applicability

Applicable in closed/sealed equipment through which liquids can be circulated, comprising for example pipes and vessels.

Economics

The capital cost can be high but annual savings due to reduced hot water and chemical consumption are achieved.

Driving force for implementation

Automation and ease of operation. Reduced requirement to dismantle and reassemble equipment.

Example plant

Commonly used in the SA sector.

Reference literature

[10, ETBPP 1998], [23, Nordic 2001], [29, Germany 2001], [121, Giner-Santonja et al. 2019].

2.3.5.2.4 Low-pressure foam and/or gel cleaning

Description

Use of low-pressure foam and/or gel instead of water to clean walls, floors and/or equipment surfaces.

Technical description

Low-pressure foam cleaning can be used instead of traditional manual cleaning with water hoses, brushes and manually dosed detergents. It can be used to clean walls, floors and equipment surfaces. A foam cleaner, such as an alkaline solution, is sprayed onto the surface to be cleaned. The foam adheres to the surface. It is left for about 10-20 minutes and is then rinsed away with water.

Low-pressure foam cleaning can either use a centralised ring main or decentralised individual units. Centralised systems supply pre-mixed cleaning solutions and pressurised water from a central unit and during cleaning they automatically change between foam spreading and rinsing.

Achieved environmental benefits

Reduced water, chemical and energy consumption compared to the use of traditional water hoses, brushes and manually dosed detergents.

Environmental performance and operational data

Cleaning with gels provides a longer contact time between the soiling and active detergent than foams, because of the tenacious nature of gels with surfaces, and there is greater accessibility to crevices as access is not inhibited by air bubbles. However, gels are transparent and difficult to see and may be inconsistent at high temperatures.

Reported advantages of using gels include increased contact time with soiled surfaces, which allows improved cleaning results to be achieved, even though less aggressive chemicals are used. The chemical constituents soften soiling, resulting in improved rinsing efficiency and cleaning. As gels are very easy to rinse, less water is used. Labour costs are also reduced because, compared with traditional methods, cleaning takes less time. Due to less aggressive chemicals being used, there is reduced wear and tear on machinery and reduced risk to the operator.

Gels are typically used for cleaning walls, ceilings, floors, equipment and containers. The chemical is sprayed onto the surface to be cleaned.

Technical considerations relevant to applicability

Applicable in new and existing installations, for cleaning floors, walls, vessels, containers, open equipment and conveyors.

Economics

No information provided.

Driving force for implementation

Better cleaning and the elimination of problems associated with high-pressure cleaning, e.g. spreading of aerosols containing dirt particles and bacteria.

Example plant

Commonly used in the SA sector.

Reference literature

[121, Giner-Santonja et al. 2019].

2.3.5.2.5 Optimised design and construction of equipment and process areas**Description**

The equipment and process areas are designed and constructed in a way that facilitates cleaning. When optimising the design and construction, hygiene requirements are taken into account.

Technical description

Hygienic design is a set of design and construction criteria that improve the cleanability of equipment and facilities, by avoiding critical points and dead zones where the product may be retained and cannot be removed properly using standard sanitation (cleaning and/or disinfection). The prefix 'eco' refers to additional design criteria intended to reduce the environmental impact during sanitation (i.e. spillage collection, reduction of pipelines, reuse of cleaning water in closed loops, etc.)

The main goal of hygienic design of equipment and facilities is hygiene, but it is also related to the reduction of the environmental impact of cleaning and disinfecting operations, requiring a lower input of water, energy and chemicals to achieve the same level of hygiene. In other words, from the hygienic point of view, equipment and premises are hygienically designed and constructed if they minimise the risk of contamination of food being processed.

From the environmental point of view, hygienically designed and constructed equipment and premises reduce the environmental impact of their sanitation. Eco-hygienic design of equipment and installations is presented as a preventive technique to reduce the environmental impact of sanitation of food production equipment while maintaining the hygienic results of sanitation.

At the global level, there are two recognised groups working on hygienic design criteria and standards:

- The European Hygienic Engineering & Design Group (EHEDG) has published several guidelines for hygienic design criteria that have become a reference for both equipment manufacturers and the food industry. These guidelines are online and are regularly updated and complemented by new documents in various languages.
- 3-A SSI is an independent US corporation dedicated to education and the mission to promote food safety through hygienic equipment design in the food, beverage and pharmaceutical industries (<http://www.techstreet.com/3a>).

All vehicles, handling and storage equipment and premises can be smooth, impervious and designed so as not to harbour solids and liquids. Floors can have a chemical-resistant finish applied, to prevent damage being caused by the chemicals used for cleaning and disinfection. Floors can be sloped to holding pits.

Achieved environmental benefits

- Reduction in the consumption of water and its contamination by cleaning chemicals.
- Reduced odour emissions.

Environmental performance and operational data

Vehicles and equipment can be designed in such a way that eases the movement and removal of materials, e.g. by ensuring that hoppers have sides which slope downwards, by avoiding angles where materials may stick or be difficult to dislodge and by ensuring that none of the equipment contains any 'dead ends'.

Cross-media effects

The construction phase of some eco-hygienically designed equipment could potentially entail an increase in material, energy or water use compared to construction of conventional equipment (i.e. extra polishing in order to reduce the roughness of the surface). However, any extra consumption required would be clearly negligible in comparison to the consumption of the near daily sanitation over the total life cycle of food processing equipment (lifetime 10-20 years).

Technical considerations relevant to applicability

Applicable in all SA installations.

Economics

The increase in the market price of eco-hygienic certified equipment (with EHEDG certification) compared to their conventional equivalents could be below 5 %.

Driving force for implementation

Reduction of costs associated with savings in water and energy consumption. Ease of operation, including cleaning. Reduced odour emissions.

Example plants

Commonly used in the SA sector.

Reference literature

[3, Environment Agency 1997], [12, Environment Agency 1996]
[121, Giner-Santonja et al. 2019].

2.3.5.2.6 Fitting of cleaning hoses with hand-operated triggers

Description

Fitting of cleaning hoses with hand-operated triggers.

Technical description

Trigger-control shutoffs can be fitted to cleaning hoses with no other modification, if a water heater is used to provide hot water. If a steam- and water-blending valve is used to provide hot water, it will be necessary to install check valves to prevent steam or water from entering the wrong line. Automatic shutoff valves are often sold with nozzles attached. Nozzles increase the water impact and decrease flow.

Achieved environmental benefits

Reduced water and energy consumption.

Environmental performance and operational data

The energy saved was calculated for running a hose that had been fitted with an automatic shutoff valve and nozzle, using water at a temperature of 71 °C. The flow rate before installation was 76 l/min and after installation was 57 l/min. The time the hose was running was 8 h/d before installation and 4 h/d afterwards. For a water cost of USD 0.21/m³, an annual water cost saving of USD 4 987 (costs in 2000) was calculated. An annual energy saving of 919 GJ has also been calculated.

Cross-media effects

None.

Technical considerations relevant to applicability

Applicable in all SA installations.

Economics

If nozzles are installed without automatic shutoffs, the equipment costs are less than USD 10. An automatic trigger-controlled shutoff with a nozzle costs approximately USD 90. (Costs in 2000.) The payback is reported to be immediate.

Driving force for implementation

Reduced water and energy costs.

Example plants

A turkey slaughterhouse in the UK.

Reference literature

[1, EPA 1996], [49, AVEC 2001], [72, Ockerman H.W. and Hansen C.L. 2000].

2.3.5.2.7 Prompt cleaning of equipment

Description

Cleaning is carried out as soon as possible after use of equipment to prevent hardening of residual material.

Technical description

For additional information, consult the Sectoral Reference Document on Best Environmental Management Practices for the food and beverage manufacturing sector [194, COM 2017].

Achieved environmental benefits

Reduced water consumption and waste water pollution.

Environmental performance and operational data

No information provided.

Cross-media effects

No information provided.

Technical considerations relevant to applicability

Applicable to all installations where manual cleaning is carried out.

Economics

No information provided.

Driving force for implementation

Reduced water and waste water treatment costs.

Example plants

This technique is widely applied in the SA sector.

Reference literature

[121, Giner-Santonja et al. 2019], [194, COM 2017].

2.3.6 Waste water treatment techniques

2.3.6.1 Preliminary, primary and general treatment

2.3.6.1.1 Screening of solids

Description

The use of a device with openings, generally of uniform size, to retain the coarse solids present in waste water.

Technical description

After solids are removed with process-integrated techniques and prevented from entering the waste water, e.g. using catchpots located at drainage points inside the installation, further solids can be removed from the waste water using screening. Large quantities of non-emulsified FOG can be removed if screening is carried out together with technical and operational measures to avoid clogging.

A screen is a device with openings, generally of uniform size, that is used to retain the coarse solids found in waste water. The screening element consists of parallel bars, rods or wires, grating or a wire mesh or perforated plate. The openings may be of any shape but are generally circular or rectangular slots. The spacing between bars for removing very coarse materials prior to finer screening may be 20-60 mm. To remove smaller particles, the spacing between bars generally does not exceed 5 mm. The openings in automatic screens range from 0.5 mm to 5 mm, with openings of 1-3 mm in widespread use. Smaller openings (1-1.5 mm) are reported to be less susceptible to blockage than larger ones (2-3 mm).

The most commonly used screening equipment at slaughterhouses includes the static wedge screen, inclined screw press and the rotary drum screen. These screens typically have a mesh size of about 3 mm. After screening, many large SA installations use a DAF treatment plant to further treat their waste water prior to discharge. DAF uses very fine air bubbles to remove suspended solids. The suspended solids float to the top of the liquid and form foam, which is then skimmed off.

In the static wedge/curved screen the waste water is pumped, or flows by gravity, to the top of the screen and then runs down a slide constructed from profile bars. The liquid drains through the

screen, with the solids being collected at the bottom for separate disposal. Some screens are vibrated to facilitate particle transport. Others have cleaning nozzles for rinsing the screen from the clean side. Curved screens are supplied with slots down to 0.25 mm.

The inclined screw press is basically a rotating screw, edged with brushes, which is located inside a cylindrical perforated screen. The whole assembly is then incorporated within a U-shaped trough. The waste water is pumped or flows by gravity into the bottom of the trough and is moved up the cylindrical screen by the action of the rotating screw. The force of gravity and the action of the screw causes liquid to be extracted through the screen and the remaining solids are discharged from the top of the unit.

Rotary or drum screens receive the waste water at one end and discharge the solids at the other. The liquid is passed outward through the screen to a receiving box for forward transfer. The screen is usually cleaned by a semi-continuous spray via external spray nozzles, which are inclined towards the solids discharge end. This type of screen is effective for streams containing a relatively high solids content. Microscreens mechanically separate solid particles from the waste water by means of microscopically fine fabrics. The most important operating parameter is the headloss, i.e. the loss of operating pressure, with the best separation results reported to be between 5 mbar and 10 mbar.

Achieved environmental benefits

- Reduced suspended solids and BOD/COD sent to the next treatment step or in the waste water discharged.
- Reduced likelihood of blockages of pumps and pipes (which, if prolonged, could lead to operational issues and abnormal odour levels).

Environmental performance and operational data

Reduction rates of 50-90 % for settleable solids and 10-40 % for BOD₅. A BOD₅ reduction between 17 % and 49 % has been reported for slaughterhouse waste water, when using a mesh size of 1 mm. It is reported that the performance can be improved significantly if the screen is operated efficiently and is kept clean.

If screening is not undertaken, solids get trapped in the WWTP network, where they then rot, emit odours and cause problems for complete treatment of the waste water. If sieves and collection vessels are not enclosed there may be problems associated with freezing during winter and with odour and vermin in summer.

Cross-media effects

Odour may be emitted from the screenings.

Technical considerations relevant to applicability

Applicable in all SA installations which produce waste water.

Economics

No information provided.

Driving force for implementation

Reduced waste water treatment requirements. Reduction of the volumes of sludge produced, which would otherwise require additional costs for disposal.

Example plants

Widely used in SA installations [113, Waxwender et al. 2016], [178, TWG 2020].

Reference literature

[29, Germany 2001], [62, Germany 2002], [113, Waxwender et al. 2016], [130, COM 2005], [121, Giner-Santonja et al. 2019], [178, TWG 2020], [204, TWG 2021].

2.3.6.1.2 Fat, oil and grease removal

Description

A fat trap (or oil separator) is a plumbing device designed to intercept most fat, oil and grease before they enter the waste water treatment.

Technical description

Fat traps can capture fat, oil and grease that have been allowed to enter the waste water, by slowing down the flow of the water through the trap, which comprises a tank. If the water is hot, it is allowed to cool. As the water cools, the fat, oil and grease separate out and float to the top of the trap. The cooler water continues to flow out of the trap to the WWTP, while baffles contain the accumulated fat, oil and grease. The fat, oil and grease may be treated in a rendering plant.

The removal of the fat reduces corrosion and sedimentation in the receiving waste water pipelines and WWTPs and reduces the load requiring treatment.

Achieved environmental benefits

Removal of fat, oil and grease from waste water.

Environmental performance and operational data

The size of the fat trap can vary depending on the amount of fat produced and on how often the fat trap is maintained. Fat traps may be located inside or outside the building. If they are located inside the building they tend to be smaller and they require more frequent maintenance. Traps that are located outside the building will operate differently in winter and summer and are more prone to clogging during cold weather.

If the separated fat remains in the fat trap for a long period it degrades and consequently its usability decreases and odour problems may occur during storage and processing, which can imply subsequent increased treatment costs. Automatic and continuous removal of the fats, using a scraper, can minimise these problems.

It is reported that at an example slaughterhouse, the waste water is fed into the tank via a vortex chamber. The lightweight fat, oil and grease particles go to the top of the tank and heavier material which cannot be diverted drops out of the bottom of the tank. The water phase then flows upwards via a submerged pipe and leaves the tank. The fat accumulated on the surface is then removed using a scraper, which guides it to a hopper and then into a storage tank. The sedimented material which accumulates in the bottom part of the tank can be removed by gravity or pump, either automatically or controlled.

It is reported that this enhanced type of mechanical fat separation guarantees on average a COD reduction of 50 % of the maximum possible COD reduction. The separation efficiency can be considerably increased if precipitants and coagulants are added. The process can be further enhanced by aeration. If a residence time of over 4 minutes is applied lighter materials are also retained in the sludge, reducing the settleable solids by up to 60 %.

Manual fat collection during the slaughter-line reduced 35 % of the organic load in waste water in installation ES120 [178, TWG 2020].

Cross-media effects

The correct sizing of chambers is critical to ensure proper separation and to avoid the danger of washout during high or abnormal flows. Flow diversion may be needed if inflows suffer large fluctuations. Ease of emptying and regular maintenance is essential to prevent odour problems.

Installing fat traps within processing areas can cause food safety problems. Excessively hot water can cause fats to carry through and may melt precollected fat, so it should be avoided. The baffle material and ease of cleaning need to be considered.

Odour can be a major problem, particularly during emptying.

Technical considerations relevant to applicability

Applicable in all SA installations.

Economics

The investment required is reportedly outweighed by the savings in waste water treatment costs and plant maintenance.

Driving force for implementation

Reduction in problems caused by fat in waste water pipelines and WWTPs and reduced loads requiring treatment.

Example plants

This technique is widely applied in SA installations.

Reference literature

[104, Brechtelsbauer P. 2003], [121, Giner-Santonja et al. 2019], [178, TWG 2020], [204, TWG 2021].

2.3.6.1.3 Equalisation

Description

Balancing of flows and pollutant loads by using tanks or other management techniques.

Technical description

Storage and mixing tanks can be installed to equalise the enormous variations in the volume flow and in the concentration of the waste water.

Achieved environmental benefits

Enables downstream treatment techniques to operate at the optimum efficiency for minimising contaminated discharges to local watercourses.

Environmental performance and operational data

The constant use of equalisation tanks, rather than their intermittent use when the flow rate exceeds a predetermined figure, is advantageous to the WWTP, since it ensures a more consistent effluent for treatment and minimises the problems that may otherwise be caused by shock loading, e.g. from cleaning chemicals which are used once a day. The effluent quality and thickening performance of secondary sedimentation tanks following biological treatment are reportedly improved through constant solids loading. It is reported that there are advantages to be gained from locating the equalisation tank after the primary treatment and before the biological treatment. If it is located before the primary settling tank, sufficient mixing must be provided to prevent the deposition of solids, concentration variations and odour problems. It is also reported that, as a general rule, equalisation should take place after any large particles (e.g. sand or grit) and fat have been removed from the waste water.

At one slaughterhouse, which reportedly successfully treats process water and rainwater, an equalisation tank is located after the rotary screening equipment and before a flotation tank, where fat is skimmed off and sand is removed from the bottom of the tank. Another slaughterhouse reports that it has an equalisation tank capable of holding 4 days' worth of liquid effluent. This can have advantages in terms of creating a homogeneous feed to the WWTP, but it can also lead to odour problems.

The tanks need to be stirred to minimise the formation of noxious and malodorous gases and aeration of the tanks can reduce this further. They may also need to be coated to protect the concrete from corrosion by fatty acids. The tanks should be cleaned at regular intervals to prevent

the build-up of solids and fat. The tanks should be agitated to prevent settlement of solids and potential overload of the WWTP.

Cross-media effects

None reported.

Technical considerations relevant to applicability

Applicable in all SA installations where the flow rate and content of the waste water varies and where this may have a detrimental effect on the other WWTP processes.

Economics

The cost of constructing and operating an equalisation tank needs to be compared with the cost savings associated with the smooth running of the downstream treatment techniques.

Driving force for implementation

To ensure a homogeneous feed to downstream WWTP processes.

Example plants

This technique is widely applied in SA installations [178, TWG 2020].

Reference literature

[29, Germany 2001], [51, Metcalf and Eddy 1991], [62, Germany 2002], [73, Italy 2002], [121, Giner-Santonja et al. 2019], [178, TWG 2020], [204, TWG 2021].

2.3.6.1.4 Buffer storage for waste water

Description

The appropriate buffer storage capacity is determined by a risk assessment (taking into account the nature of the pollutant(s), the effects of these pollutants on further waste water treatment, the receiving environment, the amount of waste water generated, etc.)

A buffer tank is typically designed for storing the amounts of waste water generated during several peak hours of operation.

The waste water from this buffer storage is discharged after appropriate measures are taken (e.g. monitoring, treatment, reuse).

Technical description

Emergency buffer tanks provide a buffer capacity beyond the one that equalisation tanks can normally handle. More detailed information on buffer storage is available in the CWW BREF [154, Brinkmann et al. 2016].

Achieved environmental benefits

Avoidance of uncontrolled and untreated discharges of waste water.

Environmental performance and operational data

Contingency measures can be provided to prevent accidental discharges from processes damaging the WWTP, due to receipt of a sudden high load. A buffer (or diversion) tank is typically designed for storing the amounts of waste water generated during several peak hours of operation. The waste water streams are monitored upstream of the WWTP so that they can be automatically sidetracked to the buffer system if necessary. The buffer tank is linked back to the equalisation tank (see Section 2.3.6.1.1) or primary treatment stage so that out-of-specification liquors can be gradually introduced back into the waste water stream. Alternatively, provision can be made to allow the disposal of the diversion tank contents off site. Buffer tanks are also applied where there is no separate drainage system for surface water and it could enter the on-site WWTP.

Cross-media effects

There are no cross-media effects associated with this technique.

Economics

Investment costs of EUR 150 000 have been reported for the installation of two buffer tanks (90 m³ each) including the measurement and control system [121, Giner-Santonja et al. 2019].

Driving force for implementation

Compliance with legal requirements to limit pollution to a receiving water body.

Technical considerations relevant to applicability

Lack of space and/or the layout of the waste water collection system in existing plants can limit the applicability.

Example plants

This technique is widely used in SA installations [178, TWG 2020].

Reference literature

[121, Giner-Santonja et al. 2019], [154, Brinkmann et al. 2016], [178, TWG 2020], [204, TWG 2021].

2.3.6.2 Physico-chemical treatment**2.3.6.2.1 Chemical oxidation (e.g. with ozone)****Description**

Chemical oxidation is the conversion of pollutants by chemical-oxidising agents other than oxygen/air or bacteria into similar but less harmful or hazardous compounds and/or to short-chained and more easily degradable or biodegradable organic components. Ozone (O₃) is one example of a chemical-oxidising agent applied.

Technical description

Since ozone is involved in the process, an ozone generator is part of the equipment, because ozone as an unstable compound cannot be stored or transported and has to be generated on site. After treatment, surplus ozone has to be eliminated, e.g. using a catalyst system based on manganese oxide.

Typical pollutants targeted are reducible dissolved non-biodegradable or inhibitory pollutants, e.g. AOX, antimicrobial-resistant bacteria. In the example plants (DE047 and DE048), the technique was mainly applied to deal with AOX and consists of a water-cooled tubular ozone generator with a vertical design, which is equipped with an electrode system. The PSU (power supply unit) consists of a medium-frequency converter, high-voltage transformer and control unit. The PSU produces the medium-frequency high voltage (1-1 000 Hz) required for ozone generation from the mains voltage fed in (3 x 400 V/50 Hz).

The heat loss resulting from ozone formation is very efficiently dissipated to the cooling water via the heat exchanger designed as a tube bundle.

The internal structure of ozone generators achieves the production of ozone from oxygen-containing gases according to the principle of ‘silent electrical discharge’ or non-thermal plasma. The ozone generation system is characterised by the exclusive use of inert materials such as stainless steel, borosilicate glass and polytetrafluoroethylene (PTFE), which ensure the long service life and insensitivity of the core component of the ozone generator.

The technique can be used in cases where waste water contains compounds that are biologically difficult to break down.

Achieved environmental benefits

Reduction in AOX and COD emission levels.

Environmental performance and operational data

High ozone requirement of 8-15 g ozone per g of COD eliminated. A COD reduction of 3 mg/l for an ozone dosage of 40 g/m³ of waste water is expected.

The AOX removal is strongly dependent on the composition of the cleaning chemicals used as well as the respective waste water composition.

Cross-media effects

Electricity consumption.

Technical considerations relevant to applicability

No technical considerations reported.

Economics

For the purpose of AOX reduction, the technique is considered a more economic option than the application of activated carbon.

Driving force for implementation

Compliance with legal requirements to limit pollution to a receiving water body.

Example plants

Plants DE047 and DE048.

Reference literature

[178, TWG 2020].

2.3.6.2.2 Precipitation

See Section 2.3.6.5.1.

2.3.6.3 Secondary treatment

2.3.6.3.1 Aerobic treatment

2.3.6.3.1.1 Activated sludge process

Description

A biological process where the microorganisms are maintained in suspension in the waste water and the whole mixture is mechanically aerated. The activated sludge mixture is sent to a separation facility from where the sludge is recycled to the aeration tank.

Technical description

The activated sludge technique produces an activated mass of microorganisms capable of degrading waste aerobically. The general arrangement of an activated sludge process for removing carbonaceous matter includes the following items:

- Aeration tank where air (or oxygen or a combination of the two) is injected into the mixed liquor.
- Settling tank (usually referred to as the final clarifier or secondary settling tank) to allow the biological flocs to settle, thus separating the biological sludge from the clear treated water. The sludge is then recycled back to the aeration tank.

Treatment of nitrogenous matter involves additional steps where the mixed liquor is left in an anoxic condition.

Achieved environmental benefits

Reduction in BOD, TOC or COD, phosphorus and nitrogen emission levels.

Environmental performance and operational data

After a given residence time, which can vary from several hours to in excess of 10 days, based on an organic loading rate or F/M ratio of about 0.1-0.15 kg BOD/kg of MLSS per day, the mixed suspension of microorganisms is passed to a sedimentation facility (see Section 2.3.6.5.2). The hydraulic retention time or sludge age and F/M ratio can all vary as a function of the raw waste water characteristics, e.g. composition, availability and degradability of organic substances, and the required final waste water quality. For example, nitrification occurs with lower (< 0.1 kg BOD/kg of MLSS per day) F/M ratios. A removal efficiency of more than 85 % for COD and nitrogen can be observed in aerobic treatment.

Cross-media effects

These include high energy consumption for aeration combined with mixing in the aeration tank. Volatile waste water content can be released into the atmosphere, giving rise to odour. Aerobic biological treatment produces a relatively large amount of excess activated sludge that needs to be disposed of.

Technical considerations relevant to applicability

The technique can be used to treat high- or low-BOD waste water, but will treat low-BOD water highly efficiently and cost-effectively.

Economics

The activated sludge technique provides a cost-effective treatment of soluble organic matter.

Driving force for implementation

Compliance with legal requirements to limit pollution to a receiving water body.

Example plants

This technique is widely used in SA installations.

Reference literature

[121, Giner-Santonja et al. 2019] [204, TWG 2021].

2.3.6.3.1.2 Sequencing batch reactors

Description

The various stages of the activated sludge processes are all carried out within the same reactor.

Technical description

The sequencing batch reactor (SBR) process is an activated sludge process which treats waste water through a timed sequence of operations within one or more reactor tanks. The system allows equalisation, COD removal, nutrient removal and clarification to be achieved using a SBR. The cycle comprises a timed sequence of operations and is divided into the following main stages: filling, reaction, settling, discharging and idle.

Filling stage: the SBR is filled with a quantity of waste water. The filling can be static, aerated, anoxic and/or anaerobic and adjusted to the particular waste water by simply modifying parameters in the control unit. This adaptability reportedly improves nutrient removal and prevents bulking problems. The filling velocity can also be controlled and this affects the effectiveness of the final settling stage.

Reaction stage: the reactor is mixed and aerated in sequence to optimise the final removal of COD and nitrogen. These can be controlled with dissolved oxygen or oxidation-reduction potential monitoring to ensure the desired efficiency with the minimum consumption.

Settling stage: the biomass is separated from the treated water by sedimentation in the reactor. The clarification is very effective since there is no countercurrent flow of the treated water. The length of the sedimentation period can be modified during operation to improve the clarification.

Discharging stage: the treated clarified liquid is discharged by a floating device at an appropriate height to ensure that neither settled solids nor floating debris are discharged. Finally, the settled biomass is pumped away from the bottom of the reactor, to prevent a build-up of excess sludge.

Idle stage: when there is no waste water to be treated, the SBR is switched to an idle phase. During this stage, it is not necessary to run the aeration systems at the same rate as during a normal cycle.

Another technique has been reported which is similar and which uses separate reactor vessels for aerobic, anoxic and anaerobic treatments.

Achieved environmental benefits

Reduction in BOD, TOC or COD, phosphorus and nitrogen emission levels.

Environmental performance and operational data

The COD and TN removal efficiency of a WWTP with a SBR in a pig slaughterhouse in Austria are reported to be 99.3 % and 95.8 % respectively, as a yearly average [113, Waxwender et al. 2016].

The COD reduction efficiency is reported to be as high as 95 %, thereby resulting in a lower oxygen depletion potential in receiving waters. Compared to other waste water treatment processes, the energy consumption is reported to be lower, as there is no need for recirculation between tanks, since all the operations are carried out in the same tank. The sludge can be used, e.g. in composting.

COD emission values of 22 mg/l have been reported from a SBR plant for a chicken slaughterhouse without total blood recovery. Values may vary, depending on the COD loading rate of the SBR.

As slaughterhouse waste water contains nitrogen and phosphorus there is an associated risk of the eutrophication of receiving waters. Emission levels as low as 0.2 mg/l of ammonium and < 1 mg/l of nitrates have been measured after SBR waste water treatment in chicken slaughterhouses, although it is reported that in practice the average levels in a plant with optimal operation are around 1-2 mg/l of ammonium and 5-15 mg/l of nitrates.

SBRs can alternate anoxic periods with aerobic periods, thereby removing nitrogen from the waste water. The length of the anoxic periods can be adjusted to create anaerobic conditions which facilitate an increase in phosphorus uptake by biological sludge and thereby an increase in phosphorus removal.

It is reported that odour is not a problem if the biological reactor and the equalisation tank are well aerated.

It is reported that there is a low risk of accidents, since the plant works automatically and requires very little control by personnel.

It is reported that a de-foaming agent is the only chemical required and only during the first week of starting up, due to blood in the waste water.

Table 2.8, Table 2.9 and Table 2.10 show data for a pilot plant and for three existing SBR WWTPs in poultry slaughterhouses.

Table 2.8: Operational data for a SBR at a 40 m³/d poultry slaughterhouse

Reference	Slaughterhouse A					
Waste water	Poultry slaughterhouse					
Flow	40 m ³ /d					
Design	HRT = 3 days					
Pretreatments	0.6 mm screening + degreasing DAF unit + aerated equalisation (HRT = 1.5d)					
Net sludge production	0.06 kg SS/Kg COD					
Parameters	pH	Conductivity (mS/cm)	COD (mg/l)	TKN (mg/l)	NH ₄ ⁺ (mg/l)	NO ₃ ⁻ (mg/l)
Inlet (equalisation tank)	7-8	3.0-4.5	2 800-4 200	300-475	–	5
Outlet	7-8	1.8-2.3	< 200	–	< 5	< 30
Minimum value	–	–	42	–	0.4	14.6
<i>Source:</i> [130, COM 2005]						

Table 2.9: Operational data for a SBR at a 100 m³/d poultry slaughterhouse

Reference	Slaughterhouse B					
Waste water	Poultry slaughterhouse					
Flow	100 m ³ /d					
Design	HRT = 2 days					
Pretreatments	1 mm screening + equalisation tank + DAF primary unit					
Net sludge production	SBR = 0.023 kg SS/kg COD Primary flotation approx. 4000 l/day at 4 % dryness					
Parameters	pH	Conductivity (mS/cm)	COD (mg/l)	TKN (mg/l)	NH ₄ ⁺ (mg/l)	NO ₃ ⁻ (mg/l)
Inlet (equalisation tank)	6.4-8.2	3.3-4.5	2 900-7 250	200	–	2.5
Outlet	6.8-8.5	2.5-3.5	< 100	–	< 25	< 10
Minimum value	–	–	22	–	0.2	0.8
<i>Source:</i> [130, COM 2005]						

Table 2.10: Operational data for a SBR at a 470 m³/d poultry slaughterhouse

Reference	Slaughterhouse C					
Waste water	Poultry slaughterhouse					
Flow	470 m ³ /d					
Design	HRT = 1.25 d x 2 SBR = 2.5 d					
Pretreatments	0.3 mm screening + degreasing DAF unit					
Net sludge production	0.21 kg SS/kg COD					
Parameters	pH	FOG (mg/l)	COD (mg/l)	TKN (mg/l)	NH ₄ ⁺ (mg/l)	NO ₃ ⁻ (mg/l)
Inlet (equalisation tank)	5.8-6.4	400-725	3 300-3 820	227	–	–
Outlet	6.1-7.4	1-35	< 150	–	< 20	< 5
Minimum value	–	0.8	93	–	0.4	< 1
<i>Source:</i> [130, COM 2005]						

The SBR is automated and controlled using a PLC. The main controls are for the cleaning of the screens and the degreasing units rather than for the operation of the technique. The operation of the SBR is monitored by the periodic measurement of V₃₀ values, i.e. by measuring the volume of 1 litre of sludge from the reactor after 30 minutes sedimentation time.

The cycle can be adjusted easily at the touch panel of the PLC and as required by the properties of the inlet waste water, e.g. if the COD:N changes or if there is a problem due to the appearance of filamentous bacteria, which create bulking.

The sludge is normally dewatered in a decanter to reduce its volume.

Cross-media effects

These include energy consumption for aeration combined with mixing in the aeration tank. Aerobic biological treatment produces a relatively large amount of excess activated sludge that, unless used in other applications (e.g. biogas, composting), needs to be disposed of.

Most of the carbonaceous contamination ends up as CO₂ emissions, which eventually contribute to global warming. The nitrates output is higher than the input, because all of the TKN nitrifies into nitrates. This is compensated for by the TKN output being very much lower than the input. When denitrification also takes place in the process, nitrates levels in the output can be reduced.

Technical considerations relevant to applicability

Applicable to all SA installations.

The technique is reported to have the advantage of not requiring much space as there is no requirement for a clarification system (sedimentation or flotation units) or separate anoxic treatment for denitrification or phosphorus removal. It operates at a high solids concentration (MLVSS = 4 000-5 000 mg/l), so low volumes are required.

Economics

Investment costs

The reported prices of some slaughterhouse SBR treatment plants are shown in Table 2.11.

Table 2.11: Reported prices of SBR treatment plants in 6 slaughterhouses

Name	Flow (m ³ /d)	COD effluent (mg/l)	Price not including VAT (EUR)	Observations
Slaughterhouse A	40	200	63 106	Civil works not included.
Slaughterhouse B	200	160	96 162	Civil works not included.
Slaughterhouse C	570	160	280 524	Civil works and sludge line included. Stainless steel tanks and centrifuge decanter sludge line.
Slaughterhouse D	1 500	*1 750	187 305	Civil works and sludge line included. Galvanised tanks and centrifuge decanter sludge line. Existing pretreatment.
Slaughterhouse E	160	160	75 685	Civil works not included.
Slaughterhouse F	200	160	110 115	Civil works partially included.

* COD value required by local permit, before treatment at a municipal WWTP
 Source: [130, COM 2005]

Operational costs

The range of electrical costs reported was reported to be EUR 0.12-0.25/m³ (cost in 2005), with a EUR 0.06/kWh cost for electricity. Generally, there are no chemical reagent costs.

Driving force for implementation

The main driving force for the use of SBR in slaughterhouses is its capacity for removing nitrogen contents with a high efficiency and low investment and running costs. The technique is flexible and conditions such as the length and frequency of anoxic periods, filling velocity, settling time and anaerobic periods can be easily altered using a PLC. The technique does not require a lot of space.

Example plants

At least three poultry slaughterhouses in Spain, one ostrich slaughterhouse in Cyprus and several pig, poultry and cattle slaughterhouses in the Netherlands.

Reference literature

[91, Jimenéz R. 2002], [93, Hydrotech Water and Environmental Engineering Ltd 2001], [102, The Netherlands 2003], [113, Waxwender et al. 2016], [204, TWG 2021], [121, Giner-Santonja et al. 2019].

2.3.6.3.1.3 Trickling filters

Description

Waste water is distributed over a filter medium where biomass grows as a film.

Technical description

In fixed-film aerobic systems such as trickling filters, the biomass grows as a film on the surface of packaging media and the waste water is distributed so as to flow evenly across it. The trickling filter medium normally consists of rocks or various types of plastic. The treated liquid is collected under the media and passed to a settling tank from where part of the liquid can be recycled to dilute the pollutant load of the incoming waste water. Variations include alternating double filtration or permanent double filtration.

The moving bed trickling filter (MBTF) is a sludge-on-carrier aerobic biological filter for the treatment of waste water, waste gases and air and air/water mixtures. It is possible to treat waste water and air simultaneously. The MBTF comprises a vertical cylindrical tank filled with plastic spheres. The spheres, which are made of durable material, act as a carrier material for microorganisms. The waste water is fed into the filter at the top, whilst the air flows through the filter parallel or countercurrently to the water. Intensive mixing takes place in the filter and the contaminants in the water and air are broken down by the microorganisms. A special feature is the fact that a number of the microorganism-carrying spheres are periodically removed from the bottom of the filter and cleaned. The microorganisms removed from the spheres are thickened to a compact sludge in the cone of the filter. The cleaned spheres are returned to the top of the filter. This unique integrated cleaning procedure makes it possible to control the amount of microorganisms and makes clogging of the filter impossible.

The MBTF is shown in Figure 2.38.

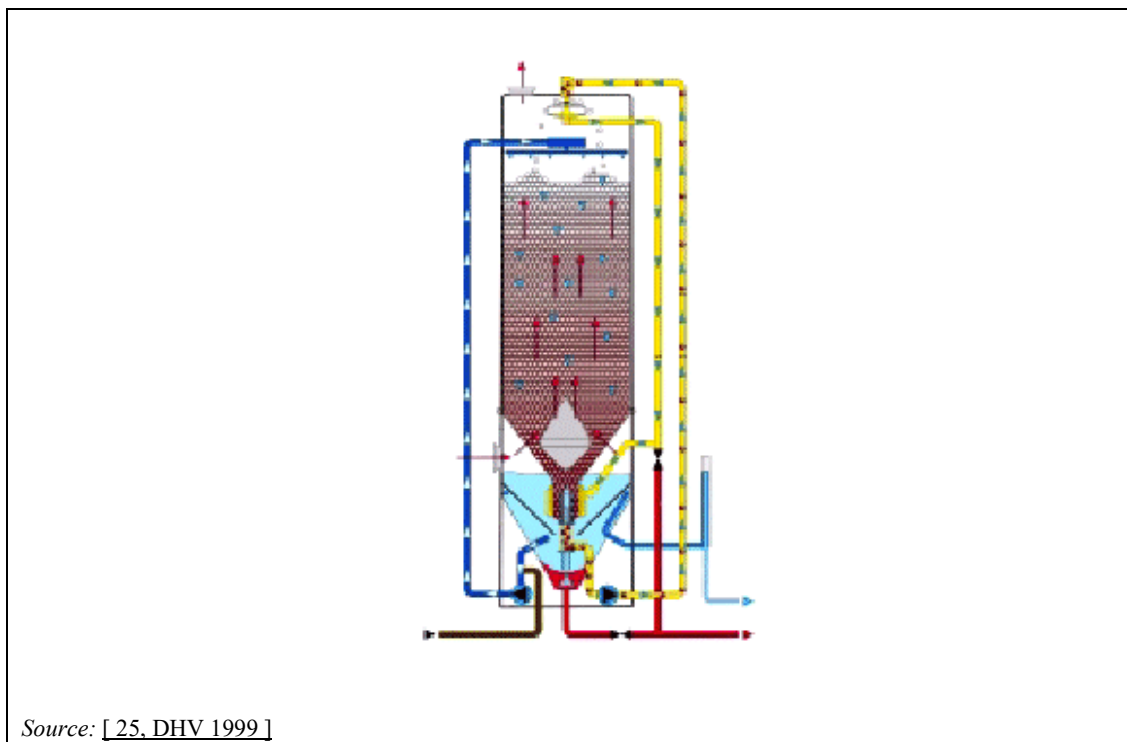

Figure 2.38: Diagram of a moving bed trickling filter designed to treat waste water and emissions to air

Achieved environmental benefits

Low energy consumption. COD levels and nitrogen compounds are reportedly reduced by 90 % and 55 %, respectively.

Environmental performance and operational data

Compared to other systems for the treatment of air/gas or waste water, the MBTF is characterised by a high efficiency and a high capacity. Depending on the concentrations and flows, a reactor with a diameter of 4 metres could treat a waste gas flow of 30 000 Nm³/h of air while simultaneously treating 20 m³/h of waste water. For highly concentrated flows or with very strict effluent requirements other gas:liquid ratios are feasible.

MBTFs have proven to be relatively insensitive to suspended solids and fats in the waste water stream. This often makes the use of coagulants or flocculants in the pretreatment unnecessary.

Cross-media effects

Potential odour nuisance.

Technical considerations relevant to applicability

Generally applicable.

Economics

Filter costs are compensated for by the reduced waste water charges. With combined treatments there is no need to invest in separate air/gas treatment techniques.

Example plants

A poultry slaughterhouse in the Netherlands.

Reference literature

[25, DHV 1999], [59, The Netherlands 2002], [121, Giner-Santonja et al. 2019] [204, TWG 2021].

2.3.6.3.2 Anaerobic treatment

2.3.6.3.2.1 Anaerobic contact process

Description

An anaerobic process where waste water is mixed with recycled sludge solids and then digested in a sealed reactor. The water/sludge mixture is separated externally.

Technical description

See the FDM BREF [[121, Giner-Santonja et al. 2019](#)].

Achieved environmental benefits

See the FDM BREF [[121, Giner-Santonja et al. 2019](#)].

Environmental performance and operational data

In a chicken slaughterhouse which also includes a rendering and a fat melting plant (BE020), the anaerobic contact process is applied. Maximum COD effluent values in the range of 29-34 mg/l are reported for the years 2016-2018.

Average COD effluent values around 60 mg/l are reported in a cattle slaughterhouse (FR231).

Cross-media effects

See the FDM BREF [[121, Giner-Santonja et al. 2019](#)].

Technical considerations relevant to applicability

See the FDM BREF [[121, Giner-Santonja et al. 2019](#)].

Economics

No information provided.

See the FDM BREF [[121, Giner-Santonja et al. 2019](#)].

Driving force for implementation

See the FDM BREF [[121, Giner-Santonja et al. 2019](#)].

Example plants

Various SA installations.

Reference literature

[[121, Giner-Santonja et al. 2019](#)], [[178, TWG 2020](#)].

2.3.6.3.2.2 Internal circulation reactors

Description

Two UASB (upflow anaerobic sludge blanket) reactor compartments can be put on top of each other, one high-loaded and one low-loaded.

Technical description

See the FDM BREF [[121, Giner-Santonja et al. 2019](#)].

Achieved environmental benefits

See the FDM BREF [[121, Giner-Santonja et al. 2019](#)].

Environmental performance and operational data

One of the main advantages of the internal circulation reactor is that it can undergo a certain amount of self-regulation, irrespective of the variations in incoming flows and loads. As the load

increases, the quantity of methane generated also increases, and further increases the degree of recirculation and hence dilution of the incoming load.

In a pig slaughterhouse (ES103), average COD effluent values in the range of 17-90 mg/l are reported for the years 2016-2018.

Cross-media effects

See the FDM BREF [[121, Giner-Santonja et al. 2019](#)].

Technical considerations relevant to applicability

See the FDM BREF [[121, Giner-Santonja et al. 2019](#)].

Economics

No information provided.

See the FDM BREF [[121, Giner-Santonja et al. 2019](#)].

Driving force for implementation

See the FDM BREF [[121, Giner-Santonja et al. 2019](#)].

Example plants

Several SA installations.

Reference literature

[[121, Giner-Santonja et al. 2019](#)], [[178, TWG 2020](#)].

2.3.6.3.3 Aerobic/anaerobic treatment

2.3.6.3.3.1 Membrane bioreactor

Description

A combination of activated sludge treatment and membrane filtration. Two variants are used: a) an external recirculation loop between the activated sludge tank and the membrane module; and b) immersion of the membrane module in the aerated activated sludge tank, where the effluent is filtered through a hollow fibre membrane, with the biomass remaining in the tank.

Technical description

See the FDM BREF [[121, Giner-Santonja et al. 2019](#)].

Economics

See the FDM BREF [121, Giner-Santonja et al. 2019]. An investment of EUR 1 million to install an ultrafiltration membrane process was required in a turkey slaughterhouse [186, Roudier et al. 2013].

Driving force for implementation

See the FDM BREF [121, Giner-Santonja et al. 2019].

Example plants

Various SA installations.

Reference literature

[121, Giner-Santonja et al. 2019], [186, Roudier et al. 2013], [187, GE 2020], [204, TWG 2021].

2.3.6.4 Nitrogen removal

2.3.6.4.1 Nitrification and/or denitrification

Description

A two-step process that is typically incorporated into biological waste water treatment plants. The first step is the aerobic nitrification where microorganisms oxidise ammonium (NH_4^+) to the intermediate nitrite (NO_2^-), which is then further oxidised to nitrate (NO_3^-). In the subsequent anoxic denitrification step, microorganisms chemically reduce nitrate to nitrogen gas.

Technical description

A more detailed technical description of biological nitrification and denitrification can be found in the CWW BREF [154, Brinkmann et al. 2016].

The activity of the nitrifying bacteria can be affected by several factors in SA installations (e.g. oxygen, temperature, pH, phosphate, salt fluctuations). Waste waters with a shortage of phosphate (e.g. in gelatine manufacturing installations) or with high salt concentrations (e.g. in bone processing) may require phosphate dosing and restarting of the process (e.g. when significant salt fluctuations occur).

Achieved environmental benefits

Nitrogen emission levels are reduced and energy is saved.

Environmental performance and operational data

This technique has the potential to achieve a high removal efficiency, a high process stability and reliability, relatively easy process control and space requirements.

Cross-media effects

Biological nitrification and denitrification imply the consumption of energy. In some cases, an external carbon source for nitrate removal needs to be added.

Technical considerations relevant to applicability

Nitrification may not be applicable in the case of high chloride concentrations (e.g. above 10 g/l) and if the reduction of the chloride concentration prior to nitrification would not be justified by the environmental benefits. Moreover, the nitrification process may not be applicable when the temperature of the waste water is low (e.g. below 12 °C). This technique is not applicable when the final treatment does not include a biological treatment.

Economics

Investment costs of EUR 1 300 000 are reported for an aerobic treatment step for nitrification and denitrification in the FDM sector (treating around 1 500 m³/day of waste water) [121, Giner-Santonja et al. 2019].

Driving force for implementation

Member States' legislation to reduce eutrophication of fresh water.

Example plants

This technique is widely used in SA installations.

Reference literature

[121, Giner-Santonja et al. 2019], [154, Brinkmann et al. 2016].

2.3.6.4.2 Partial nitritation-anaerobic ammonium oxidation**Description**

A biological process that converts ammonium and nitrite into nitrogen gas under anaerobic conditions. In waste water treatment, anaerobic ammonium oxidation is preceded by a partial nitrification (i.e. nitritation) that converts about half of the ammonium (NH₄⁺) into nitrite (NO₂⁻).

Technical description

The anaerobic ammonium oxidation process is used for nitrogen removal instead of the classic nitrification-denitrification process. This conversion is a shortcut in the natural nitrogen cycle where ammonium and nitrite are converted to nitrogen gas. In a first aerated step (preventing conditions for nitrate formation), ammonium is oxidised to nitrite; then the conversion of nitrite to nitrogen gas takes place in an anaerobic second step where the relevant bacteria are present.

As one oxidation step (nitrite→nitrate) is avoided by applying the partial nitritation-anaerobic ammonium oxidation process, less oxygen/air is used. Also, lower amounts of sludge are generated, in relation to the classic nitrification-denitrification process.

The water must have low COD (pretreated in an anaerobic treatment step) before this process can take place.

Achieved environmental benefits

Nitrogen emission levels are reduced and energy is saved.

Environmental performance and operational data

Typical nitrogen volume loading rates of 1-2 kg Nm³ per day are applied. The conventional activated sludge treatment of waste water in a potato processing installation was retrofitted with a partial nitritation-anaerobic ammonium oxidation process in 2011. The applied process has a total nitrogen (TN) removal efficiency of around 90 %. Ammonium and nitrate are monitored in the aerated tank to optimise the oxygen supply. The organic load is also monitored and adjusted through recirculation of waste water.

Cross-media effects

Ammonium oxidation implies the consumption of energy to supply oxygen.

Technical considerations relevant to applicability

This technique is not applicable when the final treatment does not include a biological treatment. The technique may not be applicable when the temperature of the waste water is low.

Economics

The operational costs of the WWTP can be reduced to around 60 % compared to a conventional nitrification/denitrification step.

Driving force for implementation

Member States' legislation to reduce eutrophication of fresh water.

Example plants

No information provided.

Reference literature

[121, Giner-Santonja et al. 2019], [204, TWG 2021].

2.3.6.5 Phosphorus removal

2.3.6.5.1 Precipitation

Description

The conversion of dissolved pollutants into insoluble compounds by adding chemical precipitants. The solid precipitates formed are subsequently separated by sedimentation, air flotation, or filtration. Multivalent metal ions (e.g. calcium, aluminium, iron) are used for phosphorus precipitation.

Technical description

Chemical precipitation of phosphorus is a frequently utilised method of phosphorus removal that can be carried out at different stages in a biological WWTP. Phosphorus precipitation is the transformation of the soluble phosphates present in the waste water to insoluble chemical compounds (salts) followed by the removal of these insoluble precipitates by sedimentation or filtration. The most commonly utilised chemicals contain lime, aluminium (mainly alum) and iron (mainly ferric chloride). Phosphorus has to be dosed in order to reach a specific C-N-P ratio for a highly efficient waste water treatment.

Achieved environmental benefits

Reduced phosphorus emission levels.

Environmental performance and operational data

In a pig slaughterhouse (AT004), precipitation is applied after treatment with SBR. Average Total P effluent values in the range of 0.20-0.62 mg/l are reported for the years 2016-2018.

In a gelatine manufacturing installation (SE190), precipitation is applied after treatment with the activated sludge process. Maximum Total P effluent values in the range of 0.21-0.42 mg/l are reported for the years 2016-2018.

Cross-media effects

Generation of sludge and consumption of chemical precipitants. Metal phosphate salts, such as iron or aluminium, might not be used as fertilisers in agriculture because the iron or aluminium phosphates are not available for plants under normal pH conditions.

Economics

No information provided.

See the FDM BREF [121, Giner-Santonja et al. 2019].

Technical considerations relevant to applicability

Generally, there are no technical restrictions to the applicability of this technique.

Driving force for implementation

To reduce the potential for eutrophication of fresh water.

Example plants

This technique is widely used in SA installations.

Reference literature

[121, Giner-Santonja et al. 2019], [178, TWG 2020], [204, TWG 2021].

2.3.6.5.2 Enhanced biological phosphorus removal**Description**

A combination of aerobic and anaerobic treatment to selectively enrich polyphosphate-accumulating microorganisms in the bacterial community within the activated sludge. These microorganisms take up more phosphorus than is required for normal growth.

Technical description

SA waste water may contain significant amounts of phosphorus if the cleaning agents used contain phosphate ingredients. Biological treatment methods can be used for phosphorus removal. These methods are based on stressing the microorganisms in the sludge so that they will take up more phosphorus than is required for normal cell growth. Two types of processes used for enhanced biological phosphorus removal (EBPR) are described:

- The proprietary A/O process for mainstream phosphorus removal is used for combined carbon oxidation and phosphorus removal from waste water. This process is a single-sludge suspended growth system that combines anaerobic and aerobic sections in sequence.
- In the proprietary phostrip process for side-stream phosphorus removal, a portion of the return activated sludge is diverted to an anaerobic phosphorus stripping tank.

Under certain operating conditions, more phosphorus than is needed may be taken up by the microorganisms, which is known as the luxury uptake. Under anaerobic conditions, the microorganisms break the high-energy bonds in internally accumulated polyphosphate, resulting in the release of phosphate and the consumption of organic matter in the form of volatile fatty acids (VFAs) or other easily biodegradable organic compounds. When the microorganisms are then put under aerobic conditions, they take up phosphate, forming internal polyphosphate molecules. This luxury uptake results in more phosphate being included in the cells than was released in the anaerobic zone, so the total phosphate concentration in the solution is reduced. When the microorganisms are wasted, the phosphate contained is also removed. A sufficient supply of VFAs is the key to removing phosphorus biologically.

EBPR can be accomplished in conjunction with treatment plants that nitrify and/or denitrify, with and without primary sedimentation. Where both nitrogen and phosphorus are to be removed, combined processes are used most commonly.

Achieved environmental benefits

Reduced phosphorus, BOD and TOC or COD emission levels.

Environmental performance and operational data

In a slaughterhouse mainly for pigs (SE181), biological phosphorus removal is applied after treatment with the activated sludge process and aerobic lagoons. 95th percentile Total P effluent values in the range of 0.26-0.42 mg/l are reported for the years 2016-2018.

Cross-media effects

Pumping is needed to send the waste water to further aerobic treatment.

Technical considerations relevant to applicability

Generally, there are no technical restrictions to the applicability of this technique.

Economics

No information provided.

See the FDM BREF [121, Giner-Santonja et al. 2019].

Driving force for implementation

To reduce the potential for eutrophication of fresh water.

Example plants

This technique has been reported in several SA installations.

Reference literature

[121, Giner-Santonja et al. 2019], [178, TWG 2020].

2.3.6.5.3 Phosphorus recovery as struvite

See Section 2.3.2.7.

2.3.6.6 Final solids removal

2.3.6.6.1 Coagulation and flocculation

Description

Coagulation and flocculation are used to separate suspended solids from waste water and are often carried out in successive steps. Coagulation is carried out by adding coagulants with charges opposite to those of the suspended solids. Flocculation is carried out by adding polymers, so that collisions of microfloc particles cause them to bond to produce larger flocs.

Technical description

When solid particles cannot be separated by simple gravitational means, e.g. when they are too small, their density is too close to that of water or when they form colloids/emulsions, coagulation and flocculation can be used. This technique converts the substances dissolved in the water into insoluble particles by means of a chemical reaction.

Their effect can be boosted by the addition of precipitation and flocculation agents before the waste water enters the flotation tank. Certain metal salts such as iron (III) sulphate, iron (III) chloride and aluminium sulphate, aluminium chloride and a number of polymers are used for precipitation and flocculation. The quantity and type of flocculation agents and flocculation aids can only be determined conclusively after semi-commercial trials or after the construction of a plant. It is reported that their use is not usually necessary. The application of sludge on agricultural land may be restricted after flocculation, due to metallic salt residues. For this reason, flotation without flocculation and precipitation agents can be selected for new designs, with the subsequent treatment steps dimensioned accordingly.

Coagulation and flocculation may also be used as pretreatment techniques, before biological treatment.

Achieved environmental benefits

Reduction of TSS, FOG and phosphorus emission levels.

Environmental performance and operational data

The effectiveness of coagulation and flocculation and selection of the coagulants depend upon understanding the interaction between the charge, size, shape and density of the particles to be separated. The final selection of the coagulant(s) should be made following thorough jar testing and plant-scale evaluation. Considerations must be given to the required effluent quality, effect

on downstream treatment process performance, cost, method and cost of sludge handling and disposal, and overall net cost at the dose required for effective treatment.

Cross-media effects

Due to the addition of chemicals to the waste water, the dissolved solids/salt content may increase significantly and the solid waste produced might be difficult to reuse or dispose of. Another cross-media effect is the energy consumption for mixing.

Technical considerations relevant to applicability

Generally, there are no technical restrictions to the applicability of this technique.

Economics

This technique produces solid waste which is expensive to dispose of.

Driving force for implementation

No information provided.

Example plants

Various SA installations.

Reference literature

[121, Giner-Santonja et al. 2019].

2.3.6.6.2 Flotation

Description

The separation of solid or liquid particles from waste water by attaching them to fine gas bubbles, usually air. The buoyant particles accumulate at the water surface and are collected with skimmers.

Technical description

Flotation techniques may be used to remove solids and fats before the tertiary treatment, or to separate biological sludge and treated water.

Achieving flotation of the solid particles requires the production of micro-bubbles. There are three methods for producing the bubbles. They are air flotation, i.e. aeration at atmospheric pressure, dissolved air flotation and mechanical flotation.

The basic mechanism of dissolved air flotation (DAF) is the introduction of small air bubbles into the waste water containing the suspended solids to be floated. The fine air bubbles attach themselves to the chemically conditioned particles and, as they rise to the surface, the solids float to the surface with them.

The air is dissolved under pressure, i.e. at 300-600 kPa (3-6 bar). The air is normally introduced into a recycled stream of treated waste water which has already passed through a DAF unit. This supersaturated mixture of air and waste water flows to a large flotation tank where the pressure is released, thereby generating numerous small air bubbles. Here they are accumulated, thickened and removed by mechanical skimming or suction withdrawal. Chemicals such as polymers, aluminium sulphate or ferric chloride can be used to enhance flocculation and, therefore, the adhesion of bubbles.

The floating material is removed by the use of chain conveyor scrapers.

Achieved environmental benefits

Reduction of COD, BOD, nitrogen and phosphorus in waste water and the production of sludge, after dewatering, for use in biogas manufacture. The cleaning efficiency depends on the

equipment, how it is operated and the characteristics of the waste water. The solid materials may be recycled into an animal by-products installation, e.g. for composting, either on the same site, or elsewhere.

Environmental performance and operational data

In air flotation, air bubbles are formed by introducing the gas phase directly into the liquid phase through a revolving impeller or through diffusers. It is reported that aeration alone, at least for a short period, is not particularly effective in bringing about the flotation of solids.

For dissolved air flotation, air is injected while the water is under pressure. The dispersion water used, at 10-20 % of the flow, can be fresh water or waste water recirculated after flotation. The sludge may be scraped off the surface and sent off site for land injection.

Table 2.12 and Table 2.13 give figures for the efficiencies of flotation plants.

Table 2.12: Purification performance of a flotation plant during production and cleaning

		Units	COD	BOD ₅	Fat	Total Kjeldahl Nitrogen	Phosphorus
Production	Influent	mg/l	1 000	498	104	36	10
	Effluent	mg/l	458	142	< 15	23	3.5
	Efficiency degree	%	54	71.5	> 86	36	65
Purification	Influent	mg/l	929	515	106	35	9.8
	Effluent	mg/l	530	237	< 15	32	5
	Efficiency degree	%	43	54	> 86	11	52

Source: [29, Germany 2001]

Table 2.13: Purification performance of a flotation plant using precipitation and flocculation agents

Pollutant	% reduction
BOD	70
Total N	55
Total P	70
Fat	85

Source: [23, Nordic 2001]

Table 2.14 shows further operational data for a rendering plant with a flotation plant using submerged flotation aerators designed for this specific purpose.

Table 2.14: Influent/effluent data – for preliminary mechanical/physico-chemical waste water treatment after rendering

Parameter	Influent	Effluent	% decrease
pH	9.0-9.5	7.7-11	-
Filterable solids (mg/l)	1 530	570	2.7
COD total (mg/l)	5 024	3 416	32.0
Fat (mg/l)	1 590	199	87.5
NH ₄ -N (mg/l)	943	648	31.3
Organic-N (mg/l)	119	39	66.9

Source: [130, COM 2005]

Another report quotes typical COD strengths of slaughterhouse waste waters ranging between 2 900 mg/l and 3 800 mg/l. These can be reduced by a DAF plant, to less than 600 mg/l, prior to trade effluent discharge. Suspended solids can be reduced from about 1 500 mg/l to less than 100 mg/l [4, WS Atkins-EA 2000]. The principal components of a DAF plant are shown in Figure 2.40.

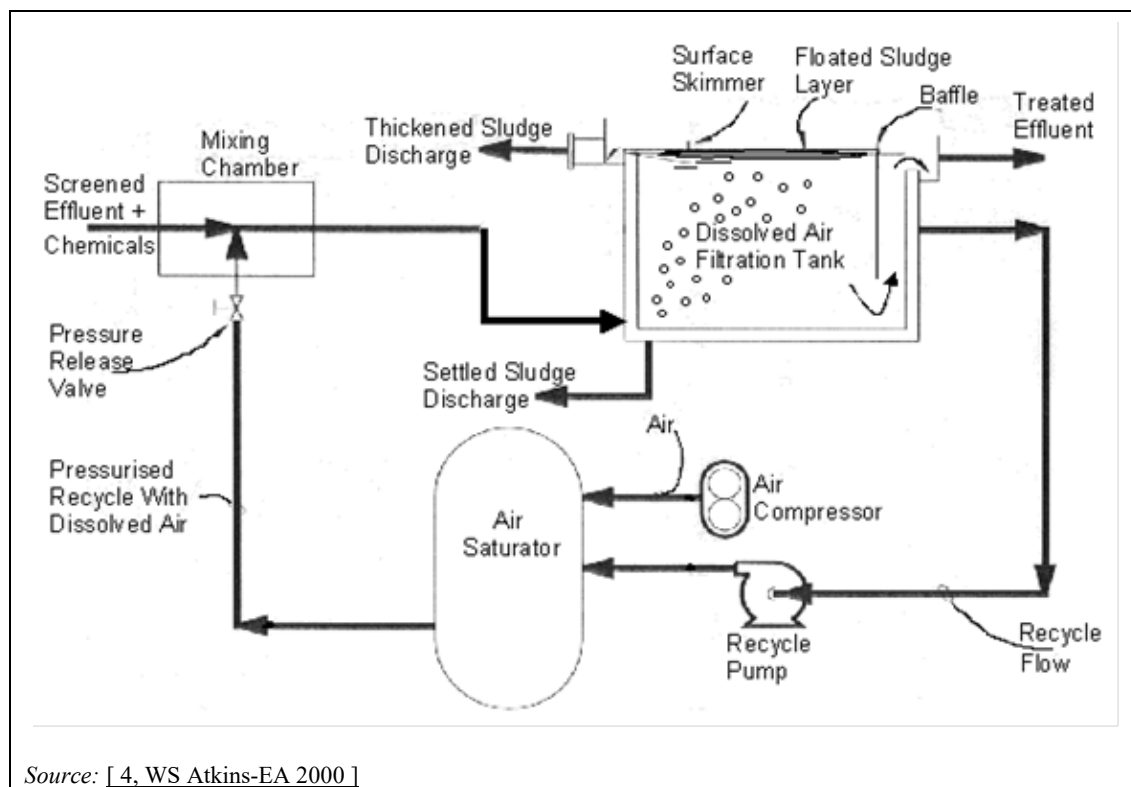

Figure 2.40: Principal components of dissolved air flotation

At a rendering plant using submerged aerators for flotation and a paddle to remove the floating material, with a flow of 15 m³/h and a volume of 12 m³ and surface area of 8 m², a 76 % reduction in fat content and a 42 % reduction in COD are reported. An automatic spraying system controls the formation of foam.

At one German rendering plant, the N-elimination from the waste water amounted to 10 %. At another, it amounted to approximately 30-40 %.

High temperatures and pH values make fat separation difficult. Mechanical separation is reported to be the least sensitive to these parameters.

At an animal carcass disposal plant in Germany, flotation is undertaken using a mixing and equalising vessel designed for a constant effluent inflow of up to 8 m³/h. At this plant, a fat elimination rate of 50 % has been achieved. The COD (homogenised) is only reduced by 16 %, because the excess sludge from the biological treatment plant simultaneously reaches the flotation plant. This can lead to temporary overloading.

Cross-media effects

Flotation plants are a potential source of odour problems. Iron (III) salts also aid odour reduction because they remove H₂S

[26, Finnish Environment Institute and Finnish Food and Drink Industries' Federation 2001].

The presence of metallic salts from flocculation can prevent the sludge from subsequent biological treatment being applied to land.

Technical considerations relevant to applicability

Applicable in all SA installations which produce waste water.

Economics

It has been reported that in many cases the capital expenditure of a DAF plant is justified by reduced trade effluent costs.

Mechanical flotation is reported to incur lower investment and operating costs than other flotation techniques.

It has been reported that the investment cost for a flotation plant with a capacity of 60 m³/h is EUR 125 000-250 000 (2021).

Table 2.15 shows costs and maintenance requirements for a DAF plant treating 750 m³/d.

Table 2.15: Cost and maintenance requirements for DAF treatment (750 m³/d effluent)

	Estimated capital cost	Typical maintenance requirements
Dissolved air flotation (DAF)	GBP 150 000	Up to 2 hours per day cleaning and maintenance may be required.
<i>Source: [13, WS Atkins-EA 2000]</i>		

Driving force for implementation

Reduction of COD, BOD, TSS, nitrogen and phosphorus in waste water.

Example plants

This technique is widely applied in SA installations [178, TWG 2020].

Reference literature

[23, Nordic 2001], [29, Germany 2001], [62, Germany 2002], [105, Belgium 2003], [121, Giner-Santonja et al. 2019], [178, TWG 2020], [204, TWG 2021].

2.3.6.7 Other general techniques applicable in slaughterhouses and animal by-products installations

2.3.6.7.1 Electrocoagulation

Description

Electrocoagulation is the process of applying an electrical charge to water and changing the particle surface charge, allowing suspended matter to form an agglomeration. Treating waste water by electrocoagulation results in a reduction in water pollutants and replaces the chemical coagulation, biological treatment and the nitrogen and phosphorus removal step.

Technical description

Electric current passes through water in combination with highly charged polymeric metal hydroxide species. It uses a proprietary treatment chamber and electricity. An electrocoagulator (EC) reactor is made up of an electrolytic cell with a cathode and an anode, and consists of pairs of conductive metal plates (currently aluminium or iron) in parallel acting as monopolar electrodes (Figure 2.41). The main operation requirements are a direct current power source, a resistance box, and a multimeter [125, Chemicals 2019].

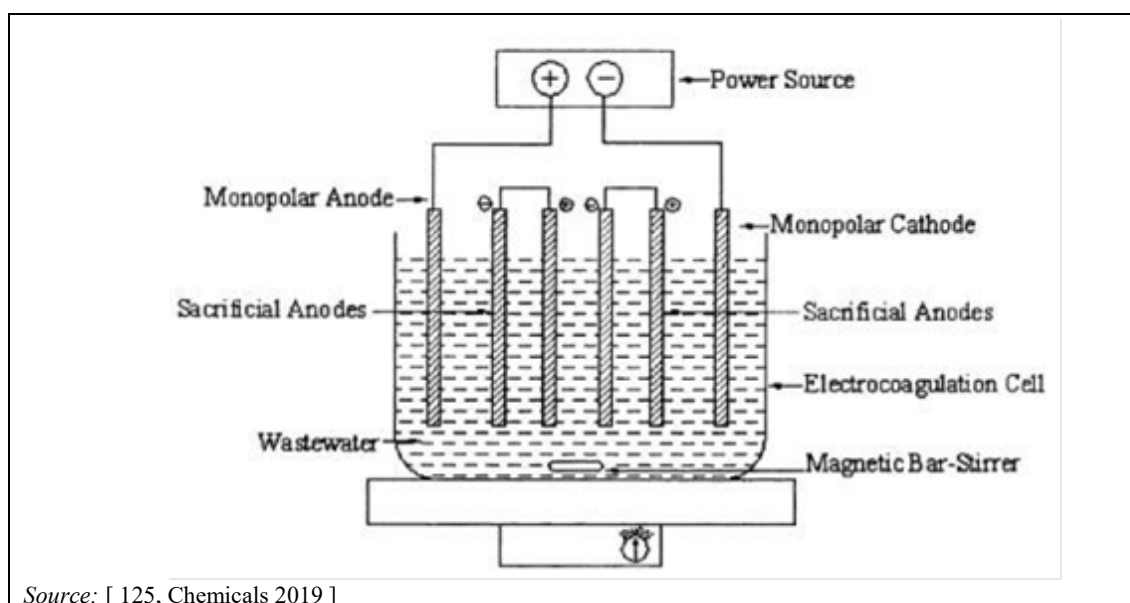
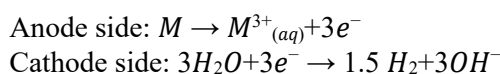

Figure 2.41: Overview of an electrocoagulation plant

Electrocoagulation is similar to chemical coagulation, except that there is *in-situ* generation of coagulant by the dissolution of the ‘sacrificial’ anode (conductive metal plates). When current is generated, hydroxide ions (OH^-) are produced at the anode and hydrogen gas (H_2) at the cathode. Floccs will be formed due to the hydroxide ions and will settle the pollutant, which is then easily removed by sedimentation. Gas bubbles are also formed and will entrain the lighter pollutants to the surface and will be removed by flotation [126, Nwabanne et al. 2017]. The (simplified) reactions occurring at the electrodes are the following:



where M is the metal (i.e. Fe or Al).

Achieved environmental benefits

- Removal of the majority of organic pollutants (BOD, COD, TSS) and heavy metals.
- Lower sludge production.
- Recovery of metals [127, VITO 2019].

Environmental performance and operational data

Table 2.16 shows the removal efficiency of electrocoagulation (with iron and aluminium electrodes) in comparison with a general slaughterhouse waste water treatment (flotation plants (+ flocculants), biological treatment and removal of nitrogen and phosphorus). The majority of the contaminant removal efficiencies with electrocoagulation are similar (except for COD, which is slightly lower).

Table 2.16: Removal efficiencies of electrocoagulation vs general slaughterhouse waste water treatment techniques

Parameter	Average concentration prior to treatment (mg/l) ⁽¹⁾	Electrocoagulation removal efficiency (%) ⁽²⁾		Slaughterhouse waste water treatment removal efficiency (%) ⁽³⁾
		Fe electrode	Al electrode	
COD	4 221	75	79	70 - 97
Oil grease	325	95	95	
Suspended solids	1 164	96	95	

Parameter	Average concentration prior to treatment (mg/l) ⁽¹⁾	Electrocoagulation removal efficiency (%) ⁽²⁾		Slaughterhouse waste water treatment removal efficiency (%) ⁽³⁾
		Fe electrode	Al electrode	
TN	427	70 ⁽⁴⁾	78 ⁽⁴⁾	
TP	50	80 ⁽⁴⁾	90 ⁽⁴⁾	
Electricity consumption	-	10 kWh/m ³	8 kWh/m ³	- ⁽⁵⁾

NB:
⁽¹⁾ [128, Bustillo-Lecompte et al. 2016]
⁽²⁾ At optimal operating conditions of pH = 6, operation time = 30 min, current density = 100 A/m² [129, Ozyonar et al. 2013].
⁽³⁾ [130, COM 2005]
⁽⁴⁾ At optimal operating conditions of pH = 2, operation time = 25 min, current density 110 A/m² [131, Kazem et al. 2012].
⁽⁵⁾ Some electricity consumption is required to operate a conventional WWTP.

Cross-media effects

Higher usage of energy in comparison to traditional slaughterhouse waste water treatment. Electricity use is estimated between 8 kWh/m³ and 10 kWh/m³ for iron and aluminium electrodes, respectively [129, Ozyonar et al. 2013].

Technical considerations relevant to applicability

The electrocoagulation process is simple, but the chemical reaction that can occur can be complex depending on the influent waste water composition. Laboratory tests are therefore required to determine the optimal operating conditions for a specific type of waste water [127, VITO 2019]

Economics

In general, average costs of electrocoagulation are equal to or higher than those of coagulation and flocculation. Typical operational expenses of electrocoagulation are at least EUR 0.15/m³ for large installations (> 1 m³/h). These costs primarily consist of electricity use and, to a lesser degree, the replacement of electrodes [127, VITO 2019].

Little specific cost information is available due to the absence of large-scale plants in the slaughterhouse sector. For an installation with waste water volumes of 10 m³/h, the investment cost would be around EUR 100 000 [132, MLA 2003]. The operational cost, principally driven by the current density, will mainly determine if this technology is cost-effective. At optimal working conditions, the operational cost is about USD 0.9/m³ and USD 2.75/m³ for iron and aluminium electrodes, respectively [129, Ozyonar et al. 2013].

Driving force for implementation

Replacement of three waste water treatment steps (chemical coagulation, biological treatment and the nutrients removal) by one step.

Example plants

Burrangong Meat Processors in NSW Australia [132, MLA 2003].

Reference literature

[127, VITO 2019], [128, Bustillo-Lecompte et al. 2016], [129, Ozyonar et al. 2013], [130, COM 2005], [131, Kazem et al. 2012], [132, MLA 2003].

2.3.7 Techniques to avoid the use of harmful substances

2.3.7.1 Proper selection of cleaning chemicals and/or disinfectants

Description

Avoidance or minimisation of the use of cleaning chemicals and/or disinfectants that are harmful to the aquatic environment, in particular those that contain priority substances considered under Directive 2000/60/EC of the European Parliament and of the Council (Water Framework Directive). When selecting the cleaning chemicals and/or disinfectants, hygiene and food safety requirements are taken into account. This technique is part of the CMS (see Section 2.3.1.3).

Technical description

Chemicals such as chlorine, quaternary ammonium compounds, bromine- or iodine-based products are routinely used to maintain the hygiene of SA sites. However, these are often potentially hazardous in combination with organic residues. For example, cleaning agents containing active chlorine can produce hazardous organic halogens and chlorinated hydrocarbons, which may impair or disturb waste water treatment. Moreover, to work safely and effectively, such chemicals typically require large volumes of water and often high temperatures. Then, when cleaning is complete, further treatment, with a significant associated environmental impact, is often needed to clean up any effluent.

Certain detergents, such as nonyl phenol ethoxylate (NPE) and alkylbenzene sulphonates (LAS), pose a high risk to the environment and can be avoided in all cleaning operations. NPE has been used as a cleaning agent in slaughterhouses and animal by-products installations. Nonylphenol is a metabolite of the nonylphenol ethoxylate group. It is toxic to terrestrial and aquatic organisms, in which it exhibits hormone-like effects.

Avoiding or minimising the production of harmful residues can include the following measures:

- use of less harmful cleaning chemicals;
- use of biochemical cleaning agents containing naturally occurring enzymes for cleaning and disinfection processes;
- reduction of the use of cleaning chemicals (e.g. EDTA, halogenated biocides, acids).

Sodium hypochlorite is frequently used in SA installations for cleaning and disinfection. Hypochlorites are classified as Aquatic Acute 1 and very toxic to aquatic life.

Several studies have demonstrated the potential formation of hazardous halogenated by-products (e.g. chloroform, chlorinated acetic acids and trichloroacetyl groups [171, Jensen et al. 2016]) derived from the uses of hypochlorites in the presence of organic matter.

Peracetic acid is the most suitable candidate to replace hypochlorites due to the lower production of organohalogen compounds and its high degradability. Peracetic acid breaks down into harmless acetic acid, oxygen and water. Products based on peracetic acid have the advantage of also being less corrosive than hypochlorite to metals, so they are very suitable for the disinfection of metallic surfaces. The main hazard of the substance as far as humans are concerned is direct exposure, since it is corrosive. Information retrieved from the ECHA database indicates that peracetic acid is not genotoxic in rats and mice [170, Escudero 2015].

Although quaternary ammonium compounds are also effective substances for disinfection in domestic and professional environments, little reliable evidence on their toxicity is available. Their use should be minimised as they could be harmful to the environment and health [170, Escudero 2015]. Additionally, quaternary ammonium can be a toxic substance for nitrifying bacteria in a biological WWTP [204, TWG 2021].

Ozone (O₃) in water solution can destroy the cell membrane of pathogens by oxidising the phospholipids and lipoproteins and has the advantage of itself quickly breaking down into harmless oxygen. Ozone is effective against a wide range of microbes including bacteria, yeasts, moulds, viruses and spores. The incorporation of ozone-rich water in CIP and other cleaning processes has the advantage over traditional disinfectants that no residues are left and the ozone is applied cold. This reduces the volume of water necessary to rinse detergents from the plant and the energy use associated with heating the water.

Using products with an EU Ecolabel is a voluntary commitment to a sustainable environment. From raw materials to production, packaging, distribution and disposal, EU Ecolabel products have been evaluated by independent experts to ensure that they meet the criteria that reduce their environmental impact. Detergents that meet the criteria of the European Ecolabel are readily biodegradable and are not toxic to the environment.

Achieved environmental benefits

- Reduction in consumption of cleaning agents and detergents.
- Reduced risk of AOX pollution [171, Jensen et al. 2016].

Cross-media effects

No information provided.

Technical considerations relevant to applicability

There are no technical restrictions to the applicability of this technique.

Economics

No information provided.

Driving force for implementation

Use of less harmful substances.

Example plants

This technique is implemented in multiple SA installations.

Reference literature

[23, Nordic 2001], [121, Giner-Santonja et al. 2019], [170, Escudero 2015], [171, Jensen et al. 2016].

2.3.7.2 Management of water and detergent consumption

Description

Recording of the consumption of water and detergents on a daily basis to detect deviations from normal operation for its optimisation. This technique is part of the environmental management system of the installation (see Section 2.3.1.1).

Technical description

If the consumption of water and detergents and cleanliness can be recorded on a daily basis it is possible to detect deviations from normal operation and then to monitor and plan ongoing efforts to reduce the future consumption of both water and detergents without jeopardising hygiene.

Trials can also be undertaken, e.g. using less or no detergents; using water at different temperatures; using mechanical treatment, i.e. the use of 'force' in the water pressure; and using scouring sponges, brushes, etc.

Monitoring and controlling the required cleaning temperatures can enable the required cleaning standard to be achieved without excessive use of cleaning agents.

Achieved environmental benefits

Reduced consumption of water and detergent and of the energy required to heat the water. The reduction potential depends on the cleaning requirements at each part of the installation or equipment to be cleaned.

Environmental performance and operational data

There are a small number of legal food and veterinary requirements which specify water consumption requirements. It is also recognised by veterinarians, operators and customers that water overuse can lead to cross-contamination. Inadequate hygiene controls cause hygiene problems, which can result in product rejection or a shortened shelf life. Improvements in waterless cleaning techniques can be achieved, e.g. by using flow restrictions on the water supply and by regulating the water pressure from high-pressure wash to medium- and low-pressure for night and day cleaning, respectively. The frequency of wet cleaning can also be assessed with the objective of reducing the number of full wet cleans to one per day instead of one at every break, or as is the case in some slaughterhouses virtually constant wet cleaning, by someone who hoses down the slaughter hall approximately every 15 minutes.

Cross-media effects

None.

Technical considerations relevant to applicability

Applicable in all SA installations.

Economics

The technique results in reduced water and detergent costs.

Driving force for implementation

Reduced water and detergent costs.

Reference literature

[26, Finnish Environment Institute and Finnish Food and Drink Industries' Federation 2001], [23, Nordic 2001], [60, United Kingdom 2002].

2.3.7.3 Reuse of cleaning chemicals in cleaning-in-place

Collection and reuse of cleaning chemicals in cleaning-in-place (CIP). When reusing cleaning chemicals, hygiene and food safety requirements are taken into account.

See also Section 2.3.5.2.3.

2.3.7.4 Dry cleaning

See Section 2.3.5.2.1.

2.3.7.5 Optimised design and construction of equipment and process areas

See Section 2.3.5.2.5.

2.3.8 Techniques to reduce emissions to air

2.3.8.1 Techniques applicable to a number of pollutants

2.3.8.1.1 Fuel choice

For more information, consult the LCP BREF [[180, Lecomte et al. 2017](#)].

Description

The use of fuel (including support/auxiliary fuel) with a low content of potential pollution-generating compounds (e.g. low sulphur, ash, nitrogen, fluorine or chlorine content in the fuel).

Technical description

The choice of fossil fuels with a lower content of potential pollution-generating compounds can lead to a significant reduction in emissions to air. In cases where supply is available, choosing or changing to a gaseous fuel may be a viable option. This will normally involve the use of fuels with a low ash content or low sulphur content.

Achieved environmental benefits

Better environmental profile, less emissions.

Technical considerations relevant to applicability

Generally applicable.

Reference literature

[[180, Lecomte et al. 2017](#)].

2.3.8.1.2 Optimisation of thermal oxidation or combustion in boilers

Description

Optimisation of design and operation of boilers or thermal oxidisers to promote the oxidation of organic compounds, as well as to reduce the generation of pollutants such as NO_x and CO.

Technical description

Optimisation of thermal oxidation or combustion in boilers can reduce the emissions of NO_x and CO. This may include:

- optimising the design of the oxidiser:
 - residence time;
 - mixing of the flows (e.g. natural diffusion between turbulent streams, changes in flow direction);
 - combustion chamber;
- monitoring the combustion parameters:
 - oxygen content;
 - carbon monoxide concentration;
 - temperature;
- inspecting the burners regularly, and cleaning them when necessary.

When the oxidised VOCs contain sulphur and/or halogens, further emissions of sulphur dioxide and/or hydrogen halides might be expected. This might require an additional waste gas treatment after thermal oxidation (e.g. absorption), inspecting the burners regularly, and cleaning them when necessary.

Achieved environmental benefits

Reduction of NO_x and CO emissions to air.

Technical considerations relevant to applicability

Generally applicable.

Reference literature

[198, Daginnus et al. 2023].

2.3.8.1.3 Removal of high levels of dust, NO_x and SO_x precursors**Description**

Removal (if possible, for reuse) of high levels of dust, NO_x and SO_x precursors prior to combustion of malodorous gases, thermal oxidation, e.g. by absorption, adsorption or condensation. Additional post-combustion removal of dust, NO_x and SO_x may be carried out using wet scrubbing for example.

Achieved environmental benefits

Reduction of dust, NO_x and SO_x emissions to air.

Technical considerations relevant to applicability

Generally applicable.

Reference literature

[112, Falcke et al. 2017].

2.3.8.2 Techniques mainly used to reduce organic and odour emissions**2.3.8.2.1 Odour management plan****Description**

An odour management plan (OMP) is part of the environmental management system (EMS) of the installation (see Section 2.3.1.1) and includes elements to prevent or reduce odour emissions.

Technical description

The OMP includes the following:

- A protocol containing appropriate actions and timelines.
- A protocol for conducting odour monitoring. It may be complemented by measurement/estimation of odour exposure (e.g. according to EN 16841-1 or -2) or estimation of odour impact.
- A protocol for response to identified odour incidents (including the management of complaints: identification of operations carried out, weather conditions such as temperature, wind direction, rainfall, communication with the authority and with complainant, etc.)
- An odour prevention and reduction programme designed to identify the source(s), to measure/estimate odour exposure, to characterise the contributions of the sources, and to implement prevention and/or reduction measures.

Since animals and materials of animal origin are handled in all SA installations, there are numerous potential sources for the formation of odours. Odour emissions can be caused by diffuse and fugitive sources (e.g. handling of animal by-products) or can derive from channelled release points of the installation (e.g. stack, biofilter). Due to the high number of possible diffuse emission sources, it is necessary to establish comprehensive measures in SA installations that help to prevent and minimise odour emissions. Effective measures target the organisation of the

workflow, the design of an installation and best practices. This includes [204, TWG 2021]:

- well-dimensioned production areas;
- well-dimensioned reception areas for animals or raw materials;
- shutting doors and keeping rooms closed;
- short waiting times for animals, short waiting times for vehicles, short storage times, short transport routes;
- easy-to-clean surfaces and vehicles, frequent cleaning;
- good ventilation of rooms.

The potential impact of malodorous emissions arising from the plant should be gauged from the nature, size and frequency of operation and the distance of neighbours from the plant. Identified sources of malodorous emissions can be further characterised by quantitative measurements of odour concentration, flow rate, temperature, humidity, chemical analysis and the pH.

Achieved environmental benefits

Prevention or reduction of the emissions of those odorous releases that may be offensive and detectable beyond the boundaries of the site.

Environmental performance and operational data

No information provided.

Cross-media effects

No information provided.

Technical considerations related to applicability

The applicability is restricted to cases where an odour nuisance at sensitive receptors is expected and/or has been substantiated.

Economics

No information provided.

Driving force for implementation

Reduction of number of complaints from the neighbourhood.

Example plants

Various SA plants in the data collection.

Reference literature

[121, Giner-Santonja et al. 2019], [164, Giner Santonja et al. 2017].

2.3.8.2.2 Minimisation of biological degradation of animal by-products and/or edible co-products

See Section 2.3.2.6.

2.3.8.2.3 Regular cleaning of installations and equipment

Description

Regular cleaning (e.g. daily) of installations and equipment including areas where animal by-products are stored and processed.

Technical description

Regular, e.g. daily, thorough cleaning of installations and equipment where animal by-products are handled will reduce the risk of diseases being spread by insects, rodents and birds and will help control the formation of malodorous substances.

Achieved environmental benefits

Reduced odour emissions. Insect, rodent and bird control.

Operational data

Cleaning techniques used at SA installations follow the general cleaning methods described in Section 2.1.3.

If raw material containers are emptied and washed frequently, e.g. daily, then decomposing and malodorous materials will not accumulate over long periods of time. Delays in the despatch of animal by-products from the slaughterhouse, together with the long distances travelled, without temperature control provide sufficient time for material to deteriorate and if storage, particularly badly controlled storage, continues on a site, even briefly, odour problems will be exacerbated. Even facilities with a quick turnover of clean material can generate odour problems if good hygiene practices are not observed.

Cross-media effects

Detergents, including disinfectants, are used. Water is consumed during the cleaning process, although the extent depends on the amount of dry cleaning carried out before water is used. There may be opportunities to reuse water from sources which have not been in contact with animals or animal by-products and from the WWTP, depending on the extent of treatment of the waste water and the final use of the by-product.

Applicability

Applicable at all installations storing, handling and treating animal by-products.

Example plants

Various SA plants in the data collection.

Economics

Cheaper and more convenient than dealing with odour and infestation.

Driving force for implementation

Prevention of odour emissions.

Reference literature

[3, Environment Agency 1997], [14, EA 1998], [64, Sorlini G. 2002], [119, EC 2009].

2.3.8.2.4 Cleaning and disinfection of vehicles and equipment used to transport and deliver animal by-products and/or edible co-products

Description

Transport vehicles and delivery equipment (e.g. containers) are cleaned and disinfected after being emptied.

Technical description

After being emptied, delivery vehicles and transport skips are wet-cleaned and disinfected with calculated optimal amounts of sodium hydroxide or sodium hypochlorite.

Wash-water from transport vehicles and delivery equipment is normally sent to the site waste water treatment plant. Given the low volume of water, in comparison to the process-related waste water flow, the presence of sodium hydroxide or sodium hypochlorite generally has no impact on

the waste water treatment plant performance and these chemicals are used at low concentrations [204, TWG 2021].

Achieved environmental benefits

Reduced odour and pest infestation.

Cross-media effects

Subsequent treatment of wash-water required. Sodium hypochlorite contains active chlorine. Disinfection with sodium hypochlorite, followed by incineration of the waste water, provides a source of chlorine for emissions to air.

Driving force for implementation

Prevention of odour emissions.

Example plants

Various SA plants in the data collection.

Reference literature

[30, Nottrodt 2001].

2.3.8.2.5 Dilution of odours by capture into one or more chimneys

Description

The malodorous air is collected from various sources and emitted through one or more chimney stacks.

Technical description

The malodorous air is collected from various sources into one or more high chimney stacks for emission, at a suitable height to ensure sufficient dilution and dispersion of the odour, taking into account the local prevailing climate conditions.

Achieved environmental benefits

Reduced perception of odour problems in the vicinity of the SA installation. No additional by-products are produced.

Environmental performance and operational data

The determination of stack heights for odour control is uncertain and is less precise than for other polluting discharges, because the critical feature of the emission is its olfactory rather than its chemical characteristics. Dispersion modelling can be used for the dimensioning of chimneys. Sensitivity to odours is variable and subjective. Some form of pretreatment prior to release may be required, rather than relying solely on dilution and dispersion of a discharged emission [108, Clitravi - DMRI 2003].

In 2020, a wet rendering plant in Denmark emitted an average of 173 000 Danish ou/s from a 90-metre chimney. A total of 200 000 m³ of air was processed per hour. The high-intensity odour (16 000 m³/h) was treated in a regenerative thermal oxidiser and the low-intensity odour (184 000 m³/h) was treated in a biofilter. After treatment, the volumes were mixed and emitted from the chimney. The plant reported an average odour emission of 3 100 ou/m³ at the emission point [204, TWG 2021].

Cross-media effects

Reduced visual amenity due to the presence of the chimney(s). The production of the malodorous substance has not been prevented.

Energy consumption is increased. For Danish pig slaughterhouses, which have had to invest in central ventilation facilities with high chimneys, this has led to increased electricity consumption,

amounting to between 0.11 kWh and 0.26 kWh per pig, with an average of 0.19 kWh per pig (calculated from data gathered from four pig slaughterhouses) [118, Denmark 2015].

Technical considerations relevant to applicability

Pretreatment is normally required for the types of odours produced at rendering plants.

Economics

Low-cost technique.

Driving force for implementation

Reduction of odour nuisance.

Example plants

A wet rendering plant and pig slaughterhouses in Denmark [118, Denmark 2015], [178, TWG 2020], [204, TWG 2021].

Reference literature

[118, Denmark 2015], [60, United Kingdom 2002], [108, Clitravi - DMRI 2003], [178, TWG 2020], [204, TWG 2021].

2.3.8.2.6 Enclosure of animal by-products and/or edible co-products during transport, reception, loading/unloading and storage

Description

Loading/unloading and reception areas are situated in enclosed ventilated buildings. Appropriate equipment is used for transport and storage of the animal by-products and/or edible co-products.

Technical description

The transport of animals and animal by-products and/or edible co-products outside SA installations is outside the scope of the SA BREF. However, whilst they remain in vehicles, whether within or outside the installation, problems associated with either spillage or leakage of any solid or liquid material or with odour can be reduced by suitable vehicle design, construction and operation. Commission Regulation (EU) No 142/2011 sets requirements for collection and transport of ABP. The reception, offloading and storage of animals and animal by-products can also be undertaken within enclosed areas, in the case of animal by-products, operated under negative pressure, with extractive ventilation connected to a suitable odour abatement plant. If material is tipped from the delivery vehicle, the receiving hoppers can be covered and sealed after filling.

For loading/unloading, one technique that has been applied is the construction of a tunnel/covered area large enough to accommodate the biggest despatch/delivery vehicle likely to visit the site. Odours can be contained if the tunnel has doors at either end, which make a good seal with the walls and which can be opened and shut rapidly with a minimum of effort and inconvenience. If the doors are difficult to operate there is a high probability that they will fall into disuse. High-speed plastic roller-shutter doors, which are less susceptible to damage than metal doors, are commercially available. Ensuring the integrity of the tunnel and the unloading, storage, processing and packing areas can minimise the leakage of odours. Such tunnels can be used without significantly compromising the negative pressure maintained throughout the rest of the installation. For the unloading of animals, the enclosure can also reduce the risk of noise emissions to the surrounding neighbourhood. This is important as noise can be a major problem, especially when pigs are being unloaded.

Doors to areas where animals/animal by-products are loaded/unloaded, stored or treated, can be close-fitting and kept closed other than to allow pedestrian access or the movement of materials.

Self-closing personnel doors can be provided and fitted with alarms, which operate if the doors fail to close within a reasonable period of time based on access requirements.

Negative air pressure in rooms and the enclosure of WWTP balance tanks can also be implemented as further measures to reduce odour emissions.

Achieved environmental benefits

Reduced odour production and emission is achieved during the loading/unloading, storage and subsequent treatment of animal by-products. The use of sealed and leakproof containers also minimises water and soil contamination from spillages and leaks and reduces the risk of infestation by insects, rodents and birds. Enclosure can also provide some temperature control, e.g. due to protection from direct sunlight, which can slow down the decomposition of the animal by-products. Noise emissions can also be reduced, e.g. during the unloading of pigs at slaughterhouses.

Environmental performance and operational data

Current practices in rendering plants are described in Section 4.3.2.2.

In one case-study slaughterhouse using a tunnel with roller-shutter doors, problems arose which prevented their use, mainly due to the ever increasing length of the lorries collecting by-products from the site, which have resulted in the loading tunnel now being too short.

By-products can be collected and stored in covered vessels. Difficulties caused by constant or intermittent feed can be solved by conveying the material into hoppers or chutes for example, instead of dropping it directly into open skips. If the skips are placed outdoors, to ease their delivery and collection, the prevention of odour and vermin problems may be achieved by maintaining conveyors and seals for example, to minimise both the need to open up the equipment and the amount of downtime when it is not available for use.

Cross-media effects

Energy is consumed in providing the ventilation to maintain a negative pressure and when extracting malodorous air to abatement equipment.

Technical considerations relevant to applicability

This technique may not be applicable to existing plants due to lack of space.

A drive-through tunnel has advantages from a health and safety point of view, e.g. it eliminates reversing and it is normally applicable at loading and unloading points in slaughterhouses and animal by-products installations. Where tipping from lorries is required, there may be more restrictions, especially in many existing installations, where the availability of space may be limited. Side tipping into hoppers constructed to the equivalent length of the lorry trailer units, or individual tipping units is required.

Economics

No information provided.

Driving force for implementation

Driving forces include Regulation (EC) No 1069/2009 (the Animal by-products Regulation), odour control, noise reduction, hygiene and the risk of infection from animal by-products which are confirmed to be, or suspected of being, infected with transmissible diseases, such as TSE. The significance of these driving forces varies depending on the type of animal by-product and its intended use. For example, the prevention of the spread of BSE risk material by insects, rodents and birds to material intended for human consumption will make enclosure important.

Example plants

At least one pig slaughterhouse in Denmark has an enclosed area for the loading of animal by-products.

Several rendering plants in Germany have been reported to enclose materials during transport and storage and to ensure that doors are kept closed.

Reference literature

[8, VDI 2008], [203, VDI 1996], [23, Nordic 2001], [32, Sweeney L. 2001], [60, United Kingdom 2002], [62, Germany 2002], [119, EC 2009].

2.3.8.2.7 Refrigeration/cooling of blood

Description

Blood is cooled to a temperature below 10 °C.

Technical description

Blood which cannot be processed within a very short time can be cooled to a temperature below 10 °C at the slaughterhouse immediately after collection (and also at the installation where the blood will be received). This can reduce odour problems and waste water pollution at the blood processing plant.

A pilot-scale investigation gave the values shown in Table 2.17. These relate to emissions from rendering, after 30 hours of storage of blood at 4 °C and 30 °C, respectively.

Table 2.17: Reduced emissions associated with cooling of blood prior to rendering

	4 °C	30 °C
Odour units per m³	1 000	60 000
ppm NH₃	200	675
ppm H₂S	200	300
<i>Source: [23, Nordic 2001]</i>		

Achieved environmental benefits

Prevention of offensive odours from the liquid blood, caused by the degradation of the blood at both the slaughterhouse and the installation where the blood is used or disposed of. If the blood is rendered fresh, there will also be a lower level of emission of offensive odours and waste water contamination arising from the process.

Environmental performance and operational data

One company collects about 50 % of the total Spanish blood, for both processing and rendering. All of that blood is refrigerated at the slaughterhouses. Blood for plasma production is chilled at 4 °C and blood for rendering at 7 °C. The blood is refrigerated at the insistence of the blood processing/rendering company, to avoid its deterioration and subsequent bad odours at the slaughterhouses, during transport and at the processing/rendering plant. This requirement is contained in the contract between the blood processing/rendering company and the slaughterhouse, which also sets out for example blood quality conditions, solid content, temperature and collection prices.

Of the remaining 50 % of Spanish blood, a further 10 % approximately is also refrigerated. Most of the 40 % which is not refrigerated is rendered on the slaughterhouse sites. Most of this blood is rendered at the slaughterhouse itself and, if not, it is usually coagulated in a tank, using steam. The clotted blood is rendered locally and the water goes to the WWTP of the slaughterhouse. There is a risk of odour production during these processes.

Reportedly, refrigeration is the only storage method which enables blood to be transported over long distances and for up to 5 days after being collected.

The blood is stored in closed containers fitted with an air valve, to allow the exhausting of any gas that may be produced. For this reason, the European renders have asked all slaughterhouses to refrigerate their stored blood. It has been reported that if a closed, but not sealed, blood container is not refrigerated the blood will ferment within a few hours of collection and will become malodorous. It is thus recommended that blood should always be refrigerated, whether it is destined for blood processing or rendering. It has been said that maintenance of a low temperature is the single most significant factor in the prevention of odour problems.

The energy for chilling has been reported to be about 1.44 kWh/t of pig carcass. It has been reported that 30.5 kWh of electrical energy is required to cool one tonne of blood to around 5 °C.

It has been reported that the waste water pollution from the rendering of uncooled blood can be as high as 90 kg COD and 9 kg N per tonne of blood, compared to 20 kg COD and 2 kg N per tonne for cooled blood.

Cross-media effects

Energy consumption by the refrigeration plant.

Technical considerations relevant to applicability

The technique is applicable in all SA installations where blood is handled, treated or stored, except where the blood is being treated virtually immediately after bleeding.

If blood is used for food-grade applications, the blood should be cooled accordingly. For lower-value products, it is not standard practice to chill blood at source and road tankers and bulk storage tanks at the processing site are not refrigerated.

Economics

A refrigerated blood tank and associated equipment, with a capacity for a slaughter-line killing 600 pigs per hour, costs about EUR 65 000-70 000.

A refrigeration cost of EUR 0.0025 per litre of blood (1997), i.e. EUR 0.11 for the blood produced by one tonne of pig carcass, has been quoted.

Driving force for implementation

Odour control at the SA installation.

Refrigeration for blood processing is primarily carried out for quality reasons; indeed, one of the raw material quality checks is the smell of fresh blood.

Demand from enforcement authorities to reduce odour during the handling and transportation of blood. Maximum allowable temperatures for blood are specified in EU Regulation 853/2004 on hygiene for food of animal origin [174, EC 2004].

Example plants

Blood is refrigerated to < 10 °C in Danish slaughterhouses, except when treatment is carried out very quickly after slaughter. It is also refrigerated in all Belgian, all German and approximately 55 % of Spanish slaughterhouses, whether it is destined for use or disposal. In France, it is always refrigerated in all slaughterhouses if it is destined for use but when it is destined for disposal only if it cannot be treated quickly after slaughter. In Ireland and the United Kingdom, it is refrigerated only if it is destined to be used and not to be disposed of as waste.

Reference literature

[23, Nordic 2001], [74, Casanellas J. 2002], [75, Woodgate S. 2002], [94, Hupkes H. 2002], [174, EC 2004].

2.3.8.2.8 Biofilter

Description

The waste gas stream is passed through a bed of organic material (such as peat, heather, compost, root, tree bark, compost, softwood and different kinds of combinations) or some inert material (such as clay, activated carbon, and polyurethane), where organic (and some inorganic) components are transformed by naturally occurring microorganisms into carbon dioxide, water, other metabolites and biomass.

A biofilter is designed considering the type(s) of waste input. An appropriate bed material, e.g. in terms of water retention capacity, bulk density, porosity and structural integrity, is selected. Also important are an appropriate height and surface area of the filter bed. The biofilter is connected to a suitable ventilation and air circulation system in order to ensure a uniform air distribution through the bed and a sufficient residence time of the waste gas inside the bed. Biofilters can be divided into open-top biofilters and enclosed biofilters.

Technical description

Successfully operated biofilter systems are commonly characterised by an open design, organic filter media and exhaust air conditioning in an upstream spray humidifier with a closed water circuit (with and without addition of chemicals). Generally, the plant consists of a preliminary unit where the exhaust air is pretreated.

Biofilters comprise an air distribution system and a carrier medium, often made from an organic material, which can support growing microorganisms which feed on malodorous substances and thereby remove odours from the air. The malodorous substances must be caught on the microorganism carrier, which, therefore, must have a sufficiently high surface area. As the microorganisms also require water, the air needs to be kept moist.

Irrespective of the medium, it is important that the gases to be treated pass through the bed at the optimum flow rate. Conventional biofilters are configured as open surface filters (see Figure 2.42) with filter areas ranging between 75 m² and 3 000 m², depending on the waste gas flow to be treated. The residence time required to effectively abate an odour depends on the odour strength and which pollutants are present in the gas. For low-intensity odours, a residence time of at least 30 seconds should be aimed for, rising to up to 60 seconds for very strong odours. To maintain bio-efficiency, and to maximise the biofilter performance it is necessary to control the humidity, pH, oxygen supply and nutrients. The temperature can also affect the overall performance and operation of the biofilter. Filter media temperatures below 5 °C have been measured in the cold season which goes hand in hand with a major deterioration in the odour abatement efficiency.

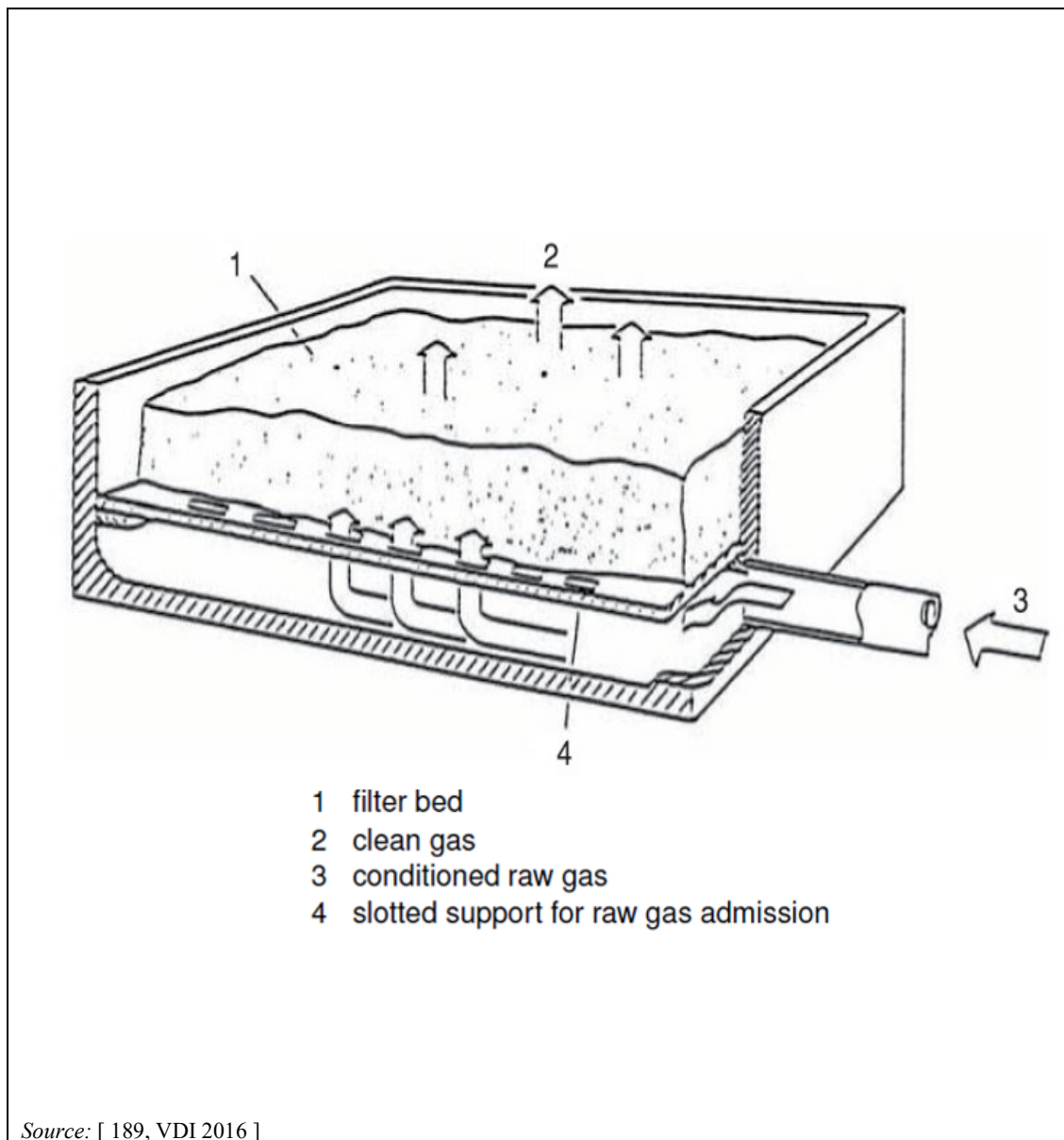

Figure 2.42: Scheme of an open surface biofilter

Sufficient water supply is essential to the function of the biodegradation processes. Moreover, the presence of water as a mass transfer agent is a basic prerequisite for all biodegradation processes. Depending on the type of filter media, a moisture content of between 40 % and 60 % is recommended. The moisture content can be maintained by an irrigation system. A high moisture content in the exhaust is beneficial for biofiltration because it reduces the amount of water required to irrigate the bed. The extracted air is drawn through a humidifier and drop-out pot to remove entrained particulate matter. Humidifiers are typically designed for a water-to-air ratio of 1 l/m³ to 10 l/m³ and a waste gas residence time of > 1 s at an air flow velocity of < 3 m/s [189, VDI 2016]. The air is then ducted to the void beneath the biofilter, which is used to distribute the extracted air uniformly beneath the filter medium, before it passes upwards through it.

The biofilter typically consists of a treatment medium supported on concrete slats above a concrete base. The filter medium must not be allowed to compact, as this will cause a pressure drop across the bed and a loss of efficiency. Typical media include a pasteurised worm compost inoculated with a selected *Pseudomonas* culture, broken pallets, bark, light expanded clay aggregate (LECA), peat and heather supported on seashells and fixed earth of a defined particle

size. Insufficient information has been provided to determine the relative performances of the various media for given odour sources and concentrations.

If air pollutants are present in high concentrations in individual exhaust air streams, these may have to be treated before being admitted to the biofilter. pH-relevant exhaust air components such as H_2S and NH_3 can be reduced by water and/or chemical scrubbing to a tolerable level of approximately 5 mg/m^3 for the biofilter media and the microorganisms. Too high a concentration of these exhaust air constituents results in an acidification of the filter media and hence unfavourable environmental conditions for the microorganisms [8, VDI 2008]. To prevent a drop in the pH, the filter media is amended with lime in individual cases [189, VDI 2016].

Removal of pH-relevant components can be accomplished by scrubbers for instance. According to guideline VDI 2433, gas scrubbers using an acidic or alkaline scrubbing liquid, if required with oxidant addition, may be used for pH control. A properly designed chemical scrubber achieves high removal efficiencies for ammonia, hydrogen sulphide, mercaptans and fatty acids [8, VDI 2008].

For monitoring the proper operation of biofilter systems, weekly, monthly or yearly monitoring measures can be implemented [178, TWG 2020]. Thus, it is convenient to carry out a visual inspection and sensory check (odour quality and hedonic tone) of the overall system daily. The sensory check is important to control if process odour is perceptible in the clean gas. Releases of untreated air can be detected by the sense of smell and must be promptly eliminated. The typical odour of the exhaust air of a SA installation is no longer perceptible in the treated air exiting the biofilter. Nevertheless, it is reported that a well-performing biofilter can have a background odour level, comparable to a wet-forest, earthy odour [204, TWG 2021].

The technology is simple and can be operated continuously without constant supervision/attention. Maintenance is simple. It generally just comprises annually loosening and refurbishing the filter medium. A daily visual inspection of the filter medium allows the operator to detect any compaction or the development of preferential channelling of the effluent gas, or signs of erosion by the irrigation water, all of which can reduce abatement efficiency. The retaining walls may be inspected daily for any leaks and damage that could compromise their airtight integrity. Flooding of the subfloor plenum due to inadequate drainage or due to the water table rising may occur and is usually due to improper design or installation.

Biofilters are reported to be suitable for the separation of malodorous substances which result from organic and partly inorganic exhaust air components, such as nitrogen, phosphate, etc.

Achieved environmental benefits

Reduced odour emissions. Used biofilter material may sometimes be used for soil improvement in gardening.

Environmental performance and operational data

Experience from operating practice indicates that satisfactory removal efficiencies are attained at specific space loadings of $0.5 \text{ million ou}_E/(\text{m}^3_{\text{filter media}} \cdot \text{h})$ to $1.5 \text{ million ou}_E/(\text{m}^3_{\text{filter media}} \cdot \text{h})$. For instance, for a normalised flow rate of $100\,000 \text{ m}^3/\text{h}$ and a typical bed depth of approximately 1.8 m , the resulting filter area is around $1\,100 \text{ m}^2$. With such a design, it can be expected that only the filter-specific odour will be perceptible on the biofilter exit side [8, VDI 2008].

To obtain a representative result for the entire area of the biofilter, samples must be collected at several locations with the aid of a sampling hood. The number of sampling locations is governed by the size of the area source and the base area of the sampling hood. Representative sampling of large area sources requires a large number of samples. For example, VDI 2590 requires a minimum of 30 samples for a biofilter with a surface area of $3\,000 \text{ m}^2$ when using a sample hood with a base area of 1 m^2 [8, VDI 2008].

Generally, odour removal efficiencies with the use of a biofilter as a stand-alone abatement technique vary between 70 % and 95 %. This, however, depends on the composition of the feedstock, the inlet concentration, the flow rate, the number of hours in operation and maintenance of the biofilter [204, TWG 2021].

The figures in Table 2.18 show the required biofilter surface areas designed by calculation. These were found to agree with the surfaces of existing unspecified biofilters installed in rendering plants, with various raw material throughput, which were actually controlling odour problems.

Table 2.18: Reference values for the size and rating of biofilters

Raw material throughput (t/h)	Required filtration area (m ²)	Volume flow (m ³ /h)
5	250	30 000
10	500	60 000
20	1 000	120 000
50	2 500	300 000
Source: [203, VDI 1996]		

For pasteurised worm compost inoculated with a selected *Pseudomonas* culture, reduced odour emissions with an efficiency of approximately 95-98.4 % have been reported. This filter material is reported to be suitable for most types of ventilation air. This medium is used in an example fishmeal and fish oil processing plant. The malodorous emissions are extracted from the processing plant, including from places where the highest intensity odours are produced such as the cooker. Fish is processed at a rate of 15 t/h, producing condensate at a rate of 0.258 t/t fish, i.e. 3.87 t/h of exhaust vapour. A total of 60 % goes to the WWTP and 40 % evaporates, to produce 1.55 t/h of exhaust vapour [130, COM 2005].

In the example plant, before the air is transferred to the biofilter it undergoes some initial purification by passing it through water. This separates out some fats and solids. The biofilter applied has a surface area of 800 m² handling air at a rate of 100 000 m³/h, with a consequent surface load of 125 m³/h per square metre and an annual operating time of 500 h/yr. It works at full load for 60 % of the time and part load for the remainder. The filter bed height is approximately 0.8 metres and the residence time of the malodorous air is approximately 15-20 s. During this time, the malodorous organic components of the exhaust air are organically disintegrated by microorganisms, which include bacteria and fungi. Individual components of the malodorous air have been measured and reductions in total carbon, ammonia and other nitrogen compounds detected [130, COM 2005].

In Table 2.19 some odour emission values from when a biofilter is used as an abatement technique in various non-slaughterhouse installations are presented.

Table 2.19: Odour emission values (ou_E/m³) when a biofilter is used as an abatement technique in non-slaughterhouse installations

Emission point	Odour value (ou _E /m ³)	Average air flow (Nm ³ /h)	Comments
AT013_{2}	136	17 783	In combination with wet scrubber
AT014_{2}	280	18 000	In combination with wet scrubber
BE027_{1}	165	-	In combination with wet scrubber
DE075_{1}	300	95 000	-
DK087_{3}	448	26 433	-
FR236_{1}	340	47 110	In combination with wet scrubber

Emission point	Odour value (ou _E /m ³)	Average air flow (Nm ³ /h)	Comments
FR246_{2}	2 135	76 227	In combination with wet scrubber
FR248_{1}	1 000	200 000	In combination with wet scrubber

Source: [178, TWG 2020]

In 2014, a chicken slaughterhouse in Austria reported odour emissions of 287 ou_E/m³ from a biofilter consisting of three closed biofilters (container) which are connected in series. Overall, the biofilter unit has a capacity of 25 000 m³/h and the filter medium is bark mulch [113, Waxwender et al. 2016].

Depending on its composition and the specific application, biodegradable filter media has a service life of about 1 to 5 years. Media mixtures containing elevated inert fractions may have a considerably longer service life. Frequently, the complete media bed is replaced when the performance of the biofilter declines. Here, on-site regeneration may be a more cost-effective alternative [189, VDI 2016].

Broken pallets can be used as a filter medium and it is reported that such spent filter material from a bone de-fatting plant is used as compost in gardens.

Bark can be used as a filter medium. One supplier of bark as a biofilter medium to a gelatine manufacturing plant recommends that the bark is replaced every 3 or 4 years, but this is done annually by an example plant operator.

LECA is used as a filter medium in rendering plants. The supplier of the LECA recommends that it is periodically sterilised and re-inoculated with microorganisms. One user with two plants reports that this has been unnecessary and that odour reduction efficiencies of 99 % have been achieved. A thermal oxidiser is also used for odour abatement in at least one of these plants.

Peat and heather supported on seashells can also be used as a filter medium. The peat and heather provide the growing medium on which the microorganisms grow. The shells support the medium, which would otherwise compact, thereby removing the need to periodically mix it to re-establish the growth of the microorganisms.

Fired earth of a defined particle size is both self-supporting, i.e. it does not compact and does not biodegrade, and it presents a surface area capable of supporting the biodegradation of malodorous emissions.

Cross-media effects

Spent filter media from biofilters can normally be used as a soil improver in landscaping applications which may, however, require a pH adjustment of the filter material by lime addition [8, VDI 2008]. The used biofilter can sometimes be used as compost, but most of the time it has to be disposed of as waste, e.g. by incineration.

Leachate which seeps through the biological filtration system and waste water generated from the blowdown require waste water treatment.

Any leachate produced can contain organic residues of the filter material.

Energy is consumed during the transfer of the malodorous air to and through the biofilter. Filter bed dry-out should be counteracted by providing for additional irrigation of the filter media. The electricity consumption is 30 000 kWh/year for a biofilter of 78 m² installed in a pig slaughterhouse (FI146) to treat air from the WWTP [178, TWG 2020].

The biofilter may be an odour source. It has been reported that emissions of N₂O, which is a greenhouse gas, may be a problem.

All biofilters exhibit a specific odour which is of biogenic origin. The higher the microbial density of the biologically active media, the higher the biogenic odorant concentrations released will be [189, VDI 2016]. The natural wood filter media of biofilters may be associated with a slight forest floor or wood smell that is caused by VOC-like terpenes [211, TWG 2023].

There may be problems due to noise from the fans used to transfer malodorous air to the biofilter.

There may be occupational health hazards associated with personnel entering the biofilter to visually inspect the filter medium and to water it. Remote watering systems may be provided.

Technical considerations relevant to applicability

Biofilters are applicable in SA installations, but they are not suited to combustion gas treatment. It has been reported that peaks of malodorous non-condensable gases may not only pass through a biofilter without any significant reduction, but they may also be inhibitory to the biological activity in the medium. Biofilters are, therefore, considered to be suitable for high-volume low-odour-intensity air streams only, as they do not achieve 100 % odour destruction.

The requirement for a large surface area may be prohibitive if space availability is limited. Small standard modules can, however, be used for local exhausts.

Economics

The initial capital costs and running costs are relatively low. Investment costs of EUR 5 000-20 000 for a biofilter treating 1 000 Nm³/h have been reported. Nevertheless, the running costs of biofilters (especially when high air volumes are treated) are generally significant [204, TWG 2021].

For the fishmeal and fish oil processing case study above, the following costs have been quoted:

2 x 58 kW exhaust fans, operating for 3 000 h/yr x EUR 0.065/kWh = EUR 22 620

2 x 23 kW exhaust fans, operating for 2 000 h/yr x EUR 0.065/kWh = EUR 5 980

2 x circulating pumps for the scrubber = EUR 4 875

Treatment of 60 % of the condensate in the WWTP = EUR 39 000

The filter material is changed every 4 years = EUR 14 000/yr

Maintenance = EUR 7 000/yr

Overall annual cost EUR 93 475

The electricity cost is EUR 3 000/year and the maintenance cost is EUR 500/year for a biofilter of 78 m² installed in a pig slaughterhouse (FI146) to treat air from the WWTP. The filter is able to treat 9 000 m³/h of air and its size is 78 m². [178, TWG 2020].

Driving force for implementation

Reduction of odour emissions.

Example plants

Widely used in the SA sector.

Reference literature

[8, VDI 2008], [203, VDI 1996], [23, Nordic 2001], [29, Germany 2001], [60, United Kingdom 2002], [61, Belgium 2002], [108, Clitravi - DMRI 2003], [62, Germany 2002], [113, Waxwender et al. 2016], [121, Giner-Santonja et al. 2019], [178, TWG 2020], [189, VDI 2016], [204, TWG 2021].

2.3.8.2.9 Adsorption

Description

Organic compounds are removed from a waste gas stream by retention on a solid surface (typically activated carbon).

Technical description

Adsorption is a unit process involving the capture of airborne components on a fine particulate active surface. There are a number of possible active materials that are used for general applications, including zeolites, silicas, polymeric resins and activated carbon. Activated carbon is the most frequently chosen adsorbent within the SA sector, hence the term carbon adsorption is commonly used.

Carbon adsorption is a dynamic process in which vapour molecules impinge on the surface of the solid and remain there for a period of time before desorbing again into the vapour phase. An equilibrium is established between adsorption and desorption, i.e. a particular concentration of a compound on the carbon surface corresponds to a concentration or partial pressure of that compound in the gas phase.

Activated carbon has been used for odour abatement for many years. The effect is based on the very large specific surface area, in the form of micropores, which bind the odour molecules. The larger the molecules, the better the binding. Neither ammonia nor hydrogen sulphide are bound effectively. The efficiency for hydrogen sulphide for example can, however, be improved by using specially prepared carbon. As the pores are filled, the efficiency falls and the carbon must be either replaced or regenerated.

Achieved environmental benefits

Reduced odour emissions.

Environmental performance and operational data

The efficiency of new carbon preparations is 95-98 %, but it drops over time, so the average efficiency during the life cycle of the activated carbon is considerably lower, possibly nearer to 80 %. Water, dust and fat aerosols can ruin an activated carbon filter. The relative humidity must therefore not exceed 80-90 % and particles must be effectively removed upstream of the filter.

The rendering installation FR243 applies activated carbon as a stand-alone abatement technique to treat waste streams from raw material reception and skin removal areas. An average air flow rate of 50 000 Nm³/h has been reported. Three fishmeal and fish oil installations reported an air flow rate ranging between 3 720 Nm³/h and 12 310 Nm³/h [178, TWG 2020].

The rendering installation IT166 implemented a carbon filter in 2019 to deodorise the air vented from a finished product silo. Vents are activated during the loading of the silos to avoid overpressures. Measurement of the outlet air of the vents before the filter showed an odour concentration of about 19 500 ou_E/m³, and a concentration of 205 ou_E/m³ after the filter (99 % removal efficiency) [178, TWG 2020].

The activated carbon filter applied in a pig slaughterhouse to reduce odour emissions from the blood tank has a capacity of 36 000 m³/h [113, Waxwender et al. 2016].

For reducing odour emissions from the flotation unit and certain production steps, an activated carbon filter with a capacity of 4 250 m³/h was installed in a pig slaughterhouse [113, Waxwender et al. 2016].

It has been reported that in Danish slaughterhouses adsorption techniques are used mainly in processes relating to by-product handling with small air flows (blood storage, manure storage, truck loading, etc.) [204, TWG 2021].

Technical considerations relevant to applicability

The technique is applicable in all SA installations, providing the air is dry and does not contain dust or aerosols.

Economics

Can be expensive to maintain and replace.

Driving force for implementation

Reduced odour emissions.

Example plants

Used in slaughterhouses of pigs and cattle, in rendering plants of ABP Category 1, in a fishmeal and fish oil installation [178, TWG 2020].

Many Danish slaughterhouses and rendering plants.

Reference literature

[23, Nordic 2001], [106, Germany 2003], [113, Waxwender et al. 2016], [121, Giner-Santonja et al. 2019], [178, TWG 2020].

2.3.8.2.10 Condensation

Description

The removal of vapours of organic and inorganic compounds from a process off-gas or waste gas stream by reducing its temperature below its dew point so that the vapours liquefy.

Technical description

High-intensity cooking vapours can be passed through a condenser(s) to separate condensable and non-condensable gases. Where this is done, the non-condensable gases are passed for further abatement and the condensate is either treated on site in a waste water treatment plant or at an off-site plant for treatment.

The configuration of condensers / boiler and WWTP for treating cooking vapours has equal merits from an environmental perspective to treating them in a thermal oxidiser and the decision is normally dependent on whether a WWTP is available on site.

Condensate has very high chemical oxygen demand and ammonia concentration, so it must be fed into a WWTP in a controlled manner so as not to overload the plant. There is potential to recover energy from the high COD condensate by anaerobic treatment to produce methane for renewable energy purposes. However, this is dependent on the ammonia loading, which could inhibit the AD process.

Condenser systems may be an essential step if the primary abatement system consists of burning the non-condensable gases in multiple boiler(s) and/or thermal oxidisers. They may also provide backup to primary combustion abatement plants such as thermal oxidisers. Under these circumstances, the backup condensers may feed into a boiler which operates as a secondary abatement system. In both scenarios, the cooking process can be stopped in a controlled manner if the primary abatement plant goes offline.

High-efficiency condensers can improve condensing performance and the residual air may be suitable for abatement in a biofilter or chemical scrubber rather than using energy-intensive thermal oxidation. Chilled condenser units are in use in other sectors and this technology may be an option for the EU ABP sector to consider as an emerging technique.

Condensation is a technique that eliminates water vapours from a waste gas stream by reducing its temperature below its dew point. Condensation is carried out by means of direct cooling (i.e.

contact between gas and cooling liquid) or indirect cooling (i.e. cooling via a heat exchanger). Indirect condensation using basically water or ambient air is preferred because direct condensation needs an additional separation stage. Recovery systems vary from simple, single condensers to more complex, multi-condenser systems designed to maximise energy and vapour recovery.

In some cases, it is reported that condensation is not applied due to local conditions. In particular, it is reported that the possibility of discharging waste water (after the condensation stage) is limited due to the quantity of water produced or the distance to a potential receiving water body (e.g. in some regions in France) [178, TWG 2020].

A more detailed technical description of condensation can be found in the CWW BREF [154, Brinkmann et al. 2016].

Achieved environmental benefits

Odour reduction.

Environmental performance and operational data

Condensation is typically applied in rendering plants where high-intensity cooking vapours are passed through a condenser(s) for condensable and non-condensable gases separation. Afterwards the non-condensable gases are passed for further abatement and the condensate is either treated on site in a waste water treatment plant or at an off-site plant.

A condensation unit is implemented in a rendering installation (IT163) after the combustion of malodorous gases in an existing boiler. It is a classic spiral condenser: the air from the burner enters the hot side and is cooled down by a glycol solution recirculating in the cold side in a closed loop. The hot air is cooled from around 200 °C to about 50 °C and, in doing so, water is condensed; the cold glycol enters the condenser and receives the heat from the air; the glycol, now hot, leaves the condenser and is sent to three air coolers installed on the roof. Here the heat is transferred from the glycol to the environment, and the now cooled glycol is sent to the condenser again, closing the loop (see Figure 2.43).

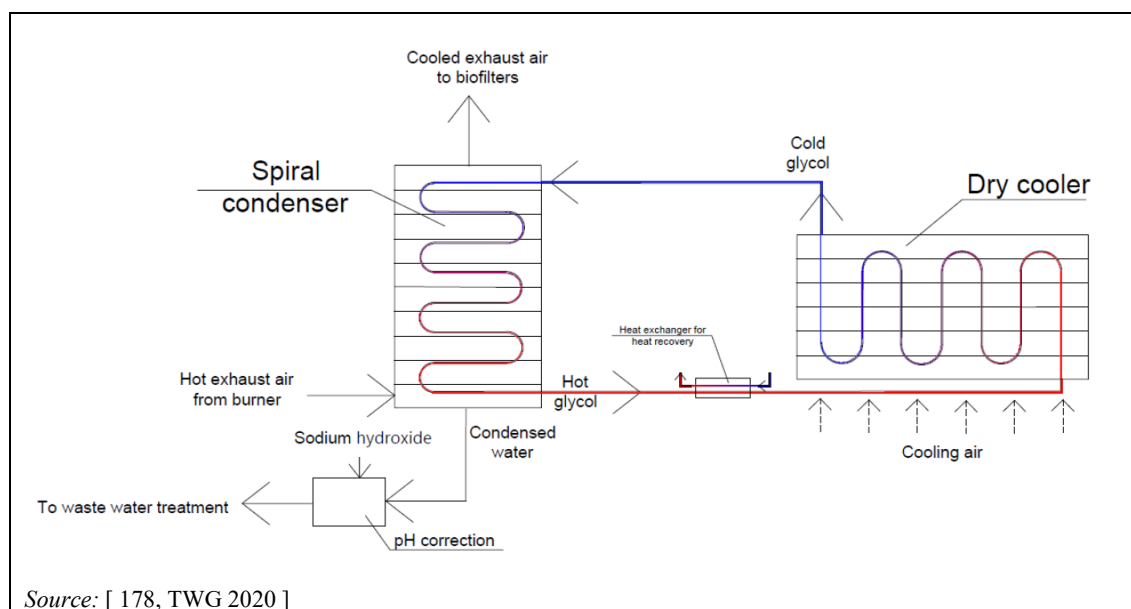

Figure 2.43: Scheme of a condensation unit

Technical considerations relevant to applicability

Generally, there are no technical restrictions to the applicability of this technique.

Cross-media effects

Production of waste water.

Economics

Condensation is usually a low-cost technique. Nevertheless, electricity costs for chilled condensers are high, compared to air-cooled or water-cooled condensers [204, TWG 2021].

The economic costs associated with the condensation unit implemented in installation IT163 are EUR 97 850 for the spiral condenser; EUR 92 150 for the dry coolers; EUR 11 000 for the exhaust air extractor (from burner to condenser); and EUR 155 000 for the supporting structure for dry coolers and glycol loop pipes and pump [178, TWG 2020].

Driving force for implementation

Legislation related to odour emissions.

Example plants

IT163.

Reference literature

[154, Brinkmann et al. 2016], [178, TWG 2020].

2.3.8.2.11 Wet scrubber

Description

The removal of gaseous or particulate pollutants from a gas stream via mass transfer to a liquid solvent, often water or an aqueous solution. It may involve a chemical reaction (e.g. in an acid or alkaline scrubber). In some cases, the compounds may be recovered from the solvent.

Technical description

The concentration of malodorous substances in waste gases can be reduced by means of a waste gas scrubbing process using a scrubbing fluid (absorption agent). The absorption of a substance by the scrubbing fluid is a balance reaction which depends on the solubility and vapour pressure of the substance under the prevailing temperature and pressure conditions; the contact area; the residence time and the ratio of the gas flow rate to the liquid flow rate. The process can be optimised by atomising the scrubbing fluid and by coating absorbers on support material to maximise the surface area exposed.

Water is frequently used as a preliminary scrubbing fluid to remove dust and droplets of fat, which could otherwise interfere with the activity of the absorbent, as well as to remove some of the nitrogenous compounds. The use of water alone, even in several stages, is not sufficient to reduce odour emissions to acceptable levels. Seawater can also be used for scrubbing of waste gas streams in fishmeal and fish oil plants.

While the addition of chemicals to the scrubbing liquid improves the removal of exhaust air constituents like ammonia, hydrogen sulphide, mercaptans and fatty acids, the removal efficiency for odour compounds normally remains limited to approximately 80 %. It is, therefore, usually followed by exposure to acid or alkali oxidising streams.

Gas absorbers are essentially gas-liquid contacting devices where vapours and gases are absorbed from a contaminated exhaust stream into chemical solutions. This liquid phase is generally recirculated, with a small quantity being continually bled off and an equal amount of fresh reagent being added. Malodorous pollutants are absorbed into appropriate chemical solutions.

An alternative or complementary technique to burning malodorous rendering gases is to pass the outlet air and water through a recirculating scrubber system. In this case, the scrubber water can be treated with a chemical oxidant to remove offensive contaminants, such as H₂S, mercaptans

and ammonia-based compounds, such as amines. Chlorine dioxide is effective as a chemical oxidant for controlling decomposition products generated from rendering operations, i.e. products formed by the action of putrefactive bacteria on nitrogenous matter.

Wet scrubbers can be used as a stand-alone abatement technique, but are frequently implemented as a pretreatment step before biofilters in rendering plants [113, Waxwender et al. 2016], [155, Karlis et al. 2019]. The scrubber effluents discharged to the waste water treatment plant should be monitored for a compatible pH.

Achieved environmental benefits

Odour reduction.

Environmental performance and operational data

For efficient and cost-effective absorber operation, the pH of the scrubbing liquid is always adjusted to either the acidic or alkaline range [181, VDI 2020].

A wet scrubber is composed of a vertical tower 18 m high with a first acid stage (use of H₂SO₄) and a second basic stage (use of NaOH) with capacity of 120 000 Nm³/h. The scrubber treats room air of a rendering activity (IT176) and some of the process air. During 2019, the electricity consumption was 7 kWh/tonne of raw material, the consumption of chemicals was 1.5 kg/tonne of raw material, and the consumption of fresh water was 0.04 m³/tonne of raw material [178, TWG 2020].

Data on the use of wet scrubbers in combination with biofilters for the reduction of odour emissions in non-slaughterhouse installations can be found in Table 2.19.

Cross-media effects

Waste water is generated. Generally in installations there is inadequate separating capacity and a lack of suitable means of feedback control for the metering of chemicals. The use of oxidants can lead to the formation of malodorous compounds and poor liquid effluent management and can create a secondary odour source.

Technical considerations relevant to applicability

Generally, there are no technical restrictions to the applicability of this technique.

Economics

The installation cost of a wet scrubber with the capacity to treat 120 000 Nm³/h of air in a rendering plant (IT176) in 2018 was approximately EUR 800 000 [178, TWG 2020].

The cost-effectiveness of absorbers is reduced if the exhaust gas to be treated has a high moisture content, due to their preferential absorption of water vapour.

Driving force for implementation

Reduction of odour emissions.

Example plants

IT176.

Reference literature

[8, VDI 2008], [203, VDI 1996], [60, United Kingdom 2002], [178, TWG 2020], [121, Giner-Santonja et al. 2019], [155, Karlis et al. 2019], [181, VDI 2020].

2.3.8.2.12 Bioscrubber

Description

A packed tower filter with inert packing material which is normally continuously moistened by sprinkling water. Air pollutants are absorbed in the liquid phase and subsequently degraded by microorganisms settling on the filter elements.

Technical description

Bioscrubbers, also known as biotrickling filters, work through the microbial decomposition of air pollutants absorbed in the scrubbing medium. The absorbent is a scrubbing medium containing a high concentration of microorganisms, such as activated sludge. The bioscrubber can be operated in several stages, using absorbents of different pH values to absorb components of differing chemical composition, thereby achieving decomposition to as great an extent as possible.

The microorganisms can also be established as a filter film on built-in elements or on packing, i.e. trickle bed reactors.

Nutrients for the microbes are added to the absorbents in controlled quantities.

Achieved environmental benefits

Can reduce odour emissions by 70-80 %.

Environmental performance and operational data

The gas to be treated is passed countercurrent against a flow of water containing a population of microbes suitable for oxidising the malodorous pollutants. The treatment is undertaken within a 'tower' containing a packing medium on which the microbial growth is supported. Bacteria from activated sewage sludge can be used to seed the packing. The water is circulated through the absorber and nutrients are added as required. The pH and nutrient balance are particularly important to prevent biomass from accumulating within the packing and causing a reduced circulation and flow and ultimately a blockage, if not periodically removed.

Fluctuations in the conditions of the air streams can have a large impact on the performance.

The performances in Table 2.20 have been reported.

Table 2.20: Reported performance data for a biotrickling installation

Pollutant	Concentration at 15-40 °C and atmospheric pressure	Performance (% removal)
Volatile organic compounds	400-1 000 mg/m ³	80-95
Odour	> 20 000 ou _E /m ³	70-90
H ₂ S	50-200 mg/m ³	80-95
NH ₃	100-400 mg/m ³	80-95
Mercaptans	5-100 mg/m ³	70-90
<i>Source: [130, COM 2005]</i>		

A bioscrubber in combination with a biofilter was used to treat emissions to air from the WWTP in a chicken slaughterhouse installation (DE047). An average odour emission value of 67 ou_E/m³ was reported for an average air flow of 10 935 Nm³/h. A bioscrubber in combination with a biofilter was used to treat process air emissions from a non-slaughterhouse (rendering, fat melting and blood processing) installation (DK085). An average odour emission value of 877 ou_E/m³ was reported for an average air flow of 70 333 Nm³/h [204, TWG 2021].

Cross-media effects

The requirement for water and air to be circulated makes this abatement technique relatively energy-intensive.

Sludge is produced, which then needs to be thickened, dehydrated and removed. The waste water produced needs to be sluiced to prevent scaling and to prevent it from inhibiting microbiological activity.

Technical considerations relevant to applicability

Unsuitable for toxic and high concentrations of acidifying substances. The technique is not suitable for very poorly soluble components.

Economics

Investment costs of EUR 5 000-15 000 for a biofilter treating 1 000 Nm³/h have been reported. Running costs are relatively high, due to the energy requirements for the water circulation.

Driving force for implementation

- Reduction of odour emissions.
- Meeting H₂S emission requirements.

Example plants

A rendering plant in Denmark.

Reference literature

[60, United Kingdom 2002], [61, Belgium 2002], [70, Tauw 2000], [121, Giner-Santonja et al. 2019], [181, VDI 2020].

2.3.8.2.13 Thermal oxidation**Description**

The oxidation of combustible gases and odorants in a waste gas stream by heating the mixture of contaminants with air or oxygen to above its auto-ignition point in a combustion chamber and maintaining it at a high temperature long enough to complete its combustion to carbon dioxide and water.

Technical description

For complete oxidation of the compounds to be degraded in the air stream, it is necessary for them to be in contact with sufficient oxygen for a long enough time and at a high enough temperature. Rapid oxidation of organic compounds will occur if the gas temperature in the thermal oxidiser can be maintained at 200-400 °C higher than the auto-ignition temperature of the chemical species present. In thermal oxidation, the pollutant conversion takes place at high temperatures, e.g. > 600 °C. Thermal oxidisers do not operate effectively until they reach the combustion temperatures of the pollutants they are used to destroy, so they need to be started up before they are actually required [121, Giner-Santonja et al. 2019].

Direct flame thermal oxidisers usually operate at temperatures of between 700 °C and 900 °C. The reaction temperature depends on the nature of the pollutant. For odorous compounds, a temperature of 750-850 °C is generally adopted [121, Giner-Santonja et al. 2019]. Moreover, it has been reported that an effective combustion of odorous emissions is generally achieved if the air flow is maintained at a sufficiently high temperature (typically in the range of 750-850 °C) with a sufficient residence time (typically between 1 and 2 seconds) [204, TWG 2021].

Achieved environmental benefits

Reduced emissions of low-volume high-intensity and high-volume low-intensity odours to almost 100 % efficiency and the elimination of all vapour, thus removing the need for it to be treated in the WWTP.

Environmental performance and operational data

Generally it is the concentrated process gases that are incinerated, particularly those containing non-condensable gases. Complete combustion must be achieved, as partially oxidised organic matter might still produce malodorous substances. The effective destruction of malodorous emissions is achieved by paying particular attention to the temperature in the combustion chamber, typically in the range of 750-850 °C, with a sufficient residence time (typically between 1 and 2 seconds) and employing turbulence/mixing and sufficient oxygen.

The sizing of the combustion chamber is important. The combustion chamber length and design are determined by the length of the flame and the requirement to achieve the required residence time and effective mixing of the gas stream with combustion air. Process gases and vapours are extracted directly from the cooker and meal presses and conveyed, via stainless steel pipework, to a collector. Dropout pots situated within the pipework remove any air-entrained solid matter within the gas stream.

Room air from other malodorous areas may also be extracted, after first being filtered to remove entrained particulate matter. It may then be preheated by an economiser and used as combustion air within the combustion chamber.

Operation of the thermal oxidiser is managed by a PLC control system. Temperature is continuously measured in the combustion chamber and variable speed fans ensure balanced rates of combustion, extraction of process gases and steam production. There is a strong relationship between the thermal destruction requirement and the demand for steam. This includes steam venting arrangements at process shutdown and the provision of steam during periods of process start-up and downtime return.

During thermal oxidation, the objective is to completely oxidise the combustible gases. This leads to the production of pollutants such as CO₂, NO_x and possibly SO₂ and/or chlorides, plus water.

As the process destroys all of the odour from the cookers, including by destroying the non-condensable gases, the need to provide an alternative means of disposal or to treat a highly malodorous effluent is removed. If, in addition, waste water is also subject to thermal destruction, the generation of liquid effluent is greatly reduced and even potentially removed.

The achievable emission levels of any installation are affected by baseline combustion conditions pertaining to the fuel being used and the character of the process gas needing to be destroyed. Additional levels of substances such as NO_x arise from the destruction of substances present in the process air fed into the combustion chamber. The principal factor affecting the magnitude of NO_x releases is the level of NH₃ present in the process gases, which is directly related to the storage history of the raw material prior to the rendering. In order to minimise releases of ammonia and NO_x, some degree of control over the raw material storage, handling and transfer at the source and at the animal by-products installation can ensure that the materials are processed in as fresh a state as possible.

A waste heat recovery boiler integrally connected to the thermal oxidiser can use heat from the combustion gases to provide steam for use in the cooking/rendering operation.

There is some opposition to the use of this technique on the grounds of high energy consumption and capital expenditure, which may limit the feasibility of this technique to small quantities of air and/or heavily polluted air.

In Table 2.21 some odour emission values from when a thermal oxidiser is used as an abatement technique in rendering installations are presented.

Table 2.21: Odour emission values (ouE/m³) when a thermal oxidiser is used as an abatement technique in rendering installations

Emission point	Odour value (ouE/m ³)	Removal efficiency (%)	Average air flow (Nm ³ /h)
FR246 {6}	380	99.96	18 807
FR250 {1}	784	-	11 736
IT158 {5}	270	-	4 353
ES139 {1}	813	-	23 533
BE025 {2}	3 859	99	-
ES136 {1}	6 518	99.30	15 900
<i>Source: [178, TWG 2020]</i>			

A series of eight odour emission measurements in 2021 have been provided for rendering installation DK087. Non-condensable gases with an approximate flow of 20 000 Nm³/h were treated in a thermal oxidiser. The reported emission values were between 1 000 ouE/m³ and 5 000 ouE/m³ [204, TWG 2021].

Cross-media effects

A feature of combustion systems is that they produce the greenhouse gases CO₂ and NO_x and can give rise to SO_x emissions.

The amount of NO_x emitted may be high if the raw materials are not fresh (and typically Category 1 material is often more degraded than Category 3), especially in warm weather if degradation is not first prevented, i.e. by the rapid treatment or preservation of raw materials for example by cooling.

Emissions of SO_x may be high in cases of feather processing [211, TWG 2023].

Fuel is required to run the thermal oxidiser.

Technical considerations relevant to applicability

Equipment suppliers have concluded that the system is most suited for conventional rendering systems which do not use waste heat evaporators or similar heat recovery systems.

Economics

Equipment suppliers have calculated investment and running costs for such a system built into various conventional systems. Their calculations are shown in Figure 2.44. The economy of the system is reported to be substantially improved if new investments in a conventional boiler, condensing unit and waste water treatment plant can thus be avoided.

Figure 2.44 shows comparative costs for three different rendering processes replacing their existing boiler with a thermal oxidation system. In each case the thermal oxidiser is designed to cope with the whole vapour, including the non-condensable gases and a proportion of room extraction air from the process, and to provide 100 % of the steam required by the process. The information is referenced to a throughput of 12.5 t/h of raw material, comprising 25 % dry solids, 12 % fat and 63 % water.

The total cost given is the additional annualised cost of running the thermal oxidiser system compared with retaining the existing system of steam raising boiler, condenser system and waste water treatment system. It is made up of the elements shown in Table 2.22.

Table 2.22: Cost elements for replacing an existing boiler with a thermal oxidiser

Element name	Definition
Investment	The capital cost of the new thermal oxidiser
Extra fuel	The additional fuel required by the thermal oxidiser, compared to that required by the existing boiler, to process those vapours that would not be processed by the boiler
Waste water saved	The amount of process vapour that is no longer condensed, but passes directly to the thermal oxidiser
Capital cost	The investment cost annualised over a 4-year period with an interest rate of 5 %
Fuel cost	The annualised cost of the extra fuel based on an oil price of EUR 200/t
Waste water	The savings in effluent treatment/disposal costs of the vapour that is no longer condensed, based on a waste water treatment cost of EUR 2/t

The use of recuperative or regenerative heat recovery systems can improve the efficiency of the process and reduce the running costs. The comparative costs of the thermal oxidation system can also be improved if its installation prevents the need to invest in new, or replacement, boiler plant, condensers or waste water treatment facilities.

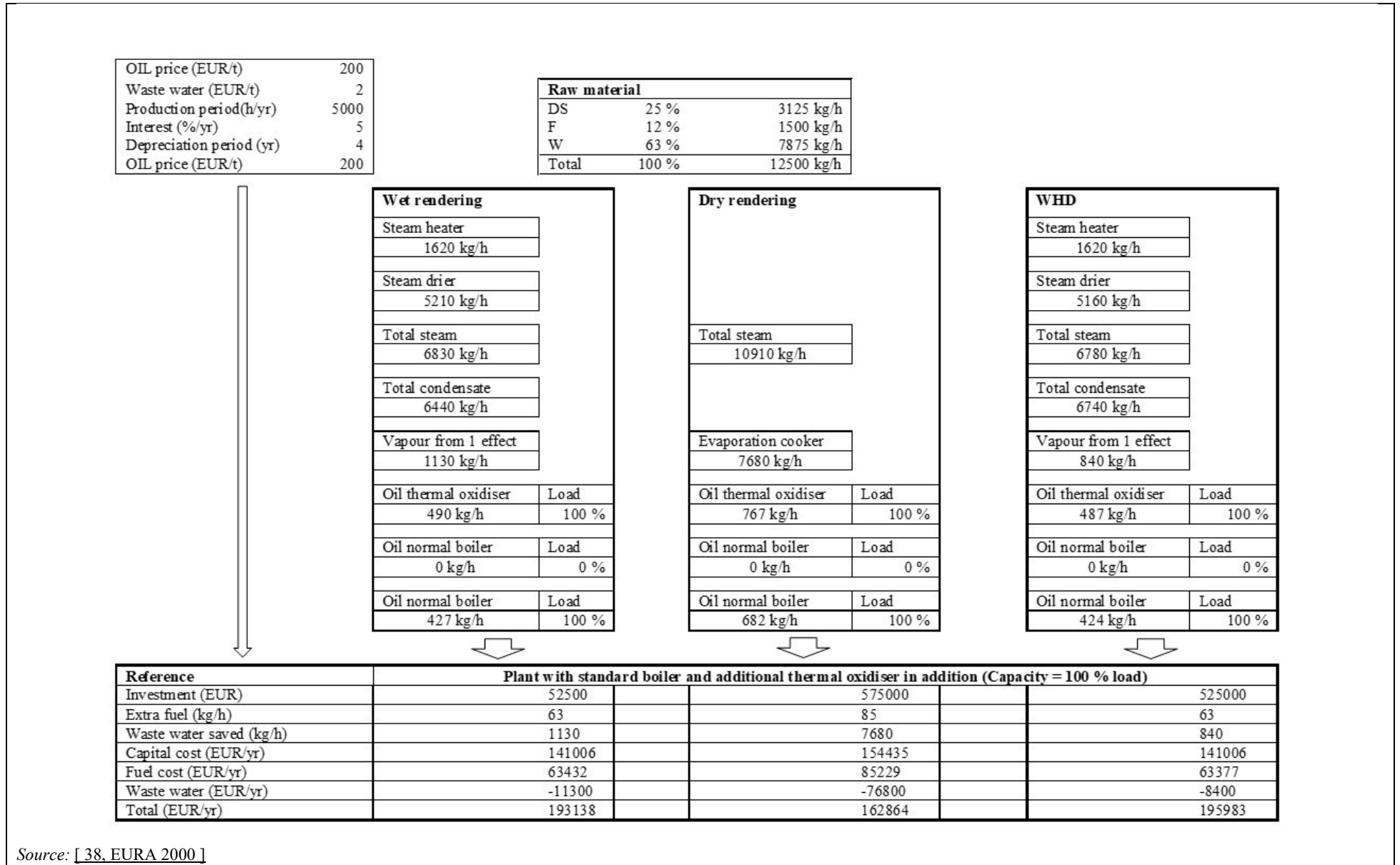

Figure 2.44: Consumption, emission and economic data for a thermal oxidiser for the combustion of vapour, non-condensable gases and room air in rendering

Driving force for implementation

Elimination of intense malodorous gases, especially the non-condensable gases produced during rendering.

Example plants

The technique is widely used in rendering plants across the EU [156, TWG 2019].

Reference literature

[23, Nordic 2001], [32, Sweeney L. 2001], [38, EURA 2000], [60, United Kingdom 2002], [95, Oberthur R. 2002], [121, Giner-Santonja et al. 2019], [156, TWG 2019], [204, TWG 2021].

2.3.8.2.14 Combustion in a steam boiler of malodorous gases, including non-condensable gases

Description

Malodorous gases, including non-condensable gases, are burned in a steam boiler in the installation.

Technical description

Steam collected from cookers, dryers and evaporators is first passed through a cyclone, to separate out the solid material. It then passes through a condenser, in which the process vapours are cooled. The moist air is then dewatered. The water is discharged to a WWTP and the air containing the malodorous substances, including air from the premises, is finally burned.

In some cases, non-condensable gases from the process are burned in a boiler, the waste gas from the boiler is consequently condensed and the non-condensable gas passed through a biofilter [156, TWG 2019] [178, TWG 2020].

Achieved environmental benefits

Reportedly highly efficient and, if properly operated, as efficient at eliminating odours, including intense odours, as other burning methods.

Environmental performance and operational data

If the installation does not have a boiler capable of running continuously to burn the malodorous gases in places where there is a demand for abatement, an alternative treatment system may be required. The flow rate needs to be controlled to ensure complete combustion of the malodorous gases.

A fishmeal /fish oil installation (DK092) reported an odour emission value of 890 ou_E/m³ after treatment of process gases in a boiler. The removal efficiency was 99.7 % and the average gas flow 10 250 Nm³/h. In another fishmeal/fish oil installation (NO280), an odour emission value of 3 523 ou_E/m³ was reported for an average gas flow of 2 870 Nm³/h [178, TWG 2020].

Cross-media effects

Fuel consumption is raised slightly, due to reduced boiler efficiency. It may be necessary to keep the boiler running during rendering, even when there is no demand for steam; otherwise, strong odours may escape, e.g. via a biofilter, which may be only capable of treating low-intensity odours. Keeping the boiler running incurs an additional fuel use.

Indirectly fired hot air dryers are used in Norway as well as other countries to produce so-called LT meal, which is a high-quality low-temperature-dried fishmeal. The flue-gas from the combustion has too high a temperature for the operation of the dryers. A measure to reduce the temperature of the flue-gas is to operate the burner with a significantly higher excess of air than, for example, conventional steam boilers. Typical air excess in the burner of the indirect hot air dryer is 8-12 %, which is three to four times higher than in conventional steam boilers, resulting

in higher formation of nitrogen oxides than from conventional boilers not burning nitrous gases [190, European Fishmeal 2020].

Technical considerations relevant to applicability

Applicable to low-volume high-concentration odours generated in SA installations. Some boilers are designed for this purpose.

Economics

Energy use is reduced by heat recovery. The running costs can be reduced if the inevitable reduction in boiler efficiency can be minimised and provided that the installation is properly designed and built to minimise the effects of the corrosive gases treated.

Driving force for implementation

Reduction in odour emissions.

Example plants

The technique is widely used across the EU [156, TWG 2019].

Reference literature

[97, Biosphere Refineries Corporation 2002], [31, Greek Ministry for the Environment 2001], [40, Widell S. 2001], [108, Clitravi - DMRI 2003], [102, The Netherlands 2003], [156, TWG 2019], [178, TWG 2020], [190, European Fishmeal 2020].

2.3.8.3 Techniques to reduce dust emissions

2.3.8.3.1 Bag filter

For more information, consult the FDM BREF [121, Giner-Santonja et al. 2019].

Description

Bag filters, often referred to as fabric filters, are constructed from porous woven or felted fabric through which gases are passed to remove particles. The use of a bag filter requires the selection of a fabric suitable for the characteristics of the waste gas and the maximum operating temperature.

Technical description

Bag filter or fabric filter systems work by passing air containing particulates through a filter medium which traps the particles as the air is forced through it. The process takes place inside filter units which are placed in the flow of the air to be filtered. To maintain the efficiency of filter media, they are cleaned at regular intervals either by being vigorously shaken or by a reverse jet of air being blown through them to release any material held on the filter - this material is then collected and reused in the production process. It is necessary to change the filter media regularly to ensure that they remain efficient and that there are no microbiological risks to the installation resulting from accumulation of material on the filter media.

Achieved environmental benefits

Reduction of dust emissions to air.

Environmental performance and operational data

Bag filters may reduce dust emissions to $< 5 \text{ mg/Nm}^3$.

Cross-media effects

Energy consumption. Bag filter material life is limited and creates another waste to dispose of.

Reference literature

[121, Giner-Santonja et al. 2019].

2.3.8.3.2 Cyclone

For more information, consult the FDM BREF [121, Giner-Santonja et al. 2019].

Description

Dust control system based on centrifugal force, whereby heavier particles are separated from the carrier gas.

Technical description

Cyclones use inertia to remove (generally large/coarse) particles from the gas stream by using centrifugal forces, usually within a conical chamber. They operate by creating a double vortex inside the cyclone body. The incoming gas is forced into circular motion down the cyclone near the inner surface of the cyclone tube. A high-speed rotating flow is established within a cylindrical or conical container called a cyclone. Larger (denser) particles in the rotating stream have too much inertia to follow the tight curve of the stream, and strike the outside wall, then fall to the bottom of the cyclone where they can be removed. At the bottom, the gas turns and spirals up through the centre of the tube and out of the top of the cyclone. Particles in the air stream are forced toward the cyclone walls by the centrifugal force of the spinning gas but are opposed by the fluid drag force of the gas travelling through and out of the cyclone. Large particles reach the cyclone wall and are collected in a bottom hopper, whereas small particles leave the cyclone with the exiting gas.

Achieved environmental benefits

Reduction of dust emissions to air.

Reference literature

[121, Giner-Santonja et al. 2019].

2.3.8.4 Techniques to reduce NO_x emissions

2.3.8.4.1 Low-NO_x burners

For more information, consult the LCP BREF [180, Lecomte et al. 2017].

Description

The technique is based on the principles of reducing peak flame temperatures. The air/fuel mixing reduces the availability of oxygen and reduces the peak flame temperature, thus retarding the conversion of fuel-bound nitrogen to NO_x and the formation of thermal NO_x, while maintaining high combustion efficiency. This may be associated with a modified design of the furnace combustion chamber.

Achieved environmental benefits

Reduced NO_x emissions to air.

Technical considerations relevant to applicability

Applicability to existing plants may be restricted by design and/or operational constraints.

Reference literature

[180, Lecomte et al. 2017].

2.3.9 Techniques to reduce noise emissions

2.3.9.1 Noise management plan

Description

A noise management plan is part of the environmental management system of the installation (see Section 2.3.1.1) and includes all of the following elements:

- a protocol containing appropriate actions and timelines;
- a protocol for conducting noise emissions monitoring;
- a protocol for response to identified noise events, e.g. complaints;
- a noise reduction programme designed to identify the source(s), to measure/estimate noise exposure, to characterise the contributions of the sources and to implement prevention and/or reduction measures.

Technical description

Such a plan normally does the following:

- Describes the main sources of noise (including infrequent sources) and the nearest noise-sensitive locations. This description covers the following information for each main source of noise within the installation:
 - the source and its location on a scaled plan of the site;
 - whether the noise is continuous/intermittent, fixed or mobile;
 - the hours of operation;
 - a description of the noise, e.g. clatter, whine, hiss, screech, hum, bangs, clicks, thumps or has tonal elements;
 - its contribution to the overall site noise emission, e.g. categorised as high, medium or low unless supporting data are available.
- Also provides the above information for the operation of infrequent sources of noise (such as infrequently operated/seasonal operations, cleaning/maintenance activities, on-site deliveries/collections/transport or out-of-hours activities, emergency generators or pumps and alarm testing).
- Details the appropriate noise surveys, measurements, investigations (which can involve detailed assessments of sound power levels for individual plant items) or modelling that may be necessary for either new or existing installations taking into consideration the potential for noise problems.
- Describes a protocol for response to identified noise incidents, e.g. complaints.
- Contains appropriate actions to be undertaken and timelines.

Noise levels can be assessed and controlled to ensure that they do not cause annoyance to persons in the vicinity. This can be undertaken in cooperation with the regulatory authorities.

There may be significant stationary and mobile noise sources; those building and ground conditions which may influence noise emissions and the level and duration of each noise source can be mapped.

The consequences of noise from a planned increase in production include increased traffic to/from/at the plant; increased operational times for existing sources and from new stationary sources of noise can be evaluated.

Noise levels in the surroundings of the plant can be calculated. A plan to reduce the noise levels in the surroundings from stationary sources and mobile sources can be prepared.

Meetings with working groups which include the participation of the neighbours can be followed by subsequent implementation of noise-reducing activities. Working groups can continue to meet and review noise prevention and control measures.

Achieved environmental benefits

Reduced noise emissions.

Environmental performance and operational data

The noise characteristics, e.g. the tone, its timing, its duration and its level, can all affect how annoying the noise is and can all be assessed to establish what controls are required.

Legislation controlling noise exposure in the workplace requires noise exposure to be controlled by means other than hearing protection, in the first instance. As a general rule, occupational noise assessments are required where the noise levels are such that people standing 2 metres apart have to raise their voices to be heard. Control of noise levels at source for occupational reasons may, therefore, significantly reduce environmental noise. Noise levels that annoy neighbours may, however, be both below occupational action levels at the ear of the person hearing the noise and/or may be high levels of noise which are not an occupational hazard due to the position, time or duration of the noise.

In an example slaughterhouse, the following action was taken to combat a noise problem. A ventilating exhaust was changed; an awkwardly placed machine room was closed; the frequency control/speed of ventilators, e.g. at condensers, was changed; condenser equipment was changed; heat recuperation from the cooling system was extended and selected sources of noise were shielded. For mobile sources, internal traffic routes were altered and acoustic screens were erected. A dispensation allowing an increased noise level of + 5 dB(A) was arranged for Monday mornings. The total noise emitted from the slaughterhouse was reduced by 12-13 dB(A).

It has been reported that most traffic noises arise from the way the vehicle is driven and that effective noise reduction measures include speed reduction and steady driving. Good planning before the installation is constructed can reduce noise emissions by design. This may include building structures such as embankments and walls and placing roads lower than surrounding land. Noise-reducing road surfaces can be applied, e.g. a mastic asphalt with chippings, is reportedly 2 dB(A) quieter than a rolled asphalt surface and 4 dB(A) quieter than a concrete surface. Open textured asphalt capping, known as 'whispering asphalt', can reportedly reduce noise levels by a further 3 dB(A), but has a much shorter lifetime than other road surfacing materials. It may be possible to construct the access and egress on the side facing away from residential areas for example. The vehicle may also be adapted, e.g. by insulating HGV engines.

Fan noises can be transmitted over long distances, with the higher frequencies tending to die away faster. A roof-mounted fan may, therefore, be modified to produce higher-frequency noise. The connections between fans and ducts or housings can be made using elastic linkages, to minimise noise associated with vibrations.

Cross-media effects

None.

Technical considerations relevant to applicability

The applicability is restricted to cases where a noise nuisance at sensitive receptors is expected and/or has been substantiated.

Economics

No information provided.

Driving force for implementation

Good relations with neighbours and occupational health and safety.

Example plants

Widely applied in SA installations.

Reference literature

[72, Pontoppidan O. 2001], [56, Germany 2002], [88, Environment Agency 2002], [89, Environment Agency 2002], [179, Pinasseau et al. 2018].

2.3.9.2 Noise reduction at source and noise abatement**Description**

Implementation of operational and maintenance techniques, as well as low-noise equipment and buildings.

Technical description

Techniques to reduce noise emissions include:

- appropriate location of equipment and buildings: noise levels can be reduced by increasing the distance between the emitter and the receiver, by using buildings as noise screens and by relocating buildings' exits or entrances;
- operational measures, including techniques such as:
 - i. inspection and maintenance of equipment;
 - ii. closing of doors and windows of enclosed areas, if possible;
 - iii. equipment operation by experienced staff;
 - iv. avoidance of noisy activities at night, if possible;
 - v. provisions for noise control, e.g. during production and maintenance activities;
 - vi. limitation of noise from animals in slaughterhouses (e.g. through careful transport and handling);
- low-noise equipment (including techniques such as low-noise compressors, pumps and fans);
- noise control equipment, including techniques such as:
 - i. noise reducers;
 - ii. acoustic insulation of equipment;
 - iii. enclosure of noisy equipment;
 - iv. soundproofing of buildings.
- noise abatement by inserting obstacles between emitters and receivers (e.g. protection walls, embankments).

Achieved environmental benefits

Reduction of noise emissions.

Environmental performance and operational data

No information provided.

Cross-media effects

None.

Technical considerations relevant to applicability

For existing plants, the relocation of equipment and building exits or entrances may not be applicable due to lack of space and/or excessive costs; noise control equipment may not be applicable due to lack of space.

Economics

No information provided.

Driving force for implementation

Environmental legislation.

Example plants

No information provided.

Reference literature

[179, Pinasseau et al. 2018].

2.3.10 Techniques to minimise the environmental impact of the use of refrigerants

2.3.10.1 Use of refrigerants without ozone depletion potential and with low global warming potential

Description

Suitable refrigerants include for example water, carbon dioxide, propane and ammonia.

Technical description

Refrigerants are widely used in slaughterhouses in cooling, refrigeration and freezing operations. The interaction of halogen refrigerants with ozone in the air has resulted in the progressive prohibition of the placing on the market and use of ozone-depleting substances and of products and equipment containing those substances. These compounds are being substituted by other refrigerants such as carbon dioxide, ammonia, glycol or, in some cases, chilled water.

Hydrochlorofluorocarbons (HCFCs), hydrofluorocarbons (HFCs), chlorine and ammonia are frequently used if the temperatures are below -10 °C. HCFCs have the disadvantage of depleting the ozone layer when released to the atmosphere. They also show considerable global warming potential (GWP). The use of HCFCs is generally prohibited [159, EC 2009]. HFCs have the disadvantage of possessing a much higher GWP than alternative refrigerants such as ammonia, carbon dioxide, propane and water. There are provisions aiming at containing, preventing and thereby reducing emissions of HFCs [158, EC 2014].

The leakage rate for industrial HFC refrigeration systems has been estimated at around 8 %, compared to > 20 % for HCFC-containing equipment. The HFC phase-out under the F-gas Regulation is being implemented by annual quantitative limits (quotas) on the placing on the EU market of HFCs by producers and importers. In 2018, EU-wide placing on the market of HFCs was 1 % below the overall market limit set by the quota system [163, EEA 2020].

Achieved environmental benefits

Reduced risk of ozone depletion and global warming.

Environmental performance and operational data

The use of substances that deplete the ozone layer can be prevented or minimised by:

- using substitutes for such substances;
- when ozone-depleting substances are used, using closed-circuit systems;
- enclosing systems in buildings;
- encapsulating parts of systems;
- creating a partial vacuum in the encapsulated space and preventing leaks in systems;
- collecting the substances during waste treatment;
- using optimised waste gas purification techniques;
- proper management of the recovered substances and the waste.

Ammonia (R717) has been used for industrial refrigeration for a long time. Ammonia refrigeration systems are more costly, especially in the low-capacity range. Besides water (R718) and air (R729), ammonia is the only refrigerant with zero ozone-depleting potential (ODP) and global warming potential (GWP). Due to its excellent thermodynamic properties, ammonia requires less energy than many other refrigerants because it has a great ability to absorb a large amount of heat when it evaporates. Ammonia refrigeration systems have been evolving in recent years. For example, low-charge ammonia cooling systems have been developed that perform optimised ammonia refrigerant charges (less than 0.91 kg/kW) [206, TWG 2022].

Since the year 2000, HCFC-22 has been replaced in new equipment by the HFC refrigerant R404A, first in Europe, then in other industrialised countries. This refrigerant is no longer allowed in new installations from 1 January 2020, due to Regulation (EU) 517/2014, which prohibits the use of fluorinated greenhouse gases with a GWP higher than 2 500. This includes R404A. However, Regulation (EU) 517/2014 identifies some cases in which the prohibition shall not apply until 1 January 2030 [158, EC 2014]. In recent years, a number of cascade systems with ammonia and CO₂ have been installed [157, COM 2011].

Cross-media effects

The risk of ammonia and glycol leaks, which can cause health and safety problems.

Technical considerations relevant to applicability

None.

Economics

Substitution of refrigerants is energy-efficient for industrial cooling systems. Examples of individual abatement costs for the alternative option ammonia (R717) are given in the preparatory study for a review of Regulation (EC) No 842/2006 on certain fluorinated GHG [157, COM 2011].

For a small system with 270 kW cooling capacity at three temperature levels:

- Cost of HFC system: EUR 425 000.
- Additional cost of similar NH₃ system: EUR 132 000 (+31 %).
- Electricity consumption: 1 800 000 kWh/year.
- NH₃: -27 % electricity consumption.
- Operation cost for F-gas system: EUR 100 000 per year.

For a large system with 5 MW cooling capacity:

- Cost of HFC system: EUR 6 million.
- Additional costs for similar NH₃ system: between 0 and 20%.
- Electricity consumption: between -10 % and -30 %.
- Operating cost for the large system: EUR 1 million per year.

Driving force for implementation

There are low-impact alternatives available and promoted by Regulation (EU) No 517/2014. For some gases, e.g. HFOs (hydrofluoroolefins), there is no ban in Regulation (EU) No 517/2014 but only a reporting obligation. In addition, this Regulation's rules related to equipment aim to minimise leakage, not to prevent the use of all such gases. Moreover, the quota system refers to total tonnes of CO₂ equivalent and does not mention specific gases [158, EC 2014].

Example plants

This technique is implemented in multiple slaughterhouses.

Reference literature

[121, Giner-Santonja et al. 2019], [157, COM 2011], [158, EC 2014], [159, EC 2009], [163, EEA 2020], [206, TWG 2022].

3 SLAUGHTERHOUSES

3.1 General information for slaughterhouses

3.1.1 Production of meat and livestock population in the European Union

The EU-27 produced 48 million tonnes of meat in 2019, comprised of pig meat (52.4 %), poultry meat (30.5 %), bovine meat (beef and veal) (15.9 %), and sheep and goat meat (1.6 %) [204, TWG 2021].

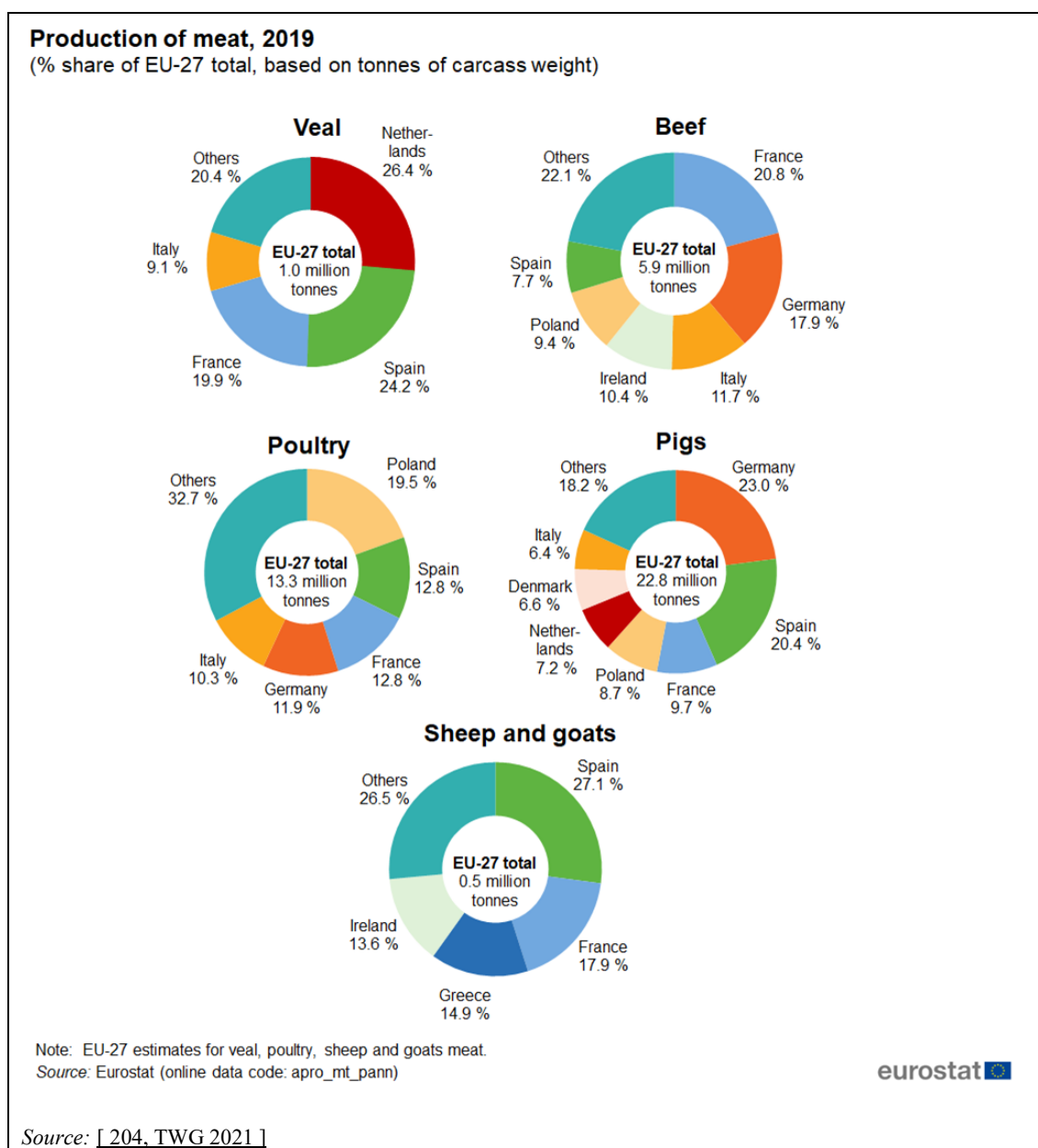

Figure 3.1: Production of meat in 2019 in the EU-27

The EU-27 has a substantial livestock population: there were 143 million pigs, 77 million bovine animals and 74 million sheep and goats in 2019. The majority of livestock are kept in just a few Member States [204, TWG 2021].

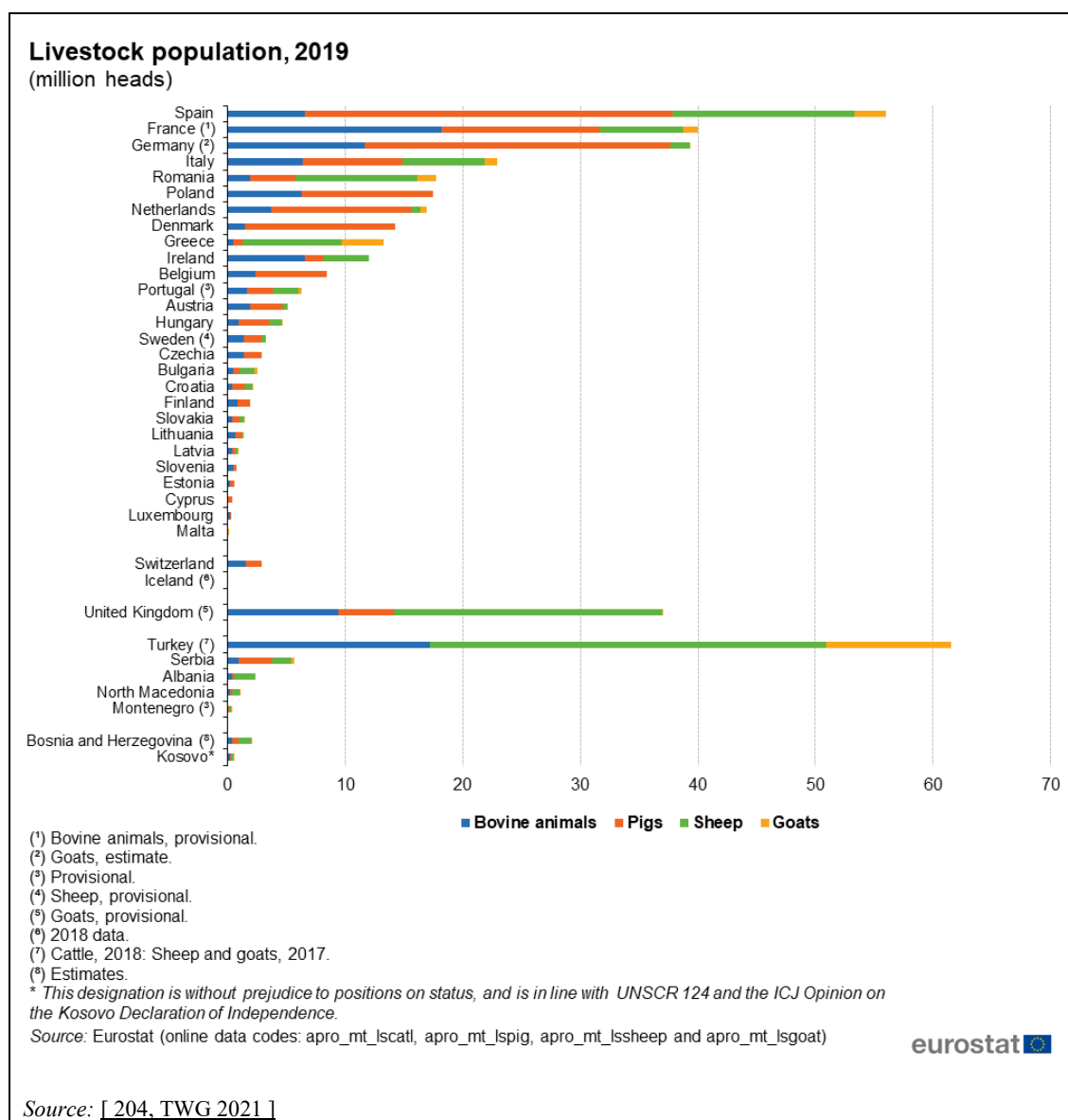

Figure 3.2: Livestock population in 2019 in the EU-27

3.1.2 Trends of the slaughtering industry in the European Union

The slaughtering industry throughout the EU is diverse with many different national characteristics. There does, however, appear to be a trend towards fewer slaughterhouses with increasing average throughputs. All MSs have to comply with common hygiene and structural standards [17, COM 1964], [33, COM 1991] and it is widely believed that this is the reason for the increased consolidation of slaughtering into fewer and larger installations [9, DoE 1993], [22, MLC 1999].

Over 800 slaughterhouses are currently under the scope of the IED in the EU (a figure of 846 slaughterhouses has been reported for all EU Member States except Croatia) [211, TWG 2023].

3.1.3 Level of process automation

During recent years there have been technological developments in meat processing but also in opening, evisceration and other slaughterhouse processes. Moreover, labour costs throughout Europe have led to varying degrees of implementation of the new equipment and varying degrees

of automation of the slaughtering processes. Due to veterinarian and food safety requirements, the automated equipment must be sterilised by hot water between each unit operation. In turn, the degree of automation affects slaughterhouses' consumption of water and energy. Other important parameters for the degree of consumption of water and energy are the utilisation and handling of co-products and the number of work shifts before cleaning [202, Danish Technological Institute 2019].

In Denmark, slaughterhouses are generally divided into three categories, based on their level of process automation [118, Denmark 2015]. This categorisation is described in Table 3.1.

Table 3.1: Categorisation of slaughterhouses according to their process automation level

Type of slaughterhouse	Process automation level
Manual (traditional) type of slaughter - Small capacity	Manual slaughter with few or relatively simple tools. In Denmark, this is used only at the smallest slaughterhouses with an output well below 50 tonnes/day.
Mechanised slaughtering - Medium and high capacity	Slaughter with mechanical feeds and mechanised processes, particularly in connection with rind treatment of pigs. Mechanised slaughtering is typically used at medium-sized and large slaughterhouses, for example Danish cattle slaughterhouses and smaller Danish pig slaughterhouses.
Automated slaughtering - High capacity	Slaughter with mechanical feeds and both mechanised and automated processes (robots). Mechanised and automated slaughtering are typically used in countries with high wages/costs and it is only profitable to use it in the largest slaughterhouses, for example Danish poultry slaughterhouses and Danish pig slaughterhouses.
<i>Source:</i> [118, Denmark 2015]	

Pig slaughterhouses in Germany present fully automated systems for bunging (removal of the anus), opening the complete carcass including breastbone, removing the toenails and splitting the carcass using fully automated saws or cleavers.

Due to their large hourly throughput, most poultry slaughter facilities in Germany use automated stunning and slaughtering systems [181, VDI 2020].

3.1.4 Antimicrobial resistance

Antimicrobials are medicines, mostly antibiotics, used to treat infections or disease in humans and animals. Antibiotics are active substances which impede the growth of and/or kill bacteria. With increasing antimicrobial use, antimicrobial resistance (AMR) has emerged. AMR is internationally recognised as a major societal challenge. It has been identified as a strategic risk facing the EU. It is one of the most serious problems facing modern healthcare delivery. If prudent use of existing antimicrobials and evidence-based infection prevention and control measures were universally implemented and assured, and if effective novel antimicrobials can be developed and swiftly brought to market, an AMR crisis might be averted [123, Ireland 2019].

Antibiotic-resistant bacteria (ARB) are considered to be bacteria which do not react especially sensitively to one antibiotic or several antibiotics, i.e. they are resistant to the impact of these substances. This means that their growth is no longer impeded by the antibiotic. Therefore, infections with such bacteria are more difficult to treat with the currently available antibiotics. The resistance of bacteria to antibiotics can be a naturally existing property or it can be a gained

property. Bacteria can develop a resistance through mutation and through the transfer of genes from resistant bacteria. Documenting ARB in the environment occurs through the cultivation and characterisation of the bacteria [124, Germany 2018].

Antibiotic resistance genes are the area of genetic material (DNA) in which the capacity for antibiotic resistance is located. Documenting resistance genes in the environment occurs through molecular biological methods. When documenting resistance genes based on samples from the environment, it is not generally possible to determine whether they are resistance genes from environmental bacteria, pathogens or free DNA [124, Germany 2018].

Many of the antimicrobials used in the treatment of animals are the same drugs as those used in human medicine. A key area of concern is increasing AMR in a family of bacteria normally resident in the gut of humans and animals (*Enterobacteriaceae*). *Enterobacteriaceae* can be associated with some common and potentially serious infections such as cystitis and bloodstream infection. AMR in *Enterobacteriaceae* is severely limiting treatment options. No novel antimicrobial class effective against this family of bacteria has been brought to market in decades, although some enhancements of older antimicrobials have recently become available and may be valuable in some settings [123, Ireland 2019].

AMR is a growing worldwide concern – which incurs costs both financially and in mortality. It has been estimated that 671 689 infections with AMR bacteria in 2015 in the EU accounted for more than 30 000 deaths and 170 disability-adjusted life-years per 100 000 people (almost on a par with the combined estimate of influenza, tuberculosis and HIV). It is noteworthy that resistance of nearly all antimicrobials has been observed. AMR was named one of the three most important health threats of the 21st century by the World Health Organization in 2014 [165, Thornval 2019].

Of considerable clinical and publicly relevant importance in this respect are those ARB that have gained resistance, such as methicillin-resistant staphylococcus aureus (MRSA), extended spectrum β -lactamases (ESBL *E. coli*) or multi-resistant Gram-negative bacteria (MRGN). These develop especially in places where antibiotics are used because there they have a survival advantage. Hotspots for the occurrence of ARB therefore include hospitals and agricultural livestock keeping. From these hotspots, ARB are able to enter the environment via waste water or through the spreading of sewage sludge, slurry or fermentation residues [124, Germany 2018].

Further accumulation and spread of ARB can occur in the environment. With waste water, sewage sludge, slurry or fermentation residues from biogas plants, not only are ARB released into the environment, but so are antibiotic substances, which exert a selection pressure on bacteria and are therefore able to foster the development of ARB. In this respect, even limited concentrations of antibiotic residues are sufficient to provide resistant bacteria in the environment with a selection advantage compared to non-resistant bacteria. Additionally, the horizontal transfer of genes between bacteria species in waste water can be fostered by the high nutrient content and the high bacterial density in biofilms (a layer of mucus consisting of microorganisms which can also contain ARB and genes). In this respect, pathogens which were previously not resistant can also acquire resistance genes from bacteria [124, Germany 2018].

The technology used at municipal waste water treatment plants is not generally configured for eliminating micro-pollutants and therefore antibiotics. The processes for the reduction of antibiotic substances (e.g. low concentrations of ozone and activated carbon) are unable to effectively minimise bacteria (including ARB) in the waste water. If sewage sludge from waste water treatment plants is applied to soil, active substances can find their way onto fields and meadows [124, Germany 2018].

A considerable number of antibiotic substances have been found in slurry. In particular, the groups of tetracyclines, sulphonamides and trimethoprim are found in very high concentrations,

sometimes of more than 100 mg/kg, especially in pig and poultry slurry, and, in individual cases, in cattle slurry as well [124, Germany 2018].

Slurry and fermentation residues also tend to be contaminated with ARB through excretions from animals that have been treated with antibiotics. It is therefore concerning that slurry and fermentation residues are not just contaminated with antibiotic mixtures, but also other pollutants such as zinc, copper and antimicrobial biocides which also support the formation of new combinations of these resistances in environmental bacteria [124, Germany 2018].

Guidelines for these measurements and analyses require urgent development so as to obtain harmonised results. The parameter COD serves the purpose of documentation of the degradation efficiency and/or elimination performance of biological waste water treatment plants; with cumulative parameters, the AMR is not properly monitored [124, Germany 2018].

Recent studies conducted in Germany [204, TWG 2021] show evidence of AMR in a number of pig and poultry slaughterhouses. AMR bacteria were found in numerous samples in several areas of the slaughterhouses, at different times. Furthermore, AMR bacteria were found in the majority of samples taken from effluents of on-site waste water treatment plants.

3.1.4.1 Methods for identifying AMR

According to the European Union Strategic Approach to Pharmaceuticals in the Environment (COM(2019) 128 final), the European Commission should ensure that the emission of pharmaceuticals to water is considered a possible KEI. This Strategic Approach is a component of the European One Health Action Plan against Antimicrobial Resistance (AMR) (COM/2017/0339 final), where there is a Commission commitment to support the development of technologies that enable efficient and rapid degradation of antimicrobials in waste water and the environment and reduce the spread of AMR. The European One Health Action Plan against AMR highlights the need for research into and the development of new tools for monitoring antimicrobials and microorganisms resistant to antimicrobials in the environment.

The traditional way of assaying AMR in bacteria is time-consuming and expensive per sample. This antimicrobial susceptibility testing (AST) is culture-based and requires a pure culture of the pathogen it is wished to identify. AST can be performed both phenotypically and genotypically. Phenotypic AST determines at which concentration of antibiotic the in vitro growth of bacteria is inhibited. As this method provides phenotypic resistance data, it can be beneficial in a clinical setting where an isolated strain can often be obtained. Genotypic AST must be validated by phenotypic ways in clinical settings, but by using molecular detection the resistance factors can be determined much faster. Usually, either amplification- or sequence-based methods are used to identify genetic mutations and/or resistance genes [165, Thornval 2019].

Current surveillance of AMR often focuses on a few pathogens only and mainly based on passive reporting of phenotypic laboratory results. Metagenomic techniques, using short-read next-generation sequencing data, benefit from the ability to quantify total AMR abundance, based on thousands of especially transmissible resistance genes in a single sample. Hendriksen et al. proposed metagenomic analysis of waste water as an economically feasible approach for continuous global surveillance and prediction of AMR [166, Hendriksen et al. 2019].

A pilot study was conducted with the aim to find a protocol for DNA extraction of slaughterhouse waste water to use for metagenomic analysis to identify AMR determinants. This study applied the global sewage protocol proposed by [166, Hendriksen et al. 2019] and concluded that protocol to be a positive indication for monitoring AMR in waste water from slaughterhouses, although more research work is needed to validate that protocol [165, Thornval 2019].

3.2 General processes and techniques for slaughterhouses

3.2.1 Applied processes and techniques for slaughterhouses

3.2.1.1 Chilling

Carcasses are chilled to reduce microbiological growth. To reduce the internal temperature to less than 7 °C, they are chilled in batch chillers with air temperatures between 0 °C and 4 °C. Typical chilling times are 24-48 hours for beef sides, 12 hours for lamb and 12-24 hours for pig carcasses. Pig carcasses can be chilled quickly in a chill tunnel for about 70 minutes at -20 °C, followed by temperature equalisation at about 5 °C for 16 hours. Alternatively, they may be batch chilled at -5 °C to -10 °C.

The carcasses may then be held in a chilled meat store to further condition the meat prior to despatch to cutting plants, wholesalers, or on to further processing. For cattle, the storage time varies depending on the degree of maturation required by the customer and may be up to 30 days [204, TWG 2021].

The choice of cooling method has an impact on the hygienic quality. Product hygiene has an influence on how long the meat products can remain fresh and thus the distance the products can be exported (nationally, regionally or globally) [118, Denmark 2015].

Air-chilling is generally used where the carcasses are for sale fresh. Chilling can be carried out by batch in a chill room or by a continuous air blast method. Tests have shown that air-chilling can reduce the food contamination rate by up to a third of that after immersion chilling. Immersion/spin chillers can be big users of process water for chilling.

The need for carcasses to be showered prior to entering a chilling tunnel should be examined as not all slaughterhouses do it. Generally, following scalding, pig carcasses do not require further cleaning, although they are cooled with water after singeing.

If the carcasses need to be washed before chilling, it can be done with nozzles, rinsing the required areas only, i.e. the belly at the first skin incision, parts of the front legs and the neck. The water supply can be controlled to ensure that water flows only when the carcasses are in the correct position in relation to the nozzles, or it can be controlled by handheld trigger-operated nozzles.

The washing of carcasses should not take place before they have been through the routine official veterinary inspection, because visible contamination may be washed away and make microbiological contamination difficult or impossible to detect.

Spin chillers have a higher water consumption than spray chillers. The cooling method is typically selected based on the products that one wants to produce; spray cooling is mostly used for fresh products, while spin chillers are used for frozen products [118, Denmark 2015].

3.2.1.2 Casings and offal treatment

The use of casings varies from country to country. Parts of cattle and sheep intestines are SRM [19, COM 2000] and these currently cannot be used for sausage casings. Pigs produce about 19 metres of intestine, which can be used for sausage casings. In Denmark, a large proportion of the intestines are used for edible products. In Norway, intestines are rendered.

If the intestines are destined for food use, after veterinary approval, the pancreas gland is cut off the intestine set. The intestine set is then conveyed to the casing cleaning area. It is then separated into the following parts: stomach, fat end (rectum), small intestine (duodenum, jejunum), large intestine (colon) and 'blind' intestine (caecum). These are then cleaned and may be salted at the slaughterhouse or off site.

If the intestines are to be rendered, the contents may be removed first, e.g. by cutting followed by centrifugation [23, Nordic 2001].

The mucose membrane of the small intestine of pigs can be used for the pharmaceutical industry or in biogas production [23, Nordic 2001].

3.2.1.3 Composting

Raw materials

By-products from slaughterhouses, e.g. lairage bedding, manure, stomach contents, intestinal contents, blood and feathers; from waste water treatment, e.g. screenings, flotation tailings and sludge; solid residues from biogas production; sludge from blood processing and sludge from WWTPs, can all be used in composting.

It has been reported that, with the exception of manure from delivery vehicles and lairage, no single material from a slaughterhouse fulfils the necessary conditions for optimum composting. Rumen and stomach contents contain vegetable structural materials, but have high water contents. Flotation tailings and fat from grease traps contain no structural substances. Composting is possible, e.g. after mechanical phase separation, or after mixing moisture sorbing and structural components with liquid or pasty sludges [42, Tritt W. P. and Schuchardt F. 1992]. Composting is carried out using the rumen contents and sludge from slaughtering from at least one Italian slaughterhouse [64, Sorlini G. 2002]. Although blood is liquid, when combined with paunch for example, it can be pumped and composted in windrows. Other liquids, such as pig slurry, are also mixed with 'dry' materials such as the sludge from WWTPs, for composting.

Fresh and anaerobically pretreated rumen or pig stomach contents dried to a dry matter content of $\geq 20\%$ can be composted without additives, with a bed depth of 1 m. For greater bed depths, the dry matter should be at least 22%. Anaerobic pretreatment can reduce the reaction time from 6 to 4 weeks. If strongly dehydrating machines, such as screw presses, are used to increase the dry matter to $\geq 35\%$, undehydrated flotation tailings and/or fat from the grease trap can be added. Experiments with dehydrated rumen content and flotation tailings, with dry matter contents of 37.6% and 8.8% respectively, have shown that compost can be prepared in 6-8 weeks. During composting the temperature reaches 70 °C, so decontamination is reportedly guaranteed [42, Tritt W. P. and Schuchardt F. 1992].

Composting the solid residues from biogas production can minimise the requirement for capturing and treating the outlet air to remove odours given off as a result of the open handling of by-products and composting. If the biogas production is accompanied by a mechanical separation, e.g. pressing, then there are reported advantages of mass and volume reduction in the biogas plant. It has been reported that, taking into account the costs for disposal of solid slaughterhouse waste, the economic viability of an anaerobic plant in connection with composting could be easily achieved, even without the marketing of the composted material [42, Tritt W. P. and Schuchardt F. 1992].

Commission Regulations (EC) No 1069/2009 and (EU) No 142/2011 set requirements for the composting of animal by-products from slaughterhouses.

Receipt and storage

Odour problems may arise from the composting feedstock.

Process

The most important composting condition is that the raw materials should be appropriately mixed to provide the nutrients needed for microbial growth and activity, which includes a balanced supply of carbon and nitrogen. There should be sufficient moisture to permit biological activity without hindering aeration; oxygen should be at levels that support aerobic organisms and

temperatures should encourage active microbial activity from thermophilic microorganisms [46, Environment Agency 2001].

Raw materials mixed to provide a C:N ratio of 25:1-30:1 are generally accepted as ideal for active composting, although ratios from 20:1 up to 40:1 can give good composting results. Low C:N ratios of below 20:1 allow the carbon to be fully utilised but without stabilising the nitrogen, which may be lost as NH₃ or N₂O. This can cause odour problems [46, Environment Agency 2001].

Windrows

A windrow is a long pile of composting materials, usually shaped as an elongated triangular prism [35, The Composting Association 2001].

Windrows are constructed on a hard standing and drainage is provided to collect any leachate. Wind and rain protection are also provided to minimise air and water entrainment. Water is added to the windrows as and when required for the composting process. Rows reduce by at least one third of their starting size, mainly due to water losses.

The material being composted is turned sufficiently frequently to ensure the maximum sanitation and degradation of the total material and to keep the process fully aerobic [26, Finnish Environment Institute and Finnish Food and Drink Industries' Federation 2001].

The windrow composting process is summarised in Figure 3.3.

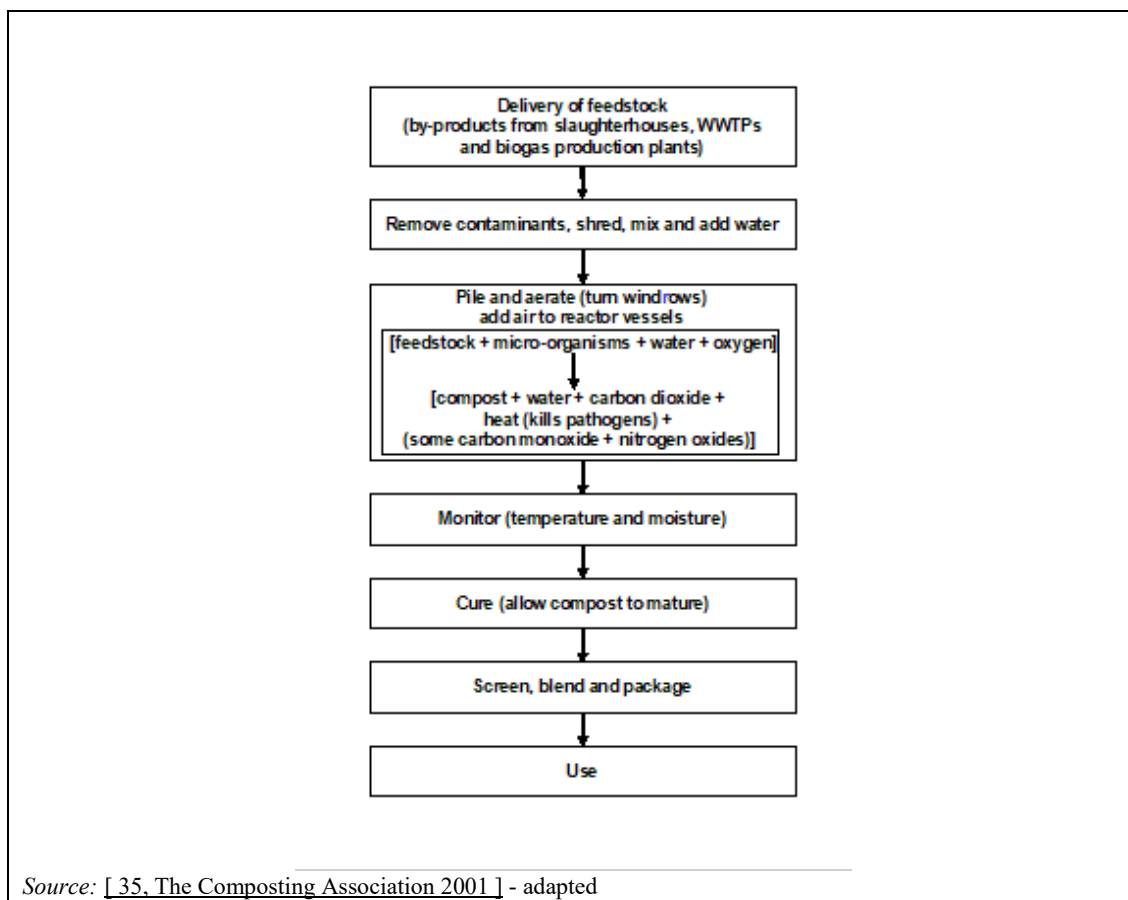

Source: [35, The Composting Association 2001] - adapted

Figure 3.3: Flowchart showing the windrow composting process

In-vessel composting

In-vessel composting refers to a group of composting systems, such as bins or containers, agitated bays, silos, drums or tunnels and enclosed halls [46, Environment Agency 2001]. If composting is undertaken in reactors, the process, including the exchange of respiration gases and temperature, can be controlled better than if windrows are constructed. Consequently, the starting materials can be decontaminated and the malodorous and ammonia-laden air can be captured and treated [42, Tritt W. P. and Schuchardt F. 1992]. The ammonia-laden air is cooled to 38-45 °C, by taking more air in through a damper near the exhaust fan and then sending it to a biofilter, via a water scrubbing tower to remove dust [45, The Composting Association 2000]. For all-year use of open systems, wind and rain protection are required. Regular turning is required during the high-temperature composting period, i.e. when the temperature is > 50 °C [42, Tritt W. P. and Schuchardt F. 1992]. In any case, above 60 °C the microbial activity appears to decrease. The principle of in-vessel systems is to supply air in such excess that it cools the compost, allowing much higher rates of microbial activity.

When supplied in high volumes, air can also help to maintain an open structure in the material. This stops the compost from compacting under its own weight and becoming anaerobic. The material being composted should be 20 % structural material to maintain the airflow through the compost mass.

A reactor vessel composting system is shown in Figure 3.4.

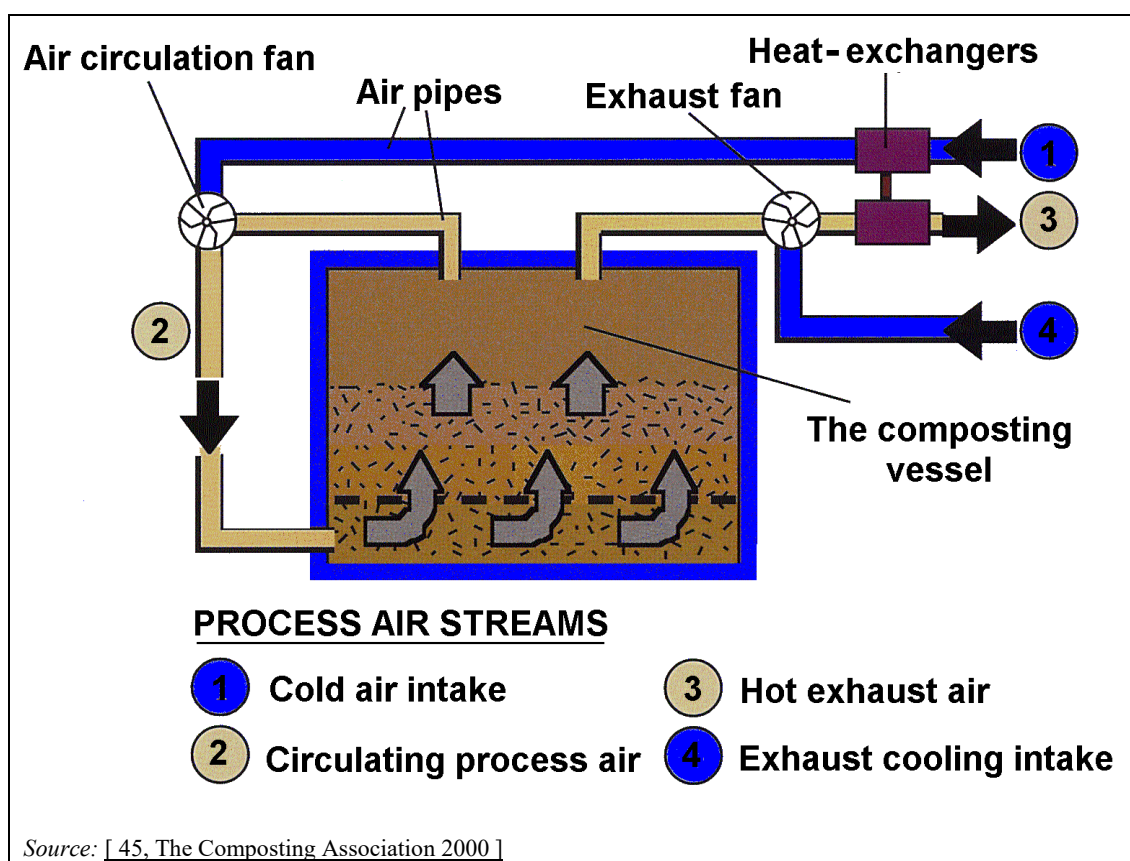

Figure 3.4: Diagram illustrating the in-vessel composting process

Maturation

This happens at mesophilic temperatures, i.e. within a range of 20-45 °C. The moisture evaporation, heat generation and oxygen consumption are all much lower than the active composting stage.

Product

Compost has been defined as ‘biodegradable municipal waste which has been aerobically processed to form a stable, granular material containing valuable organic matter and plant nutrients which, when applied to land, can improve the soil structure, enrich the nutrient content of the soil and enhance its biological activity’ [35, The Composting Association 2001].

3.2.1.4 Storage of slaughterhouse by-products

The animal and public health rules laid down in Regulation (EC) No 1069/2009 (the Animal by-products Regulation) cover, amongst other things, the storage of animal by-products.

Arrangements for the storage of animal by-products vary between premises. To some extent, they depend on the nature and characteristics of the by-product and its intended use or disposal route. Generally, the storage of materials can be undertaken within an enclosed area, operated under negative pressure, provided with extractive ventilation connected to a suitable odour abatement plant. The decision whether to store by-products in such an enclosed and sometimes refrigerated space may depend on whether they are intended for sale or for disposal, at a cost. A major consideration in any case is whether unrefrigerated storage will result in odour problems. Some by-products, such as the manure stripped from fresh intestines, are malodorous when fresh and others become so as they degrade. Malodorous materials can cause problems both during storage at slaughterhouses and during storage, handling, processing and disposal at animal by-products installations.

Some slaughterhouses store animal by-products in open containers in the open air and rely on frequent removal from the site, e.g. once or twice a day, to prevent odour problems from putrescible materials.

Some, but not all, slaughterhouses store blood and other non-process liquids, such as fuel oils, in double skinned tanks; mucosa is stored in regular storage tanks, which can be located outside. Other hazardous substances commonly stored at slaughterhouses include cleaning and sanitising chemicals, effluent treatment chemicals, ethylene glycol, ammonia and other refrigerants. These may be stored in bulk storage tanks, IBCs, or dedicated drum storage areas.

There is a risk of spillage of these substances, especially during handling or transport around the site. Tanks and containers are often located in areas where there is a risk of them being damaged by moving vehicles [4, WS Atkins-EA 2000]. In addition to the environmental risks, there are also health and safety risks associated, not only with the spillage of substances hazardous to health, but also from the vehicle/pedestrian interface. Management of site layout and use, in conjunction with hardware safeguards such as the provision of bunds and crash barriers around storage areas, can reduce the risk of accidents.

3.2.2 Current consumption and emission levels across slaughterhouses

3.2.2.1 Consumption of chemicals in slaughterhouse cleaning

The level of cleanliness achieved depends on a combination of several factors. These include the cleaning agents used, including the detergent reaction time; the water temperature for washing and rinsing and the mechanical treatment applied, e.g. the use of ‘force’ in the water pressure and the use of scouring sponges and brushes. If one of these components is reduced, the others must be increased to achieve the same result.

If the water pressure is increased, the water consumption can be reduced. Enough water is still required, however, to contain the rinsed off dirt in suspension and to transport it to the floor drains. A high water pressure can also influence the working environment, e.g. by causing increased

noise, vibration and aerosol formation, and it can damage electrical installations, machines and building materials. A pressure of approximately 2.53 MPa, i.e. a low-pressure cleaner, used with foam-borne detergents and rinsing water at 50-60 °C, is reported to be most widely used.

Significant resources are consumed during the cleaning but significant savings can be achieved. A slaughterhouse, where no special attention had previously been paid to the use of resources for cleaning, achieved the results shown in Table 3.2 without reducing the standard of cleanliness. Thorough instructions were given to cleaning staff on methods of environmentally correct cleaning, taking account of the use of detergents and water. This was combined with working time studies. As a result, the time used for preparation, pre-cleaning and removal of waste increased, but the total cleaning time was reduced.

Table 3.2: Reduced consumption of water and detergents achieved without loss of cleanliness

	Before	After
Water consumption	9.3 m ³	6.4 m ³
Detergent consumption	9.2 kg	3.0 kg
<i>Source: [23, Nordic 2001]</i>		

Alkaline detergents dissolve and break down proteins, fat, carbohydrates and other types of organic deposit. They can be corrosive, so an inhibitor is sometimes added. These detergents often contain sodium or potassium hydroxide. Their pH varies from approximately 8 to 13, depending on their composition and their degree of dilution for use.

Acid detergents are used to dissolve lime deposits. Nitric, hydrochloric, acetic and citric acids are commonly used. The pH is low and it varies according to the composition of the detergent. They are corrosive. They have some disinfectant properties.

Detergents contain a number of active ingredients, each with a specific function.

Disinfectants are used after cleaning to kill residual microorganisms. The disinfectants commonly used include various chlorine compounds, e.g. sodium hypochlorite and chlorine dioxide. Hydrogen peroxide, peracetic acid, formaldehyde and quaternary ammonia compounds (QACs) are also used, all in aqueous solution. Ethanol is also used. Sodium hypochlorite is the most commonly used compound. With the exception of ethanol, disinfectants must be rinsed off after use.

The choice of detergent used has an effect on the waste water treatment. Some WWTPs have a system for removing phosphates. Others can handle EDTA, phosphonates or similar compounds. The quantity of calcium binder used will vary depending on how soft or hard the water is. Detergent residues may remain in the sludge from the waste water treatment. This may limit the options for disposal of the sludge. This needs to be considered when choosing the detergents.

A study at a Danish pig slaughterhouse showed the consumption of detergents given in Table 3.3. The quantity of detergents used at a slaughterhouse can be based on the surface area of the equipment and installation to be cleaned.

Table 3.3: Quantities of detergent used in Danish pig slaughterhouses

Detergent type	Use per slaughtered pig (g)	Use per tonne of pig carcass (g)
Acid detergents	11 (3-15)	143 (39-195)
Alkaline detergents	41 (18-48)	533 (234-623)
Neutral detergents	3 (estimate)	39 (estimate)
Disinfectants	15 (7-17)	195 (91-221)
Liquid paraffin	4 (1-5)	52 (13-64)
Total		962
<i>Source: [23, Nordic 2001]</i>		

Sprays and rinses typically account for a high proportion of water consumption at slaughterhouses. Sprays and rinses typically consume about 24 % of the water used at poultry slaughterhouses and 30 % of that used at large animal slaughterhouses. Trigger-operated spray nozzles, which control and direct the water, are commonly used to both reduce the water consumption and to provide adequate washing efficiency. Spray technologies have improved in recent years. The latest designs are less susceptible to blockage than those previously available. New designs are also available with improved water efficiency whilst maintaining or often improving the washing effect [4, WS Atkins-EA 2000], [13, WS Atkins-EA 2000].

Cleaning is carried out after production with the use of hot water and detergents and, subsequently, disinfection takes place which often uses a strong oxidation agent, e.g. hypochlorite. The consumption of detergents and hypochlorite in Danish slaughterhouses is summarised in Table 3.4.

Table 3.4: Quantities of detergents and hypochlorite used in Danish slaughterhouses

Type of animal	Average consumption (g/slaughter) (minimum-maximum)	
	Detergents	Hypochlorite
Pig ⁽¹⁾	67.1 (31.7-123.9)	2.0 (0.4-6.8)
Cows ⁽²⁾	108.9 (59.8-201.9)	10.9 (3.7-35.8)
NB: Consumption data related to 3 financial years. ⁽¹⁾ Data collected from 9 pig slaughterhouses. ⁽²⁾ Data collected from 4 cattle slaughterhouses. <i>Source: [118, Denmark 2015]</i>		

3.2.2.2 Emissions to water

Emissions to water from slaughterhouses can be divided into process emissions and emissions from spills and diffuse sources. The main emissions include organic material, which contributes to the BOD and COD levels and inorganic material such as ammonia and phosphorus. Sources of process emissions include the washing of vehicles, washing of carcasses, cleaning of the production area and associated downstream activities such as stomach, tripe and casings washing [1, EPA 1996]. Those operations which emit manure and partly digested feed are increasingly believed to be significant sources of phosphorus emissions [77, Pontoppidan O. 2002].

According to the INERIS report on hazardous substances in industrial waste water, the average emission level at the point of discharge of waste water of 195 slaughterhouses in France is 0.348 mg/l for zinc and 0.058 mg/l for copper [176, INERIS 2016].

In the following figures, emissions from points of release from the data collection are presented. It should be noted that some emission points could be related to non-process water streams (e.g. sanitary water, run-off water).

Figure 3.5 shows reported data (from installations participating in the data collection, for the years 2016 to 2018) for Cu emissions to water from slaughterhouses for direct discharges, as well as applied abatement techniques. The same information for indirect discharges is presented in Figure 3.6.

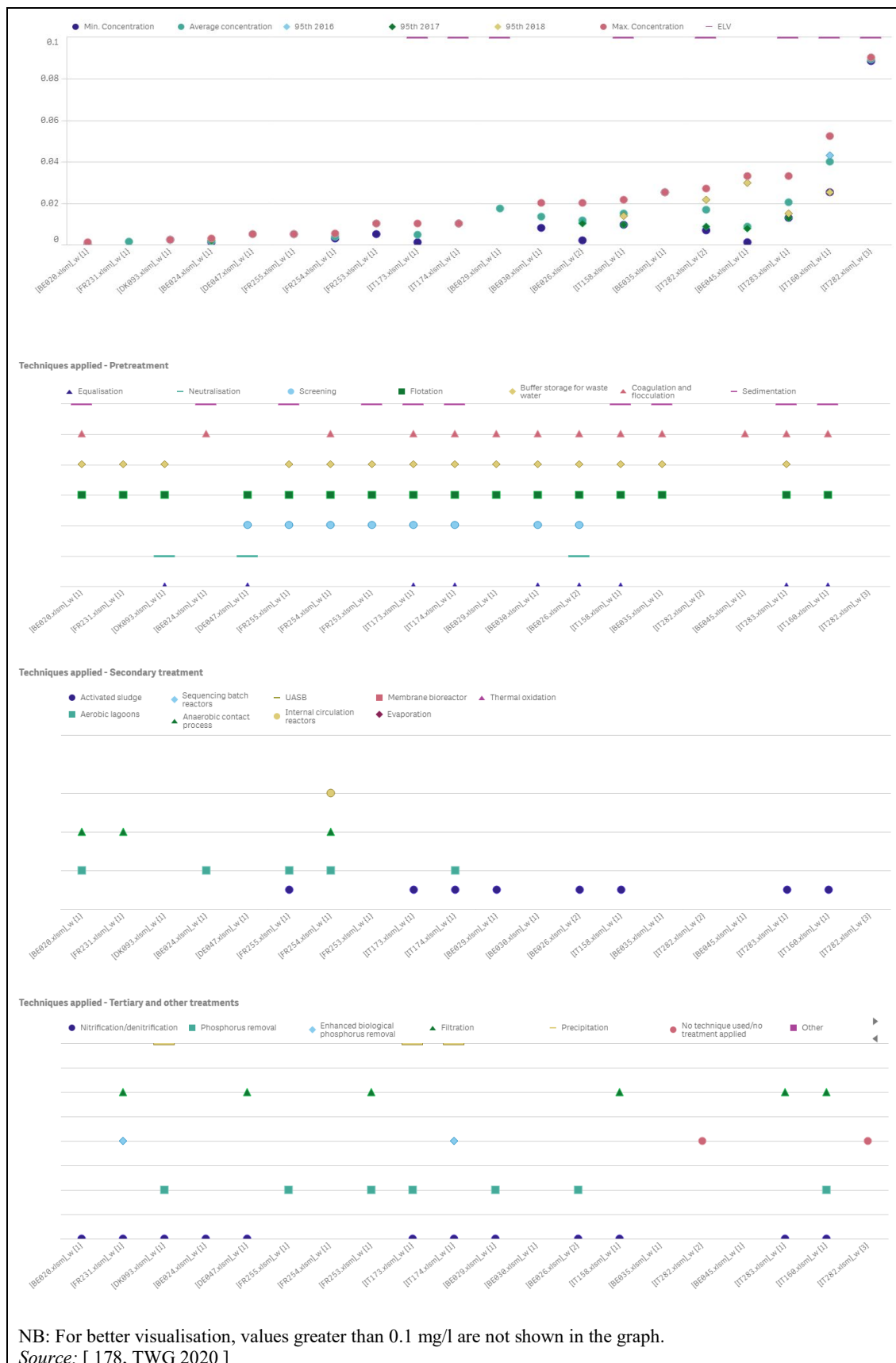

Figure 3.5: Cu emissions to water (mg/l) from slaughterhouses (direct discharges)



Figure 3.6: Cu emissions to water (mg/l) from slaughterhouses (indirect discharges)

Figure 3.7 shows Zn emissions to water (from installations participating in the data collection, for the years 2016 to 2018) from slaughterhouses for direct discharges, as well as applied abatement techniques. The same information for indirect discharges is presented in Figure 3.8.

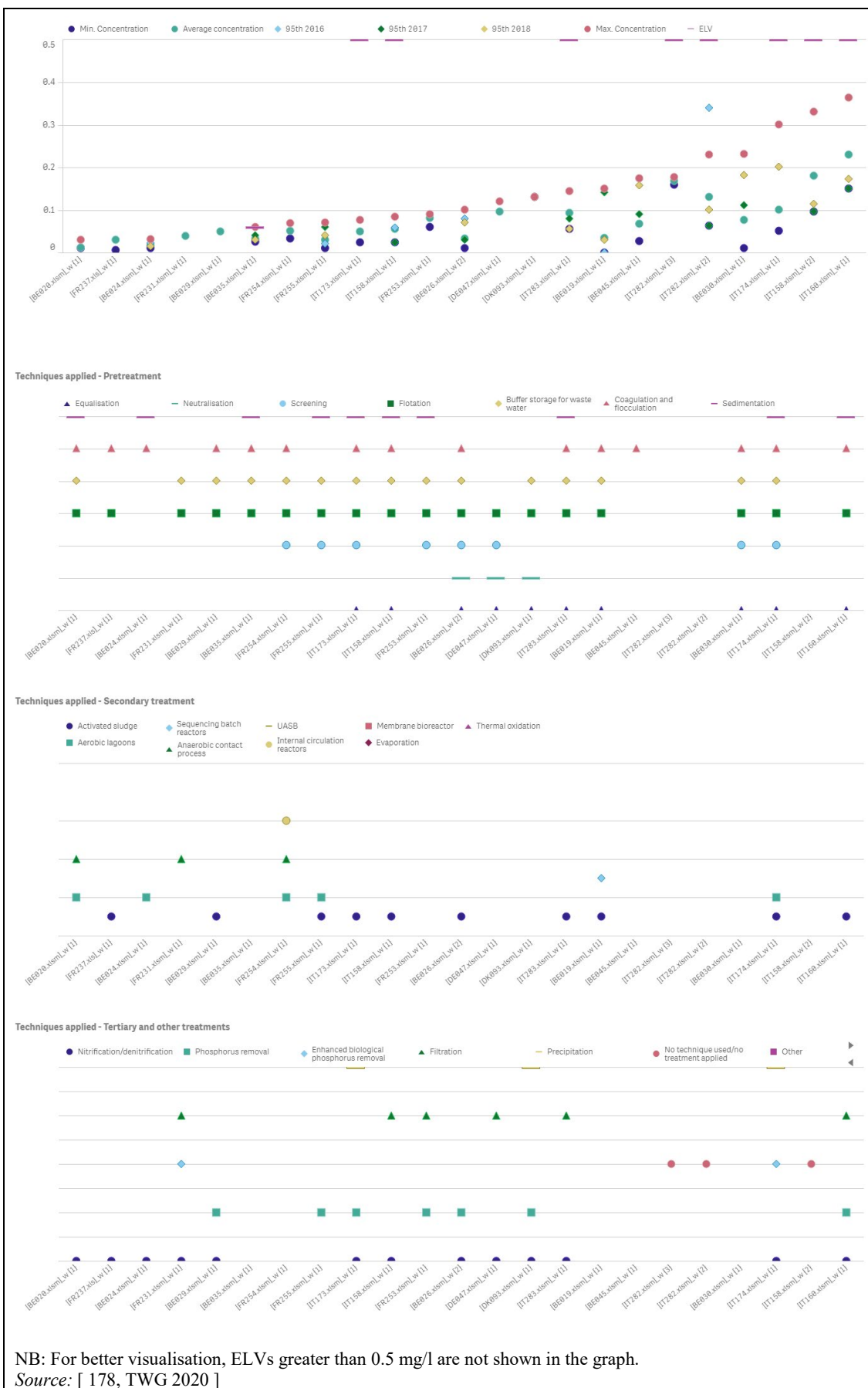

Figure 3.7: Zn emissions to water (mg/l) from slaughterhouses (direct discharges)



Figure 3.8: Zn emissions to water (mg/l) from slaughterhouses (indirect discharges)

Animal feed is a reported source of Cu/Zn emissions to water. Zinc-based trolleys or structures are a reported source of Zn emissions to water [178, TWG 2020]. Uncertainty on the potential sources of Cu and Zn has also been reported [211, TWG 2023].

In Table 3.5 some specific reported sources of Cu/Zn emissions in waste water are presented.

Table 3.5: Reported sources of Cu/Zn emissions in waste water

Installation	Type of installation	Cu and Zn source mentioned in permit
BE019	Slaughterhouse (pigs)	Presence of Cu and Zn is linked to the animal feed.
<i>Source:</i> [207, TWG 2023]		

3.2.2.3 Emissions to air

Odour

For many slaughterhouses odour is the most significant air pollution issue in terms of day-to-day local prevention and control, particularly in built-up areas and in warm weather/climates. The odours are generally associated with the collection and storage of blood, gut contents, inedible offal, heads, feet, bones, meat scraps and SRM waste. Other potential sources are the use of macerator equipment to chop and wash inedible offal, inadequate effluent treatment plant maintenance and any blockage of drainage by meat and fat scraps.

Urine and manure odour from the slaughterhouse lairage areas can also cause a minor nuisance in built-up areas, although the hygiene and welfare standards required at slaughterhouses can mitigate against significant odour from this source.

The collection and storage of slaughterhouse by-products, such as blood, gut contents, inedible offal, heads, feet, bones meat scraps and SRM waste cause some of the most significant day-to-day pollution problems, because of the odours they generate. Some by-products, such as gut contents, inherently have offensive odours. Others, such as blood, become offensive very rapidly. Freshly cut fat takes longer to degrade and cause odour problems. The existence and extent of odour emissions depend on what preventive and control measures are implemented, as well as the local weather and climate. Odour problems increase with exposure, time and temperature of storage. Odour emissions can be minimised and prevented.

To an extent, the emissions during storage depend on the process upstream of the storage, i.e. the whole collection and handling procedure. If for example blood is collected directly into closed and sealed containers then emissions will be prevented whilst the container is closed; however, the blood will ferment within a few hours after being collected and become malodorous. There is always an air valve in the storage container, to exhaust any gas which may be produced, so the escape of odours is possible. If blood cannot be processed immediately, refrigeration is the only reported way to prevent odour production [74, Casanellas J. 2002], although charcoal filters can reduce odour emissions.

If the storage time of by-products which do not have an offensive smell when fresh is kept below the time in which they become offensive, the problem of odour emissions should be avoided. If the time from slaughter to animal by-product use or disposal is kept below the time for odours to be produced, then this will prevent problems both at the slaughterhouse and at the animal by-products installation. Fresher ingredients also produce higher quality products, e.g. from fat melting, and fewer malodorous emissions, e.g. from rendering. For example, the fat collected after stomach washing, which is wet and has a high protein level, is subject to rapid decay and the production of organic acids, which make processing difficult and lead to high production costs [42, Tritt W. P. and Schuchardt F. 1992]. The processing of malodorous materials can also lead to odour problems at the WWTP.

Chapter 3

If by-products, which smell worse as they degrade, are refrigerated then odour emissions are reduced, but energy needs to be consumed to achieve this.

Figure 3.9 and Figure 3.10 show reported data (from installations participating in the data collection, for the years 2016 to 2018) for channelled emissions of odour, as well as the applied abatement techniques, from slaughterhouses. For the majority of emission points, no abatement technique is applied.

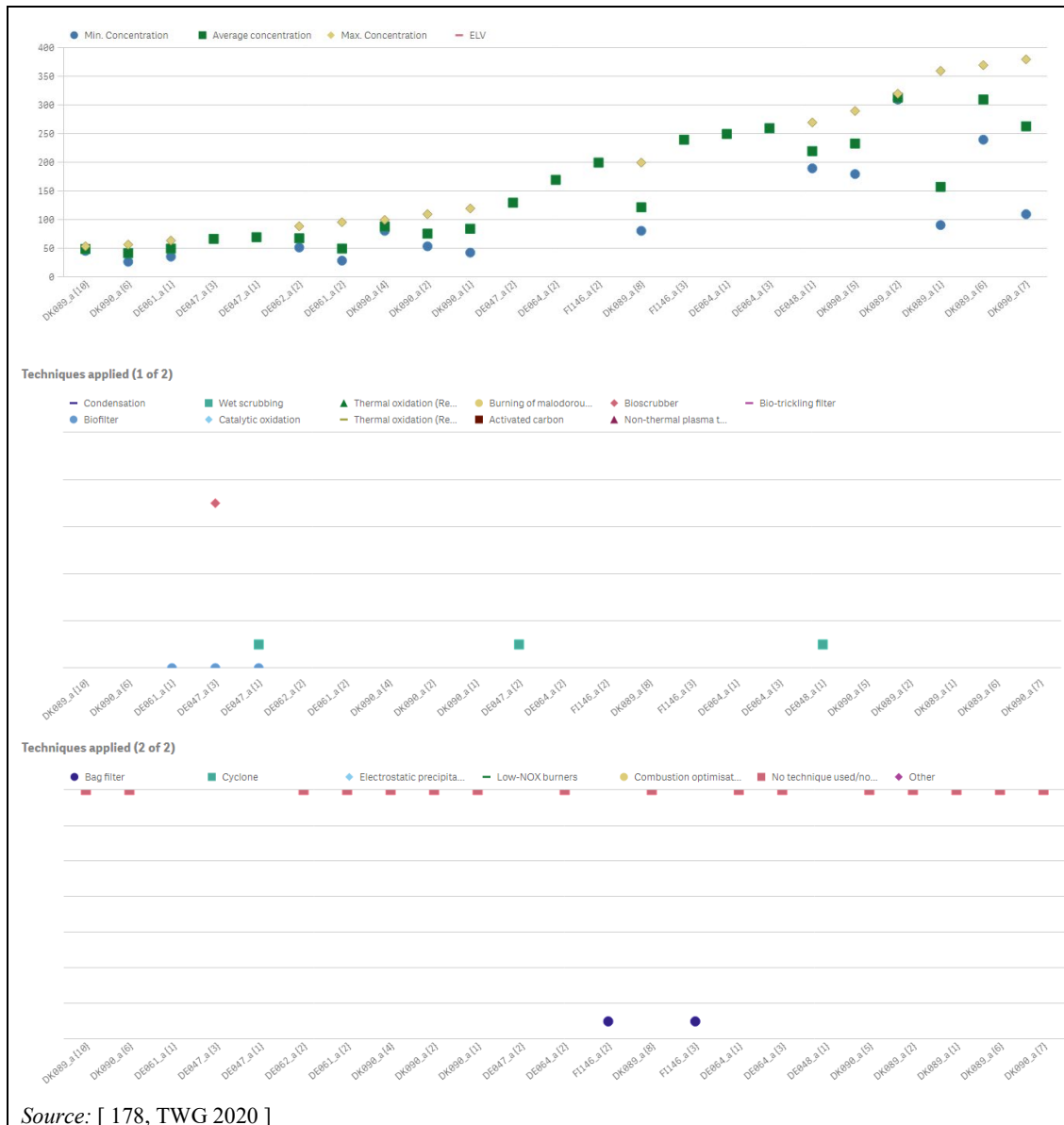

Source: [178, TWG 2020]

Figure 3.9: Odour emissions (ouE/m³) and abatement techniques from slaughterhouses (Part 1 of 2)



Figure 3.10: Odour emissions (ouE/m^3) and abatement techniques from slaughterhouses (Part 2 of 2)

3.2.2.4 Refrigerant losses

According to the data reported, R717 (NH_3) is the most commonly used refrigerant, in about 52 % of the installations participating in the data collection.

Figure 3.11 shows the reported R717 (NH_3) losses (%) (from installations participating in the data collection, for the years 2016 to 2018). The percentage of refrigerant losses refers to the total amount of refrigerants contained in the cooling systems. Data are not necessarily to be interpreted on a year-to-year basis.

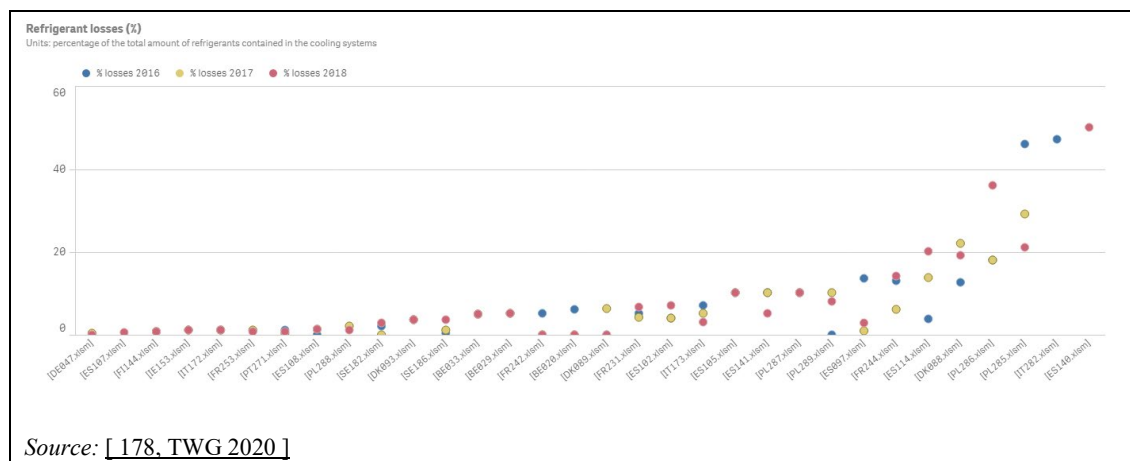

Figure 3.11: R717 (NH₃) losses (%)

The second most widely used refrigerant in the data reported (in about 23 % of the cases) was R404A. Figure 3.12 shows the reported R404A losses (%) (from installations participating in the data collection, for the years 2016 to 2018). Data are not necessarily to be interpreted on a year-to-year basis.

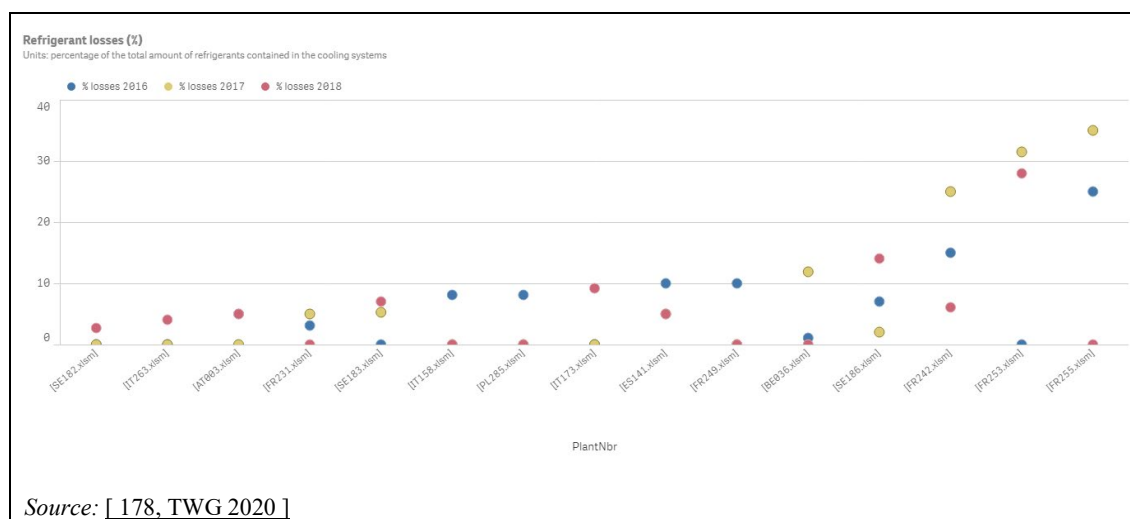

Figure 3.12: R404A losses (%)

Refrigerant losses can be reported as rolling averages. A 3-year rolling average is calculated taking into account the value of a given year and the 2 preceding years. An example is the following: the 2016, 2017 and 2018 R717 (NH₃) losses for installation SE186 are 0.3 %, 1 % and 3.6 %, respectively.

Based on these values, the 3-year rolling average is calculated as: $(0.3+1+3.6)/3 = 1.63 \%$.

When the 2019 value is available, the updated 3-year rolling average takes into account the values of 2017, 2018 and 2019. Assuming that for the year 2019 the R717 (NH₃) losses are 0.5 %, the 3-year rolling average is calculated as $(1+3.6+0.5) = 1.7 \%$.

3.2.2.5 Noise and vibration

Typical noise levels found during working hours and measured at the perimeter fence of a slaughterhouse or at the nearest buildings are 55-65 dB(A). Typical levels of 40-50 dB(A) and

35-45 dB(A) have been reported for the evening and night, respectively. These figures depend on the local conditions such as distance, shielding, reflection, operating time and the local attitude towards minimising unnecessary noise [23, Nordic 2001].

The main sources of noise and vibration are animal noises during unloading and marshalling to the slaughter-line; vehicle movements; compressors; air conditioners; ventilation fans; and carcass splitting. Some of these sources are present 24 hours a day, whereas others coincide with intermittent activities such as animal deliveries or employee shift changeovers.

3.2.3 Techniques to consider in the determination of BAT across slaughterhouses

3.2.3.1 Techniques to increase energy efficiency

3.2.3.1.1 Techniques related to cooling/freezing

3.2.3.1.1.1 Refrigeration management plan

Description

A refrigeration management plan is part of the environmental management system (see Section 2.3.1.1) and entails:

- monitoring of the energy consumption of the refrigeration system;
- operational measures such as inspection and maintenance of equipment, closing of doors when possible;
- equipment operation by experienced staff;
- monitoring of refrigerant losses.

Technical description

It is reported that most refrigeration plants can be improved to save up to 20 % of their energy consumption. Surveying the plant can lead to the identification of technical and operational opportunities to improve energy efficiency and save money.

A plant can be reliable and still be inefficient. A plant designed and operated to be efficient, however, is inevitably more reliable; for instance, the compressor does not have to work so hard in an efficient plant, which makes it less prone to breakdown and therefore more reliable.

Increased energy efficiency can reportedly be improved by a combination of surveying the plant, adopting good housekeeping measures, and carrying out appropriate monitoring, maintenance and control.

Achieved environmental benefits

Reduced energy use. Reduced emissions of refrigerants, typically from small leaks and major accidents.

Environmental performance and operational data

Surveying the plant

Each component of the plant can be investigated separately, to measure/estimate its energy consumption and the associated operating costs. It may also be helpful to identify what exactly is being cooled.

The operating costs can be measured/estimated for each item of the plant by either measuring the current to all meters and power consumers or, for less accurate results, measuring the running times and combining these with the power rating information provided by the manufacturer. Other costs such as maintenance, refrigerant top-up, routine labour and water treatment can be included. This enables both energy and cost savings to be targeted and monitored.

Two types of cooling load can be identified: (1) product loads, i.e. the targets of the cooling and (2) parasitic loads, i.e. those not directly related to the product, e.g. heat generated by lights or motors in cooled spaces. This distinction is useful because the actions which can be taken to minimise the two types of load are different.

Good housekeeping

Good housekeeping by trained and aware personnel can lead to significant cost savings. Some examples of good housekeeping practice around the refrigeration plant and in cooled rooms include the following:

Around the refrigeration plant

If condensers are not kept clean the condensing temperature increases. A 1 °C increase in condensing temperature can increase running costs by 2-4 %. The cooling capacity also drops and the required temperature may not be achieved. The warmer the air entering the condenser, the higher the condensing temperature will be. The condensers can be shaded if necessary and warm air can be prevented from being recirculated. Anything obstructing the airflow can be removed.

Bubbles in the refrigerant sight glass when the system operation is stable usually signify that the system is leaking. This is not only illegal and harmful to the environment, but it also increases the cost of running the system and the refrigerant then has to be replaced. Also, the system may not be able to provide the cooling required. Leaks thus need to be found and repaired before the system is recharged with refrigerant.

The oil level in the compressor sight glass(es) can be checked regularly, as the compressor will be more likely to fail if the oil level is too low or too high. Neither refrigerant nor oil are used up during normal plant operation; refrigerant can only be lost because of a leak, whereas oil levels may vary because of a leak or if oil is trapped somewhere in the system.

Running the plant hotter than necessary can reduce reliability and performance. The plant room can be ventilated, e.g. using an extractor fan that is switched on when the temperature gets too high.

Ensuring that the control settings for the plant are optimised, labelled and easy to find can encourage personnel to maintain efficient operating conditions.

In cooled rooms

Ice around a door indicates poor sealing, which also incurs a consequent increase in the heat load. This may mean that the system capacity cannot sustain the increased load and the store temperature may increase. Such problems may be repaired by ensuring that product is not left in the doorway and by repairing the sealing on the door. If a door has to be used regularly, strip curtains may be fitted and maintained.

Impeding the airflow over the cold store, by obstructing the evaporator airflow, leads to a temperature increase throughout the store and consequently to the system consuming more power than necessary or possibly not reaching the required temperature.

A defrost-on-demand system, which initiates a defrost when needed rather than by a timer, has reportedly reduced power consumption by 30 % in some applications. Evaporators that operate below 0 °C should be completely defrosted before ice starts to cover the fins. This may be every few hours or every few days. When the evaporator is iced-up the evaporating temperature drops. A 1 °C drop in evaporating temperature can increase the running costs by 2-4 %. The capacity also drops and the store may not get down to the required temperature. If the defrost elements are not working properly, then the frost build-up on the evaporator will worsen.

Other heat sources in the cold store, e.g. lights, forklift trucks, other motors and charging devices, cost money due to the electricity they consume and again through running the refrigeration system to remove the heat they produce. Personnel also give off heat.

Ice formation on the floor and walls of a cold store indicate that a lot of air is entering the room, bringing with it moisture, which is condensing on the evaporator and the structure. It can also indicate a defrost problem.

Cold stores are often held at lower temperatures than necessary because of worries about failure. Having a cold store at a lower temperature than necessary makes failure more likely. A temperature 1 °C lower than necessary can reportedly add 2-4 % to the plant running cost.

In other areas

Refrigeration systems have to remove heat from many sources other than just the product or space intended to be cooled. These sources of heat can be minimised. Some common examples of heat sources are pumps and fans that circulate cold air, chilled water or an anti-freeze solution. These deliver most of the power they consume as heat into the cooling load, so they need to be switched off when not required.

Cold refrigerant pipes between the evaporator and compressor, particularly the larger suction line pipes, pick up heat from their surroundings. These can be insulated and not run through hot areas.

Monitoring

Monitoring enables trends and developing faults to be detected before they become a major and expensive problem, e.g. monitoring of refrigerant leaks.

Monitoring for very small plants

Even for small and simple plants, installing gauges to log suction and discharge pressures, daily or, at the very least, weekly can result in significant savings with very limited costs. Any change, such as a fall in suction pressure, indicates a problem, such as a refrigerant leak. If the discharge pressure rises and the ambient temperature does not then this may indicate a blocked condenser.

Maintaining a data log helps detect problems early and it helps the contractor to diagnose problems.

Monitoring for most plants

For most plants, more detailed monitoring may prove worthwhile. In some cases, a computerised monitoring system may be justifiable.

Maintenance schedules

Maintenance work will depend on the size and complexity of the plant, as well as on the components used. It has been reported that, as a minimum, the following should be checked:

- | | |
|-----------------------|--|
| Compressors | - oil level |
| | - suction and discharge pressures and temperatures |
| Condensers | - fans and pumps are working |
| | - fan guards are safe and secure |
| | - condenser is not blocked; clean condenser if necessary |
| Gauges | - for accuracy |
| Receiver | - if there is a liquid level sight glass or gauge, that it contains the right amount of refrigerant |
| Evaporator | - as for condensers, plus the degree of frost build-up |
| | - liquid-line sight glass to see that it contains the right amount of refrigerant |
| Safety and efficiency | - all safety controls |
| | - control switches to ensure that they have not drifted from the optimum set-point |
| | - suction superheat to confirm that expansion valves are operating correctly |
| | - pressure vessels, e.g. liquid receivers, may legally need a written scheme of inspection to be carried out by a competent person |
| Others | - no untoward vibration on any part of the system |
| | - pipework insulation is still in good condition |

- for leaks, e.g. of ozone depleting substances
- insulation for damage, if you have a cold store or cabinet
- cold store safety door releases.

At one example refrigeration plant, high condensing pressures were experienced, leading to increased energy usage and higher fuel bills. The condenser was cleaned, which solved the problem, and a plan to replace the condenser was thus abandoned.

Control

It has been reported that keeping controls simple and getting settings right can be a big step towards making a refrigeration plant operate as efficiently as possible by, for example, setting the thermostat to achieve the best energy efficiency for the plant without compromising reliability. Marking the normal readings on gauges helps the early detection of equipment malfunction. There are a number of low-cost controls that can be added to a plant, which give reportedly good results. Automatic controls can be used to switch off the refrigeration plant and/or lights when they are not required. Automatic switches or variable speed drives can be fitted to fans and pumps that circulate cold air, chilled water and anti-freeze solutions. Paybacks of 1 year or less have been reported. For plants with multiple condensers or cooling towers, these allow the minimum condensing temperature possible for the plant to be obtained and this allows cost savings in cooler weather.

Cross-media effects

None.

Technical considerations relevant to applicability

Applicable in all slaughterhouses.

Economics

It has been reported that an investment made to save up to 20 % of energy normally has a payback time of well under 2 years.

Driving force for implementation

Reduced energy costs.

Example plants

This technique has been reported in approximately 25 % of the slaughterhouses participating in the SA data collection [178, TWG 2020].

Reference literature

[31, Greek Ministry for the Environment 2001], [85, ETSU 2000], [90, ETSU 1999], [178, TWG 2020].

3.2.3.1.1.2 Installation of groundwater cooling of refrigerant

Description

Groundwater is used to cool refrigerant gases.

Technical description

Groundwater can be used to cool refrigerant gases to reduce the amount of energy used.

Achieved environmental benefits

Reduced energy consumption.

Environmental performance and operational data

The refrigeration system can account for 40-70 % of the electricity consumption of a slaughterhouse. Groundwater cooling has been introduced to cool the refrigerant and to reduce

the condenser operating pressure from 1.22 kPa to the 0.81 kPa, which is reported to be optimal from an energy-saving point of view.

Cross-media effects

The technique can cause a rise in groundwater temperature. A system in Denmark has been closed down because of the resultant rising temperatures in neighbouring wells.

Technical considerations relevant to applicability

Applicable in situations where there are sufficient groundwater supplies to not cause a significant risk of raised groundwater temperatures.

Driving force for implementation

Reduced energy use.

Example plants

This is standard practice in poultry slaughterhouses [156, TWG 2019]. It is also used in at least one pig slaughterhouse in Denmark.

Reference literature

[23, Nordic 2001], [73, Italy 2002], [156, TWG 2019].

3.2.3.2 Techniques to reduce water consumption

3.2.3.2.1 General techniques

3.2.3.2.1.1 Avoidance and minimisation of carcass rinsing, combined with use of clean slaughter techniques

Description

Skilled and careful slaughter is performed minimising the need to wash the carcass after inspection by a veterinarian.

Technical description

Skilled and careful slaughter, dressing and evisceration prevents or minimises carcass contamination and thus improves product quality, whilst also minimising the need to wash the carcass after inspection by a veterinarian. Rinsing can be limited to the splitting cut, to remove bone dust from cattle, the chest cavity and the foreshanks.

Achieved environmental benefits

Reduced water consumption and contamination of water.

Environmental performance and operational data

With a manually controlled showerhead, a cattle carcass may be rinsed with 8-10 litres of water (approximately 30-40 l/t).

In pig slaughterhouses, water consumption levels at the slaughter and bleeding unit operations have been quoted as 10-50 l/t and 30-40 l/t, respectively, with the water being supplied constantly, regardless of carcass throughput.

Cross-media effects

None.

Technical considerations relevant to applicability

Carcass rinsing may not be applicable due to hygiene requirements.

If carcass washing is required, due to visual contamination, e.g. by hair or feathers, washing may be required. The use of water sprays mixed with compressed air can minimise the amount of water used.

Sheep can be 'safely' left unwashed, providing dressing practices are of a high standard, and the meat quality is generally better, i.e. nicer appearance, colour and quality. Wet carcasses tend to go 'sticky' when chilled. Likewise, if de-hairing of pigs and evisceration of poultry is done skilfully, washing can be avoided.

Manual washing may be preferable to automatic rinsing in cabinets, where the water consumption is often unnecessarily high. If the temperature of the water is kept to a minimum, i.e. cold water is used, fat uptake can be avoided. The use of water sprays mixed with compressed air can also lessen the amount of water used.

Economics

A spray gun may cost EUR 200 (cost in 2001).

Driving force for implementation

Reduced water costs and improved product quality.

Example plants

Various slaughterhouses.

Reference literature

[23, Nordic 2001], [37, Pontoppidan O. 2001], [52, Brindle J. 2001], [103, BPF 2003].

3.2.3.2.1.2 Application of automated water start/stop controls throughout the slaughter-line

See also Section 2.3.5.1.3.

Description

Sensors such as photocells are fitted to detect carcasses and parts of carcasses and to supply water as required.

Technical description

Sensors such as photocells can be fitted to detect carcasses and parts of carcasses and to supply water as required. Water supplies can be turned off automatically between carcasses and during all breaks.

Achieved environmental benefits

Reduced water consumption, reduced volumes of water requiring treatment and, if the pressure is regulated, reduced entrainment of biological matter and contamination. It has been predicted that the savings could be up to half of the total water use during production, together with the water saved during cleaning periods, by ceasing the practice of allowing it to continue to run.

Environmental performance and operational data

Care taken during the selection, installation and maintenance of the photocells can make certain that they are reliable and their correct position ensures that carcasses are washed to the extent planned, even if they are swinging on the overhead rail or vary in size.

Use of the technique presupposes that each carcass needs to be cleaned and the technique does not distinguish between clean and dirty carcasses or dirty parts of carcasses.

If the slaughter-line is not working to its maximum capacity, the water savings are greater if water is only supplied when there is a carcass present. This has been measured at slaughter and bleeding unit operations.

In pig slaughterhouses, water consumption levels at the slaughter and bleeding unit operations have been quoted as 10-50 l/t and 30-40 l/t, respectively, where water has been supplied constantly, regardless of carcass throughput.

Cross-media effects

Energy to pump water could be saved if the need for carcass washing was removed. Water may be wasted if clean carcasses are washed.

Applicability

Equally applicable to new and existing slaughterhouses.

Economics

The cost of an automated water stop/start control has been reported to be USD 255 (cost in 2001). For a pig slaughterhouse, the estimated annual saving in water use was 6 060 m³.

Driving force for implementation

Reduced water costs.

Example plants

A pig slaughterhouse in the US.

Reference literature

[23, Nordic 2001], [49, AVEC 2001], [108, Clitravi - DMRI 2003]
[72, Ockerman H.W. and Hansen C.L. 2000].

3.2.3.2.1.3 Continuous dry and segregated collection of by-products along the length of the slaughter-line

See also Sections 3.2.3.4.1.1 and 3.2.3.3.1.

Description

Drip trays/troughs are positioned to collect liquids and solids.

Technical description

Depending on the position on the slaughter-line, drip trays/troughs can be positioned to collect liquids and solids. Drip trays/troughs can be provided for the collection of, for example, dripping blood between the bleed hall and the scalding tank, on pig slaughter-lines; at head and hide removal stations and for blood and mixtures of solids for rendering or other by-products, which are destined for further processing. The troughs can be linked by drains, pumps or suction devices to the relevant collection vessel. The position and design of the tray/trough and the means of preventing mixing with water and the transportation of the liquids or solids depend on the unit operation, the degree of segregation of different materials desired/required and their ultimate intended use, or disposal route. Examples of materials which can be collected and transported dry include offal not intended for human consumption and feathers. For materials destined for human consumption, temperature control is particularly important and some slaughterhouses transport offal in water due to the cooling effect. This can be avoided by transferring the materials to chillers quickly after they are removed from the animal.

The amount of waste is particularly large for chest opening, pluck set removal and carcass-splitting operations. It is, therefore, very important to install collection systems in these areas. The removal could be done with special suction installations or pumps. In one case study slaughterhouse, all of this waste was formerly washed into the sewerage system during interval cleaning. It was found to be possible to do all the initial cleaning dry, e.g. using shovels, squeegees or vacuum suction, thereby avoiding water usage during the working period. The initial cleaning at the end of the working period can also be done without using water.

Elsewhere, when rumen is removed it is immediately transferred by dedicated pneumatic tunnel to the 'dirty zone', where it is pressed by a hopper system and unloaded into a container for composting.

Achieved environmental benefits

Reduced water consumption and less entrainment of by-products in water. If by-products are collected efficiently, the volume of water required for cleaning is reduced and consequently less energy is used to heat the cleaning water. Less detergent is also required. The amount of waste water produced and its BOD, COD, nutrient and detergent levels and CO₂ emissions are all reduced.

The segregation of liquids and solids destined for use or destruction has several advantages. If sufficient separate collection systems are provided, it reduces cross-contamination between different by-products. Segregation of the by-products can, therefore, reduce potential odour problems from materials which, even when fresh, emit the most offensive odours, i.e. by storing/removing them separately under controlled conditions, instead of having to control a greater volume of mixed by-products. It also reduces the use of water to transport the by-products and to clean the installation (the by-products are largely confined to the drip tray/trough). In addition, cleaning may be easier.

Also, by minimising cross-contamination, segregation enables individual by-products which can be used to be used, instead of being disposed of because they are mixed with materials which cannot be used. All materials can, therefore, be used or disposed of in the most appropriate way for them.

Environmental performance and operational data

At a Danish slaughterhouse, the amount of organic material collected per pig increased by 0.2 kg (2.6 kg/t pig carcass) after a trough was installed in the 'clean slaughter-line', i.e. where evisceration, splitting, weighing, cleaning and classification took place and wet suction was introduced. In addition, the pollution of the waste water was reduced by 0.52-0.65 kg BOD per tonne of pig carcass. Similar results would be expected using a squeegee/shovel, provided that correct procedures were consistently followed.

In another case study, the COD loading in the waste water was reduced. In a Norwegian slaughterhouse, the combination of fitting a double drain system in the bleed area and collection trays for blood under the scraping table and the evisceration area, together with a pump to the blood tank, reduced the total COD discharge by 22 %, i.e. by or more than 1.25 kg COD per tonne of pig carcass.

Some slaughterhouses use a long trough with a screw conveyor under the slaughter-line to eliminate the need for wet floor cleaning during working hours. The material can be swept or squeegeed to the screw conveyor, the mechanism of which should be inaccessible to the operator, for safety reasons.

The use of drip trays to prevent material from falling on the floor has health and safety advantages, since it can significantly reduce the risk of slipping accidents. It may also influence the downstream value and use of the by-product, if hygiene is an important consideration, e.g. if it is to be used in blood processing.

Cross-media effects

Some energy will still be required, e.g. to operate pumps, but that energy which would have been used to heat additional cleaning water can be saved.

Technical considerations relevant to applicability

Applicable at all slaughterhouses.

Economics

Each trough costs approximately EUR 300 per metre (cost in 2001). If a pumping system is installed, the additional cost will be approximately EUR 3 000-4 000.

The payback period was calculated to be 8 months for a Danish slaughterhouse paying a surcharge on waste water and approximately 4 years when no surcharges are paid.

The payback time for the Norwegian example quoted above was a little over 6 years. Waste water treatment costs are saved.

Driving force for implementation

Reduced waste water treatment and waste disposal and the associated reduced costs.

Example plants

At least one Danish and one Norwegian slaughterhouse.

The direct collection of rumen contents for composting is undertaken in at least two cattle slaughterhouses in Italy.

Reference literature

[23, Nordic 2001], [31, Greek Ministry for the Environment 2001], [37, Pontoppidan O. 2001], [62, Germany 2002], [64, Sorlini G. 2002].

3.2.3.2.1.4 Insulated and covered knife sterilisers

Description

Knife steriliser boxes, located along the length of the slaughter-line, are insulated and fitted with fixed covers.

Technical description

Knife steriliser boxes which are located throughout the length of the slaughter-line can be insulated and fitted with fixed covers, which have slots through which two knives can be placed with their blades immersed in water at 82 °C. The cover can be designed and made to suit the type of knife used at each workstation.

Achieved environmental benefits

Reduced water consumption and consequently reduced energy consumption.

Environmental performance and operational data

The water consumption measured in one uninsulated knife steriliser, with constantly running water, has been reported as approximately 2 000 l/d. By insulating and covering the steriliser, the heat loss can be reduced, so the frequency and volume of top-up water required is consequently also reduced.

Use of a 20 mm thickness of insulating material is reported to reduce the heat loss by 80 %, compared to an uninsulated steriliser, without a lid.

Cross-media effects

None reported.

Technical considerations relevant to applicability

Applicable at all workstations in all slaughterhouses.

Economics

Each steriliser costs approximately EUR 700-800 (cost in 2001). In Denmark, the payback time for fitting new insulated steriliser boxes has been estimated to be 1 year.

Driving force for implementation

Reduced water consumption and consequently reduced energy use.

Example plants

This technique is in use in at least two Danish slaughterhouses, one of which is slaughtering cattle and the other pigs.

Reference literature

[23, Nordic 2001], [77, Pontoppidan O. 2002].

3.2.3.2.1.5 Knife sterilisation using low-pressure steam

Description

Water is heated by an injection of steam in a low-pressure steam steriliser, which is then used to sterilise knives.

Technical description

In a low-pressure steam steriliser, the water is heated by an injection of steam. The water is changed manually, or controlled by a timer, as required. The water consumption is approximately 500 l/d or less depending on how often the water is changed.

Achieved environmental benefits

Reduced energy use and reduced water consumption.

Environmental performance and operational data

Measurements in 1992 on knife sterilisers at Norwegian slaughterhouses showed an energy consumption of 500 kWh per day equal to 0.3 kWh per head (17 kWh/t of carcass). When the method of knife sterilisation was changed from hot water to steam, the energy consumption was reduced by 75 %, to 4.24 kWh/t of carcass.

The sterilisation is carried out at 150 kPa and after the sterilisation unit the steam pressure is reduced to 50 kPa.

The heat of condensation is used to maximum effect, which reduces the amount of water needed to maintain the sterilisation units at 82 °C.

It is reported that there is no significant risk to the operator from the steam and that the risk from the alternative, i.e. hot water, is greater because it is kept at 400-600 kPa.

Cross-media effects

None reported.

Technical considerations relevant to applicability

Applicable in all slaughterhouses.

Economics

No information provided.

Driving force for implementation

Reduced energy use and water consumption.

Example plants

The technique is applied in the installation FR242 [178, TWG 2020].

The technique has been applied in Norwegian sheep/lamb slaughterhouses for many years.

Reference literature

[23, Nordic 2001], [77, Pontoppidan O. 2002], [178, TWG 2020].

3.2.3.2.1.6 Periodic change of water in electrically heated knife sterilisers, controlled by a timer

See also Section 2.3.5.1.3.

Description

Disinfection and cleaning of the cutting tools is done with the application of sterilisers with heating elements and with electric heating of water.

Technical description

A number of large cutting tools are used on the clean slaughter-line. For hygiene reasons, they are cleaned and disinfected several times during the working day, at the end of the day's work and before being used when they have been soiled. In small slaughterhouses, it may be possible to abandon the hot (82 °C) water system if new sterilisers with heating elements are installed and if electric heating of water is installed for major equipment. This significantly reduces heat losses from the hot water system and gives better temperature control. Water consumption can be reduced by periodically changing the water in the sterilisers, using a timer control.

Achieved environmental benefits

Reduced water consumption. Less water at 82 °C is used and consequently less energy is used to heat the water.

Environmental performance and operational data

The consumption of water at 82 °C at the clean slaughter-line of a Danish slaughterhouse has been measured to be 24 litres per pig (312 l/t of carcass). The energy consumption for heating this volume of water is in the order of 2 kWh per pig (26 kWh/t of carcass). The consumption in one uninsulated knife steriliser with constantly running water in a Danish slaughterhouse has been measured to be approximately 2 000 l/d.

A periodic change of the water in the steriliser with timer control has been reported to reduce the water consumption to approximately 500 l/d.

Cross-media effects

None reported.

Technical considerations relevant to applicability

Applicable in all slaughterhouses.

Economics

The payback period has been reported to be between 6 months and 2 years.

Driving force for implementation

Reduction of water and energy costs.

Example plants

At least one Danish slaughterhouse.

Reference literature

[23, Nordic 2001], [33, COM 1991], [37, Pontoppidan O. 2001].

3.2.3.2.2 Techniques relating to casings and offal treatment

3.2.3.2.2.1 Dry emptying of cattle/pig stomachs

Description

Cattle/pig stomachs are emptied by using machines without water.

Technical description

The stomachs can be cut open in a machine. The contents fall into the base of the machine, from where they are pumped away for use in biogas production or composting for example. Machines are available which can empty the stomachs without using water, apart from the amount used to clean the knife for cutting the stomachs.

For the further processing into the final product, water is needed for washing and cleaning the stomachs, and for a constantly hygienic environment. Subsequently, the stomachs are centrifuged with a minimal amount of water to make sure all feed has been removed.

Water is also used to clean the knife for cutting the stomachs.

Achieved environmental benefits

Reduced water consumption and consequently a reduced volume and BOD loading of waste water.

The stomachs can be used as human food, e.g. ox tripe, or for pet food.

Environmental performance and operational data

Modifying old machines from double rinse to single rinse halves the water consumption.

Cross-media effects

None.

Technical considerations relevant to applicability

Generally applicable.

Economics

The cost, including for a new stomach machine, was reported as being approximately EUR 28 000 (cost in 2001). The cost of modification of an old stomach machine was reported as being approximately EUR 16 000 (cost in 2001).

For a Danish slaughterhouse, the capital cost for a new pig stomach-emptying machine was reported to have been repaid in approximately 5 years. Old stomach-emptying machines with a double rinse can, however, be altered to single rinse machines, at low cost.

Driving force for implementation

Reduced water consumption and treatment costs.

Example plants

Slaughterhouses in Denmark [118, Denmark 2015].

Reference literature

[23, Nordic 2001], [37, Pontoppidan O. 2001], [36, COM 2000], [118, Denmark 2015], [207, TWG 2023].

3.2.3.2.2.2 Regulation and minimisation of water use for moving intestines

See Section 2.3.5.1.3.

3.2.3.3 Techniques to reduce emissions to water

3.2.3.3.1 Optimisation of bleeding and blood collection

Description

The bleeding operation is optimised to ensure that the maximum quantity of blood is collected and contained at the bleed area.

Technical description

The bleeding operation can be optimised to ensure that the maximum quantity of blood is collected and contained at the bleed area. This reduces the requirement to manage dripping blood along the length of the slaughter-line.

For large animals, the use of hollow knives gives a lower yield of blood collection than the more traditional method of cutting the animal's throat to initiate bleeding, which is then assisted by the animal's heartbeat and by gravity. For pigs, the blood yield has been reported to be 75-80 %. In most cases the time for bleeding using a hollow knife is limited to 20-40 seconds, because of the speed of operation of the slaughter-line and because this is reported to be the time needed to collect the highest quality blood by this method. In practice, the bleeding time with the hollow knife can be extended, to maximise the hygienic collection of blood. The animals can subsequently be hung over a blood collection trough until the amount of blood dripping from the carcass is insignificant. The second 'bleed' contains clots, so it is not food/pharmaceutical-grade blood and it may be sent for rendering, biogas production or composting for example. The use of the hollow knife method for the hygienic collection of blood from cattle has ceased in some countries, e.g. Denmark, because blood from ruminants is not used for human consumption or animal feed, although it is still used in some other countries for human food and pet food.

Where the traditional method of bleeding is used, the time allowed for this may be calculated to optimise the blood collection. It has been reported that for cattle the optimum bleeding time is about 7 minutes and for pigs 5-6 minutes.

It is reported that bleeding carousels can be supplied with bleeding alarms that sound if not enough blood has been drained out of the animal before it leaves the bleeding area. Bleeding carousels for hollow knife bleeding can be operated by one operator for up to 360-380 pigs/h, or 120-130 cattle/h. At higher capacities, two operators are required. It is also reported that during traditional bleeding the knife disinfection required between each animal is often omitted by the operator, but that this is less likely when a bleeding carousel is used.

The hollow knife method is not relevant to poultry. The blood is not collected for food, feed or pharmaceutical use, although it can be fed to fur animals; otherwise, it has to be disposed of. Nevertheless, optimisation of the collection minimises the amount which ends up in the WWTP. It is reported that 90 seconds is normally sufficient time and that the blood is stored in chilled vessels to prevent odour problems.

Discussion can take place between blood plants and slaughterhouses regarding optimising blood collection for subsequent blood processing. Blood processors may stipulate that hollow knives and small drip trays are used to collect blood. Blood for rendering is usually collected in large trays or on the bleed hall floor, from where it drains away to collection tanks. Slaughterhouses sell blood to blood processing companies and renderers charge for its collection. The cost depends on the disposal method. The bleeding area can have drip troughs fitted above floor level, to minimise contamination. The troughs can have drops to facilitate wet suction and/or scraping of blood or coagulated blood lumps to the blood tank prior to cleaning. Some installations carry out both blood processing and rendering on the same site and the transport of blood for both activities may be easily facilitated. With the agreement of the company receiving the blood, the water from the initial washing can be collected in the blood tank.

The extension of blood collection times does not necessarily have to slow down production. A sufficient number of hollow knives can be provided in the carousel to ensure that there is enough time for the bleeding process, without a queue developing before bleeding or waiting time after bleeding. Likewise, for bleeding by the traditional cut to the throat, collection can be extended by a number of means. The bleeding trough can be extended in the bleed hall and a stainless steel collection trough/slide, which drains to the blood tank, can be installed which extends from the blood collection area all the way to the scalding tank or de-hiding area. In short, in bleed halls both the overhead rail, from which the carcasses are suspended, and the bleeding trough can be designed to follow a circuitous route, which allows enough time for bleeding. The 'circuitous route' option reportedly works well for sheep. The trough/slide can be movable, or detachable, as necessary.

Extending the blood collection facilities reduces the importance of training slaughterhouse operators in methods to minimise drip loss along the line, e.g. not to manually shunt pigs towards the scalding tank prematurely.

Achieved environmental benefits

A higher proportion of blood is used in processes downstream of the slaughter and so consequently less ends up in the waste water, for treatment in either the on-site WWTP or the municipal WWTP. Blood contamination of water leads to elevated BOD, COD and nitrogen levels. If blood is allowed to drip along the length of the slaughter-line, it will drain into the WWTP, as well as potentially adding to the cleaning water consumption requirements for the plant and equipment.

In addition, the collection of blood with minimal water uptake increases the yield of usable blood and reduces the energy consumption, for treatments where the blood is dried. Otherwise, energy has to be expended to handle and remove the water.

Environmental performance and operational data

The following blood yields have been quoted following the use of traditional bleeding methods. For cattle, 16 litres of blood can be collected in 1 minute, from a total of 18 l. In this case, the kill speed is relatively low and in 2 minutes practically all the blood could be collected, using a long tray. For pigs, 3.2 litres of blood can be collected in the first 40 seconds immediately after the slaughtering and 3.5 litres in 1 minute, of a total of potentially 3.8 litres.

A small slaughterhouse reportedly implemented several improvements, including increasing the bleeding time for cattle to 7 minutes; it collected and separated the blood for composting instead of dumping it in the local river; controlled inventories; reduced salt consumption and established a training programme. After less than 1 month, the company had reduced its water consumption by 15 %, the pollutant load in the waste water by 34 % and the consumption of salt by 60 %.

Cross-media effects

Blood processing causes less contamination of waste water than blood rendering, but the energy consumption for processing is at least twice as high as that for rendering blood.

Technical considerations relevant to applicability

The collection and separation of blood, instead of discharging it either to a river or to a WWTP, is applicable to all slaughterhouses. Some slaughterhouses discharge blood to their local WWTP or collect it in a tank and then send it by tanker to a WWTP which is designed to treat it.

The provision of an extended stainless steel collection trough/slide is applicable in all slaughterhouses.

Economics

The payback time for the increased bleeding time, for composting the separated blood, controlling the inventories, reducing the salt consumption and establishing a training programme was less than 1 month.

The cost of the trough/slide is reported to be about EUR 300 per metre (cost in 2001).

Driving force for implementation

The driving force for the increased bleeding time was the reduction of water consumption and the high organic load in its waste water.

The driving force for provision of an extended stainless steel collection trough/slide was a reduction in waste water treatment costs.

Example plants

Extended stainless steel collection troughs/slides are used in a small poultry slaughterhouse and a small pig slaughterhouse in Denmark.

Reference literature

[23, Nordic 2001], [37, Pontoppidan O. 2001], [53, APC Europe 2001], [64, Sorlini G. 2002], [67, EAPA 2002], [68, UNEP 2002], [74, Casanellas J. 2002], [81, Brindle J. 2002], [94, Hupkes H. 2002].

3.2.3.3.2 Use of a squeegee for initial cleaning of the blood collection trough

See also Section 2.3.5.2.1.

Description

A squeegee with an offset handle is used to remove blood without using initial washdown water.

Technical description

A squeegee with an offset handle can be used to remove blood from the blood trough into the blood collection vessel without using initial washdown water.

Achieved environmental benefits

Reduced consumption of water for cleaning and reduced COD and BOD levels in the waste water. Increased potential for waste minimisation. Increased potential for recovery or recycling of blood. The water previously used in the initial washdown no longer had to be handled and heated in the blood recovery process.

Environmental performance and operational data

The system was reportedly introduced in an example pig slaughterhouse, to replace the practice of using six sprays along and above the bleed trough to wash some blood from the trough into the blood collection vessel. This reportedly removed 50-60 % of blood in the trough, but resulted in some water going to the blood collection vessel and the remainder of the blood going to the WWTP. The use of the squeegee reportedly enables 80-90 % of the blood on the trough to be recovered. For the example slaughterhouse, this resulted in the recovery of an additional 11.3 kg/d of blood, representing 2.3 kg BOD, which had previously been directed to the WWTP. The additional labour required was considered to be insignificant.

Cross-media effects

None.

Economics

No information provided.

Technical considerations relevant to applicability

Applicable in all slaughterhouses.

Driving force for implementation

Reduction of water consumption, waste water production and waste water contamination.

Example plants

This technique is commonly used at UK slaughterhouses [156, TWG 2019].

Reference literature

[72, Ockerman H.W. and Hansen C.L. 2000], [156, TWG 2019].

3.2.3.3.3 Double drain from the bleed hall

Description

The bleed hall has a system with two drains, one to the collection tank and one to the sewer.

Technical description

The bleed hall can have a system with two drains, one to the collection tank and one to the sewer. The system is designed so that the drain to the collection tank is open during slaughtering and the drain to the sewer is closed. During cleaning the opposite is true. The maximum possible proportion of the blood can be collected without dilution with water. The discharged waste water can contain a minimum quantity of blood. Some systems incorporate an interlock system, which prevents slaughtering from starting if the drain to the sewer or to a blood tanker is open.

Additionally, before hosing the bleed hall area, the blood can be scraped with a squeegee to the collection tank.

Achieved environmental benefits

Reduction of organic matter (BOD) and N in waste water. Collected blood can be used for manufacturing blood meal.

Environmental performance and operational data

No information provided.

Cross-media effects

None.

Technical considerations relevant to applicability

Applicable in all slaughterhouses.

In existing plants, it will be necessary to change the floor gradient in the bleed hall and to install a collection tank for blood. The changes can usually be made within the existing available area.

Economics

The total cost for changing the floor drain was reported as being in the order of EUR 25 000-35 000 (cost in 2001).

Technical considerations relevant to applicability

Applicable in all slaughterhouses.

Driving force for implementation

The reduction of organic matter and nitrogen in waste water, thereby reducing the cost of waste water treatment and discharge.

Example plants

This technique is commonly used.

Reference literature

[23, Nordic 2001], [37, Pontoppidan O. 2001], [36, COM 2000].

3.2.3.3.4 Cessation of feeding of animals 12 hours prior to slaughter

Description

Feeding of the animals is stopped 12 hours prior to slaughter.

Technical description

Stopping feeding the animals 12 hours prior to slaughter reduces the quantity of undigested contents in their stomachs. However, the animals are not necessarily under the control of the slaughterhouse 24 hours before slaughter, so the implementation of such a policy would require cooperation with the farmer and the haulier, taking care not to contravene any animal welfare requirements.

Achieved environmental benefits

Reduced manure, paunch and soiled bedding, which might otherwise increase the BOD of wash-water, from vehicles, the installation, the equipment and the animals and which will subsequently require waste water treatment. The risk of odour arising from the manure, paunch and soiled bedding could be reduced.

Environmental performance and operational data

No information provided.

Cross-media effects

None.

Economics

No information provided.

Technical considerations relevant to applicability

May not be applicable due to animal welfare considerations, particularly in view of the obligation that animals which have not been slaughtered within 12 hours of their arrival shall be fed [156, TWG 2019].

Driving force for implementation

Reduced manure production and consequently reduced waste water contamination. There are hygiene benefits too, due to the decreased risk of faecal contamination of hides and carcasses.

Example plants

This technique is commonly used.

Reference literature

[21, COM 2009], [31, Greek Ministry for the Environment 2001], [156, TWG 2019].

3.2.3.3.5 Minimisation of animals' time in the slaughterhouse to reduce manure production

Description

The time that animals are kept in the slaughterhouse is shortened, whilst respecting animal welfare considerations.

Technical description

Shortening the time that animals are kept in the slaughterhouse, whilst respecting animal welfare considerations, will reduce the amount of urine and faeces produced.

Achieved environmental benefits

Reduced manure, paunch and soiled bedding, which might otherwise increase the BOD of wash-water and require waste water treatment. These materials are, however, the raw materials for

biogas manufacture and composting, so any produced need to be collected as dry as possible and with minimum mixing with other wastes to be useful.

Environmental performance and operational data

The implementation of such a policy would require cooperation with the farmer and the haulier, taking care not to contravene any animal welfare requirements.

Cross-media effects

A reduction of the amount of manure or faeces produced in the lairage will mean that the stomach and intestinal contents of the slaughtered animal will be greater. These will then have to be collected during and after evisceration.

Economics

No information provided.

Technical considerations relevant to applicability

Applicable in slaughterhouses where the delivery of animals can be managed to coincide with slaughter times, therefore minimising the time the animals are kept in the lairage.

Driving force for implementation

Efficient operation of the slaughterhouse.

Example plants

This technique is commonly used.

Reference literature

[31, Greek Ministry for the Environment 2001].

3.2.3.4 Techniques to reduce emissions to air

3.2.3.4.1 Techniques mainly used to reduce organic/odour emissions

3.2.3.4.1.1 Segregated storage and handling of different kinds of animal by-products

Description

Animal by-products are collected, handled and stored separately or in categories, depending on their further use or disposal route and on the potential environmental consequences of mixing them.

Technical description

By-products can be collected, handled and stored separately or in categories (C1, C2 and C3), depending on their further use or disposal route and on the potential environmental consequences of mixing them. If, for example, they are the same material but at different stages of degradation and one causes an odour problem, then mixing them would lead to an increased volume of malodorous material and make the whole volume less usable.

Achieved environmental benefits

Reduced odour emissions associated with the storage of malodorous by-products, both at the slaughterhouse and at animal by-products installations.

The segregation of liquids and solids destined for use or destruction offers several advantages. If sufficient separate storage systems are provided, it reduces cross-contamination between different by-products. The segregation of by-products can reduce potential odour problems from those materials which even when fresh emit the most offensive odours. They can be stored or removed separately under controlled conditions. If by-products which require refrigeration are separated from those that do not, the refrigeration capacity required will be less.

Also, by minimising cross-contamination, segregation enables individual by-products to be used instead of disposed of. Each by-product can potentially be used or disposed of in different ways.

Environmental performance and operational data

No information provided.

Cross-media effects

Increased consumption of water and/or energy [156, TWG 2019].

Technical considerations relevant to applicability

Applicable in all slaughterhouses. Segregated by-products should be demanded by the market; otherwise, they can be processed together by an animal by-product installation [156, TWG 2019].

Economics

No information provided.

Driving force for implementation

Odour control at the slaughterhouse. Reduced waste disposal costs.

Example plants

No information provided.

Reference literature

[26, Finnish Environment Institute and Finnish Food and Drink Industries' Federation 2001], [156, TWG 2019].

3.2.3.4.1.2 Back venting of blood tanks during unloading

See also Section 2.3.8.2.9.

Description

An activated carbon filter is used in the blood tank to treat the exhaust gas, mainly when blood is transferred to trucks.

Technical description

The exhaust air from the truck is back vented into the blood tank which has a carbon filter on the breather vent. The air displaced from the blood tank during filling is also treated by the carbon filter on the tank breather vent.

Achieved environmental benefits

Reduced odour emissions.

Environmental performance and operational data

Odour levels of 8 million odour units inside blood tanks have been reported [60, United Kingdom 2002].

Cross-media effects

None reported.

Technical considerations relevant to applicability

Generally applicable to blood tanks, in particular when sensitive receptors are close to the installation.

Economics

No information provided.

Driving force for implementation

Prevention of odour emissions beyond the site boundary.

Example plants

The Süddeutsche Truthahn AG site in Ampfing (Germany) [185, Karlis et al. 2020].

Reference literature

[185, Karlis et al. 2020].

3.2.3.5 Techniques to minimise the environmental impact of the use of refrigerants

3.2.3.5.1 Refrigeration management plan

See Section 3.2.3.1.1.1.

3.2.3.5.2 Preventive and corrective maintenance

Description

The correct operation of the refrigeration equipment is regularly reviewed and any deviations/malfunctions are corrected/fixed in a timely manner.

Technical description

A well-operated maintenance regime can ensure, for example, the prompt repair of leaks and faults which can lead to refrigerant losses. Examples of maintenance practices include:

- checking the refrigerant sight glass for bubbles; bubbles in the sight glass usually mean a system is leaking;
- finding the leaks and repairing them before the system is recharged with refrigerant;
- checking that the oil in the compressor sight glass(es) is at the right level; the compressor will be more likely to fail if the oil level is too low, or too high;
- inspection of pipes and valves.

If pipework is vibrating it is more likely to fracture, causing a major refrigerant leak. Provision of anti-vibration pipe mountings/arrangements and/or a length of flexible pipework can prevent this.

Achieved environmental benefits

Reduced risk of ozone depletion and global warming.

Environmental performance and operational data

A well-operated maintenance regime can ensure, for example, the prompt repair of leaks and faults which can lead to refrigerant losses. Simple modifications can often result in considerable reductions of refrigerant losses.

Cross-media effects

None reported.

Technical considerations relevant to applicability

None.

Economics

No information provided.

Driving force for implementation

- Reduced consumption of refrigerants.
- Legislation.

Example plants

This technique is implemented in multiple slaughterhouses.

Reference literature

[130, COM 2005], [178, TWG 2020].

3.2.3.5.3 Use of refrigerant leak detectors**Description**

A centralised alarm system is used in order to promptly identify refrigerant leaks.

Technical description

The detection systems/units can detect a wide range of refrigerant gases including R717 (NH₃), fluorinated refrigerants and R744 (CO₂). They include various sensor technologies to match the specific refrigerant and safety requirements of the refrigeration system, e.g. electrochemical, semiconductor, and infrared sensors.

Achieved environmental benefits

Reduced risk of ozone depletion and global warming.

Environmental performance and operational data

It is very important to carefully select the sensor location. The ease of access for maintenance should also be taken into account.

Cross-media effects

None reported.

Technical considerations relevant to applicability

None.

Economics

No information provided.

Driving force for implementation

- Reduced consumption of refrigerants.
- Legislation.

Example plants

This technique is implemented in multiple slaughterhouses.

Reference literature

[178, TWG 2020].

3.3 Slaughter of large animals

3.3.1 Applied processes and techniques

Processing operations at slaughterhouses vary depending on the type of animal being slaughtered. The most significant difference is that for cattle and sheep the hide is removed. Pig skins are usually retained, although the bristles are removed and the surface of the skin is singed. Other differences relate to the difference in animal physiology and size [4, WS Atkins-EA 2000].

The slaughter process, although relatively labour-intensive, is becoming increasingly automated. For instance, machinery is being developed to mechanise carcass dressing and this tends to incorporate automatic carcass washing at every stage.

3.3.1.1 General applied processes and techniques for all large animals

3.3.1.1.1 Animal reception and lairage

The animals are unloaded via ramps which should preferably be at the same level as the truck, have a non-slip surface and be sufficiently long to allow adult animals to be able to put all four hooves on. If unloading bridges are used, a direct connection can be made between the vehicle delivering large animals and the lairage. Looking after the animals' welfare reduces the risk of injury to them and subsequent waste, so it also has environmental advantages [101, COTANCE 2003]. After animals are unloaded the lorries are cleaned, for hygiene reasons. Most slaughterhouses have a dedicated vehicle wash area for this purpose. In some cases, bedding such as straw or sawdust is used. If so, this is removed during vehicle washing after each delivery. The wash-water is discharged for waste water treatment and the manure and dirty bedding are collected.

Ideally animals should arrive at the slaughterhouse clean, although they may get dirty during the journey, e.g. from manure, and washing upon arrival is an option. Washing the live animals can cause problems if there is not enough time for them to dry before they are slaughtered. Wet hides and skins can deteriorate more quickly than dry [101, COTANCE 2003], [99, Czechia 2002]. There are conflicting views about the value of clipping. It has been encouraged to minimise the risk of both carcass contamination and operator exposure to *Escherichia coli* 0157. To reduce the emissions to water and the production of waste, the slaughterhouse could make agreements with the farmer or transporter of the animals regarding supplying fasted animals [204, TWG 2021].

The animals are often held in the lairage to allow them to recover from the stress of the journey. This improves the quality of meat by allowing adrenaline and glycogen levels to recover to normal levels. Pigs do not have sweat glands and are prone to heat stress during warm weather. To prevent this, they are kept cool by fine water sprays applied by shower arrangements in the lairage pens.

Most animals are retained for only a couple of hours before slaughtering, but some may be kept overnight to facilitate an early morning start. In general, farmers prefer their animals to be slaughtered on the day of arrival. Farmers are paid on the carcass weight of each dead animal and many believe that this decreases if the animals are kept overnight.

A variety of lairage floor constructions are used. The most common are solid concrete floors; dimpled concrete floors, to allow animals adequate grip; or slatted concrete floors with underfloor drainage to slurry tanks. For animal welfare reasons, slatted concrete floors are not generally used for sheep because their hooves can become trapped in the slats. Suspended mesh flooring is reported to work well in sheep lairages and, like slatted floors, they allow dirt to drop through and generate heat, which helps to dry the animals before they are slaughtered. Lairages for sheep/lambs are often simple and may have only a simple supported roof without walls.

Bedding is only used to a minor extent, but an official veterinary surgeon will insist that there is enough bedding to prevent the animals from getting dirty while in the lairage and/or there is sufficient dry bedding to dry off any wet animals. It is also generally used for overnight lairage. This is usually straw, but waste paper and sawdust are used at some installations. It has to be dry and of good quality. Lairages are normally cleaned by shovelling the solid manure and straw into a skip and then washing the lairage floor with HPLV hoses. In some countries, lairages are washed down and disinfected each time the lairage is emptied [100, Italy 2003].

Straw and manure from delivery vehicles and lairages may be used as fertiliser, subject to public health legislation. Sheep/lambs may be sheared before slaughter, but this may reduce the value of the skin, because it removes the option of 'doubleface' production, i.e. skins tanned with the wool on, and it reduces the possibilities for recovering wool from the pelt.

Cattle that are dirty may have clumps of manure intertwined with their hair. This material is removed prior to slaughter. This is usually done by dry clipping the hair. At some slaughterhouses the animals are washed with a powerful hose [83, Durkan J. 2002].

3.3.1.1.2 Slaughter

Animals are taken from the lairage along a fenced or walled passageway constructed to allow them to walk in single file or in small groups to where they are stunned and slaughtered.

Cattle are led one at a time into a stunning pen, which prevents the animal from moving and has a tiltable bottom and sides. The animal's head must be positioned in such a way that the stunning equipment can be applied and operated easily, accurately and for the appropriate time. Business operators shall ensure that animals are not placed in restraining equipment, including head restraints, until the person in charge of stunning or bleeding is ready to stun or bleed them as quickly as possible [21, COM 2009]. After stunning the animal collapses to the bottom of the pen, the operator then actuates a handle and the pen side opens allowing the animal to slide out onto a dedicated landing area on the slaughter hall floor.

Cattle are stunned before bleeding, normally using a captive bolt pistol activated by expanding gas either from an air compressor or a blank ammunition cartridge. The pistol is accurately located at a point on the midline of the skull, above the level of the brow ridges of the eye sockets. Bulls and boars, which have massive skulls, are sometimes shot with a rifle bullet. There are also some non-penetrative percussion pistols in use, which can only be used for ruminants of less than 10 kg of live weight. One captive bolt pistol, known as the Hantover stunner, injects air as well, thus scrambling the brain. This can result in central nervous system material entering the blood stream, therefore it is not used in some countries [53, APC Europe 2001].

Pithing during slaughter is prohibited under legislation, to prevent the transmission of TSE [34, COM 2001]. There is some resistance to the prohibition of pithing on slaughter operator safety grounds [18, COM 2001]. Pithing involved the insertion of a long rod into the hole left by the captive bolt and reduced muscle contractions during carcass dressing. Paper and cloths used to clean the captive bolt are classed as SRM. Electrical stunning of cattle is undertaken in the US, Australia and New Zealand [101, COTANCE 2003].

Sheep and pigs are also stunned before bleeding, using a captive bolt pistol or electrical tongs. The traditional stunning method for pigs involves applying scissor-like tongs or head plates with a current of at least 1.3 A, at a minimum voltage of 190 V, for about 5 s. For sheep, the current is normally at least 1 A. For pigs, in recent years the use of CO₂ baths has become more popular. The pig is exposed to two stages of gas, firstly a mixture of 30 % CO₂ to increase respiration and then a mixture of 70-82 % CO₂ (depending on the size of the pigs), to induce anaesthesia. The concentration of CO₂ for stunning pigs must be at least 80 % by volume [21, COM 2009].

The removal of as much blood as possible is important to maximise the quality of the meat. In many cases, animals such as pigs and sheep could be killed by electrocution, rather than being merely electrically stunned. In pigs, cardiac arrest does not affect the rate and extent of bleeding.

After stunning, the animals are hung by one or both of their hind legs on an overhead rail which carries the carcasses through the intermediate processes and into the chiller unit. Small multi-species slaughterhouses may have a common slaughtering and processing line, where the height of the workstation can be adjusted to match the height of the carcass. Large slaughterhouses typically operate separate slaughtering and processing lines for different species.

In at least one Danish slaughterhouse, the cattle are tipped from the stunning pen onto a table, where their neck arteries are then severed. The animal is then shackled and raised using an elevator platform to the hanging position, for bleeding.

During ritual slaughter, the restraint of ruminants before slaughter using a mechanical method intended to avoid any pain, suffering or agitation and any injuries or contusions to the animals is obligatory [21, COM 2009].

The following welfare issues have been reported as crucial during the general slaughter process phase [199, EFSA 2019]:

- During the slaughter processes, animals may experience negative welfare consequences such as heat stress, cold stress, fatigue, prolonged thirst, prolonged hunger, impeded movement, restriction of movements, resting problems, social stress, pain, fear and distress.
- Consciousness is a prerequisite for the animal to experience pain, fear and distress. Therefore, animals that are ineffectively stunned, recover consciousness or those slaughtered without stunning will be exposed to the hazards and experience the related welfare consequences.
- During the slaughter processes, animals may be exposed to several hazards, which could have a cumulative effect on welfare consequences (e.g. water deprivation, insufficient space allowance, and an excessively high effective temperature will have a cumulative effect and exacerbate heat stress).
- Exposure to some hazards might persist during all processes and phases until the animal is rendered unconscious (e.g. food deprivation).
- Other hazards might be present only during one phase, but the welfare consequence might persist during the successive processes and phases until the animals are rendered unconscious (e.g. pain due to inappropriate handling).
- Most of the hazards are associated with lack of staff skills and training (inappropriate handling) and poor design, construction and maintenance of the premises. The lack of skills or lack of training of the staff working in the slaughterhouse is considered a serious welfare concern.

Some recommendations to address the previous welfare issues are the following [199, EFSA 2019]:

- Design, construction and maintenance of the premises and handling facilities should be based on understanding how cattle perceive their environment and meet their welfare requirements (e.g. thermal comfort, comfort for resting).
- Even in a well-designed and equipped slaughterhouse, training of staff is a key preventive measure to avoid hazards and mitigate welfare consequences: all processes of the slaughtering should be carried out by trained and skilled personnel. Staff should be trained to consider cattle as sentient beings, to have a good understanding of species-specific behaviour and to act accordingly during all processes.
- The welfare status (based on the welfare consequences) of the animal should be assessed at each phase of slaughtering to prevent and correct hazards and mitigate negative welfare consequences.

The following welfare issues have been reported as crucial during the stunning phase [199, EFSA 2019]:

- Consciousness is a prerequisite for the animals to experience pain, fear and distress. Therefore, animals that are not or ineffectively stunned or recover consciousness will be exposed to the hazards and related welfare consequences. Pain, fear and distress can be assessed indirectly by assessing the state of consciousness.
- Effective mechanical (excluding firearms) and electrical stunning methods require restraint of the body and the head that per se may impose additional pain and fear. These welfare consequences will persist during the restraining period until successful stunning.
- Ineffective captive bolt stunning is mostly due to the wrong shooting position and direction and inappropriate stunning parameters (bolt length, velocity, power, etc.).
- Inappropriate restraint of the head and lack of skilled operator can lead to the wrong shooting position and direction of the captive bolt.
- The pneumatically operated captive bolt guns are more effective than cartridge-powered guns, especially in heavy bulls.
- Non-penetrative captive bolt guns are less effective than penetrative captive bolt stunning methods.
- Ineffective electrical stunning is mostly due to wrong placement of the electrodes, poor electrical contact, excessively short exposure time, inappropriate electrical parameters.
- The duration of unconsciousness induced by head-only electrical stunning of cattle may not be sufficient to last until death occurs through bleeding.
- Irreversible stunning methods (e.g. head-to-body electrical stunning) have the animal welfare advantage of eliminating the risk of recovery of consciousness and associated pain, fear and distress.

Some recommendations to address the previous welfare issues are the following [199, EFSA 2019]:

- Optimum restraining of head and body is required to achieve effective stunning.
- Restraining methods or practices which cause severe pain and fear should not be used.
- Pain and fear associated with restraint should always be assessed by the use of ABMs.
- Animals should not be restrained if the operator is not ready to stun them immediately.
- Animals should not be stunned if the operator is not ready to bleed them immediately.
- To avoid animals recovering consciousness, irreversible stunning methods are recommended.
- When reversible stunning methods are used, bleeding should be applied without any delay to avoid recovery of consciousness.
- To monitor stunning method efficacy, the state of consciousness of the animals should be checked at each of the three key stages – i.e. after stunning, just prior to sticking and during bleeding.
- Animals ineffectively stunned or recovering consciousness should be stunned immediately with a backup method.
- The use of non-penetrative captive bolt guns for stunning cattle should be avoided due to higher incidence of ineffective stunning and shorter duration of unconsciousness when compared with penetrative captive bolt stunning.

3.3.1.1.3 Bleeding

EU animal welfare legislation dictates that stunning shall be followed as quickly as possible by a procedure ensuring death, such as bleeding. [21, COM 2009]. In any event, bleeding must be carried out before the animal regains consciousness. There are special provisions in the legislation which apply to slaughter according to certain religious rites. In the EU MSs, the religious authority on whose behalf slaughter is carried out is the competent authority for the application and monitoring of these provisions, operating under the responsibility of the official veterinarian.

Otherwise, all animals that have been stunned must be bled, by incising at least one of the carotid arteries or the vessels from which they arise. After incision of the blood vessels, no further dressing procedures or any electrical stimulation may be performed on the animals before the bleeding has ended. Bleeding also aids the preservation of the meat, by removing a breeding ground for microorganisms.

Carcasses are bled over a trough or tank, to collect the blood. In some slaughterhouses, the blood tanks are only large enough to hold the blood of a small number of animals, e.g. 10, to ensure that if one animal's blood is contaminated, or if a carcass is condemned after inspection by the veterinarian, only a small portion has to be disposed of.

The blood trough is normally fitted with a double drain, one opening for the blood to be pumped to a tanker for disposal and the other for wash-water. Removable plugs seal the openings when they are not in use. Some slaughterhouses have installed additional blood collection sumps at other parts of the process, such as at the legging platform where the back legs are skinned.

At cattle and pig slaughterhouses, some blood may be hygienically collected for human consumption, e.g. for black pudding or pharmaceutical use. Hygienic blood collection from pigs can be carried out by traditional bleeding, e.g. in small pans or a trough or by using hollow knives. The hollow knife is slightly broader than an ordinary knife and is double edged. The operator can hold the knife in place, or it can be fixed in position by a clamp or by a small hook fixed at its base. The blood runs from the hollow knife through the handle and a tube to a collection vessel. When bleeding is completed, the knife is placed back into its holding carousel for automatic cleaning and a clean knife is selected for the next animal. Bleeding/sticking knives can be washed, but not sterilised to the standards necessary to destroy all pathogenic organisms, especially TSE agents, in the interval between two kills [53, APC Europe 2001].

Typically, a total of between 2 litres and 4 litres of blood is collected from each pig and about 10-20 litres per head of cattle. After the collection of the initial flush of blood, the animals are hung over a blood trough to collect the remainder of the free-flowing blood. Whilst the use of hollow knives is considered to be a very good system for obtaining high-quality blood, it gives a lower yield of blood collection at this stage on the slaughter-line and therefore increases the potential for blood to continue to drip from the carcass, leading to contamination of waste water later [53, APC Europe 2001]. The lower yield is related to the back pressure associated with the use of the hollow knife and the time that the hollow knife is allowed to remain in the animal. In most cases, the time is limited to 20-40 seconds because of the speed of operation of the slaughter-line. In practice, hollow knives are only used in big slaughterhouses and only for the length of time required to obtain the quantity needed for the collection of food-grade blood. In addition, it is not possible for the slaughter operator to know whether the incision of the blood vessels has been accurate [67, EAPA 2002].

Typically, the blood collected is pumped from the trough to a refrigerated tank/tanker where additives, e.g. citric acid or sodium citrate, are added to prevent coagulation. The addition of 100 ml of a 20 % solution of sodium citrate per pig may be added automatically using a flow-meter. Alternatively, the fibrin which binds blood clots together can be removed by stirring with a paddle. Plate heat exchangers may also be used to chill the blood to a temperature of about 2 °C. The blood can be continually agitated in the tank [67, EAPA 2002]. In the UK, approximately 15 % of mammalian blood is chilled prior to collection and processing. The main reason for this is to maintain the functionality of the plasma proteins for use in pet foods for example. The storage of blood above 10 °C is reported to quickly lead to odour problems.

Some UK slaughterhouses use an electrical conditioning process to improve the meat quality for cattle, pig and lamb carcasses. At one slaughterhouse, pig carcasses are subjected to 600 V for 5 minutes on a carousel system. It is reported that bleeding with a hollow knife together with electrical stimulation, e.g. at 40 V for 1 minute, facilitates hide removal as well as improving the quality of hides and skins, due to earlier rigor mortis. It is reported that the pH of meat is reduced

from 7.0 to 5.6 in 2 hours instead of 18 hours. There is some debate about whether it may also help to drain the blood from the carcass.

Blood has the highest COD strength of any liquid effluent arising from meat processing operations. Liquid blood has a COD of about 400 g/l and a BOD of about 200 g/l. The containment of blood is therefore one of the most important environmental controls at a slaughterhouse. The spillage of blood is potentially one of the most environmentally harmful accidents that can happen. Spillage from blood tanks has occurred when blood trough pumps have been left on overnight during floor cleaning, thereby causing the blood tank to overflow. The blood may escape to local watercourses or cause problems in an on-site WWTP, due to shock loading. The risk of this can be reduced by installing a high level alarm on the blood tank, linked to an automatic cut-off device for the blood trough pumps. Here a ballcock hits an electrical switch and a solenoid activates a valve, which prevents any further addition [83, Durkan J. 2002].

During bleeding, blood coagulates on the base/walls of the trough. This is either hosed down and washed directly to the WWTP or in some slaughterhouses it is collected by shovels, squeegees or by vacuum suction and as much as possible is pumped to a blood tanker. Such coagulated blood can be rendered, but cannot be used in blood processing. In most slaughterhouses, the blood trough is pitched and curved so that partially congealed blood can be directed into the drain and to the blood tanker. If the coagulated blood is collected first, a few litres of water can, usually with the permission of the renderer, be used to rinse blood into the blood tanker. The plug in the drain leading to the WWTP is then opened and the whole trough is washed down with water.

Some slaughterhouses have traditionally allowed all or a significant proportion of the blood they collect to run to their WWTP. This has always been considered to be bad practice, due to the high COD and BOD and because it also removes the possibility of other routes for the use and/or disposal of blood being followed.

3.3.1.1.4 Hide and skin treatment

Whether hides/skins are salted or not may depend on customer requirements. If hides/skins can be delivered to a tannery and processed within 8-12 hours after slaughter they generally do not require any treatment at the slaughterhouse. They need to be chilled if they are to be processed within 5-8 days. For longer storage times, e.g. if they have to be transported overseas, then salting is reported to be the preferred option, due to the weight of ice and the energy consumption required for ice production and for refrigeration [76, Black et al. 2013].

If sheep/lamb skins and cattle hides are to be salted, they may be cooled first with cold water or chilled prior to being stacked flat and then salted, using sodium chloride, or alternatively they may be salted directly. After approximately 6 days, they are packed with additional salt and stored or transported to tanneries for leather production. The hides and skins are normally stored in cool conditions, at about 4 °C.

If trimming is undertaken before salting is performed [78, Anão M. 2002], this reduces the amount of salt consumption, and there is a subsequent reduction in waste water contamination at the slaughterhouse and, if the trimmings are used for the manufacture of gelatine, at the manufacturing installation too.

Salt in waste water is difficult to treat [101, COTANCE 2003]. Specific treatments for preventing or controlling salt emissions via waste water have not been identified. It has been suggested that this may be due to a lack of awareness of salt emissions. Dilution and not treatment appears to be the mechanism by which harm to watercourses and plant life is presently reduced.

The tanning industry reports that the washing of animals prior to slaughter is a questionable practice since animals should not be slaughtered in a wet condition for hygiene reasons. From the

tanning industry point of view, it is much better that animals are kept clean on the farm and delivered in a clean condition to the slaughterhouse [101, COTANCE 2003]. Veterinarians require animals to be clean and dry to prevent carcass contamination during the slaughter and dressing operations. A CEN standard on hide and skin preparation in slaughterhouses is in preparation. Hides and skins are reportedly often sold with, for example, legs, hooves and parts of heads still attached. It is claimed that tanneries do not have the variety of use and disposal routes for by-products available to them that slaughterhouses have. Fleshing is considered to be a skilled job, possibly not always appropriate to the slaughterhouse operation.

The tanning industry encourages chilling of hides/skins, but considers that salting cannot be phased out where the material is to be transported significant distances, so it encourages its careful execution, avoiding the use of excessive amounts of salt. Brining is not undertaken at slaughterhouses, although it is done at hide/skin markets or in tanneries. The routine use of biocides is considered to be unnecessary if preservation is undertaken correctly but they may have a role to play, e.g. for storage or transport in hot climates [82, COTANCE 2002]. Drying is not undertaken in Europe, but it is done in Africa. Icing is encouraged by the tanning industry. Irradiation is not known to take place at slaughterhouses. [82, COTANCE 2002].

Machines to remove hide and skin typically pull the hide/skin from the carcass. Two chains are hooked to the hide/skin and are then wound onto a drum to pull the hide/skin. Some sheepskins are removed manually, but automated removal is also common. The hides and skins are supplied to tanneries for the production of leather goods. In some slaughterhouses, the hides and skins are salted to improve preservation.

Knives and similar tools, such as flaymasters, which are pneumatic tools with guards commonly used to minimise flay cuts, are used to remove animal hides and skins. These have a tendency to become contaminated with faecal material. Care is taken to ensure that dirty knives are not be used for any operations where the carcass meat has been exposed. They must be decontaminated first by removing any debris and then, for example, dipping them in hot water at 82 °C for 10 seconds.

In some slaughterhouses, pig carcasses are skinned like cattle carcasses. Pigs are washed before the skin is removed using a hide-puller. The hide-puller is driven by a powerful motor or hydraulic piston and it pulls the skin off the carcass. The vertebral axis of the animal can be temporarily strengthened by brief electrical stimulation to tighten the muscles; otherwise, some hide-pullers can cause a separation of the vertebrae [5, University of Guelph 2000].

After the hides/skins are removed, the carcasses are conveyed to the part of the slaughter-line known as the clean slaughter-line for dressing and the hides/skins are taken to the hide/skin treatment area.

3.3.1.1.5 Evisceration

Evisceration involves manual removal of the respiratory, pulmonary and digestive organs. This is done by pulling out the bladder and the uterus, if it is present; the intestines and mesenteries; the rumen and other parts of the stomach; the liver and then, after cutting through the diaphragm, the plucks, i.e. the heart, lungs and trachea. The resulting offal is loaded into pans for inspection and transportation to the offal processing area. The heart, liver, kidneys and non-ruminant intestine may be sold for human consumption. At some pig slaughterhouses, the pancreas may be sold to pharmaceutical companies to produce insulin. Some edible fats and trimmings may be rendered to produce lard and dripping.

Australia and New Zealand developed large-scale automated systems for cattle and lamb evisceration, respectively [5, University of Guelph 2000].

Offal, including the lungs and trachea for all animals and the first stomach for cattle and sheep, can be used in the production of pet food. For cattle and sheep, the first stomach is cut open on a table and the contents are removed using either a wet or dry process. In the wet process, it is cut open in a water flow to produce a slurry which is discharged over a screen and then pumped to a holding area. For veal cattle, bulls less than 1 year old and cows, the first stomach contents weigh up to 10 kg, 40 kg and 50 kg, respectively [64, Sorlini G. 2002].

In the dry process, the first stomach is opened without water. The contents are removed manually and transported by a pneumatic system or screw conveyor to a collection point. First stomach contents are normally disposed of by spreading on agricultural land, subject to veterinary approval and the nutritional needs of the soil. Some companies use a piston compactor to reduce the volume of the contents for easier handling. After dry contents removal, the first stomach is washed in running or recirculated water.

The majority of slaughterhouses use a compressed air ring main to power equipment. In such cases, it is standard practice to use this to power a pneumatic system to blow the first stomach contents to the collection point. Compressed air at approximately 100-273 kPa (15-40 psi) can be used to blow paunch manure to the collection trailer. A piston compactor can be used to reduce the volume.

In some slaughterhouses macerator equipment is used to chop, wash and spin-dry the remaining offal prior to supply to the rendering company. This can reduce the offal volume by over 50 %.

It is not necessary to wash the carcasses in the evisceration area, although it is sometimes undertaken if there is contamination present from damaged viscera.

3.3.1.1.6 Splitting

After evisceration, the cattle, mature sheep (not lambs, because it is not necessary to remove the spinal cord as a TSE precaution) and pig carcasses are split along the spine using a saw. Water is sprayed onto the blade to remove any bone dust which is generated. The spinal cords of the cattle and mature sheep are then removed from the carcass and disposed of as SRM. Some slaughterhouses use a vacuum system which sucks the spinal cord material to the SRM waste skip. In other slaughterhouses, the spinal cord is removed manually and the cavity is cleaned using a steam spray/suction device. In Italian pig slaughterhouses on the same sites as cutting plants, the carcasses are cut into portions weighing a maximum of 15 kg, before chilling, for the production of typical Italian cured products [57, Italy 2002].

In some slaughterhouses, the carcass is given a final rinse with low-pressure potable water before chilling or freezing. At every stage of production the meat is inspected visually to maintain quality standards.

For cattle which are known or suspected TSE sufferers at the time of slaughter, the carcasses are sawn in two, lengthways, ensuring that the spinal cord remains completely enclosed and intact and are sent for rendering followed by incineration or direct incineration.

If the correct diameter and thickness of saw blade is selected for the carcass-splitting saw and the blade is maintained sharp, then the noise levels will be reduced and less bone dust will end up in the waste water. Bone sawdust can cause a high phosphorus load in the waste water.

3.3.1.2 Additional applied processes and techniques for cattle slaughterhouses

A general scheme for the slaughtering of cattle is shown in Figure 3.13.

Pre-cooling in a tunnel (versus batch-cooling in a refrigeration room) can reduce cooling waste and improve the management of the cooling process, but has a higher energy consumption [118, Denmark 2015].

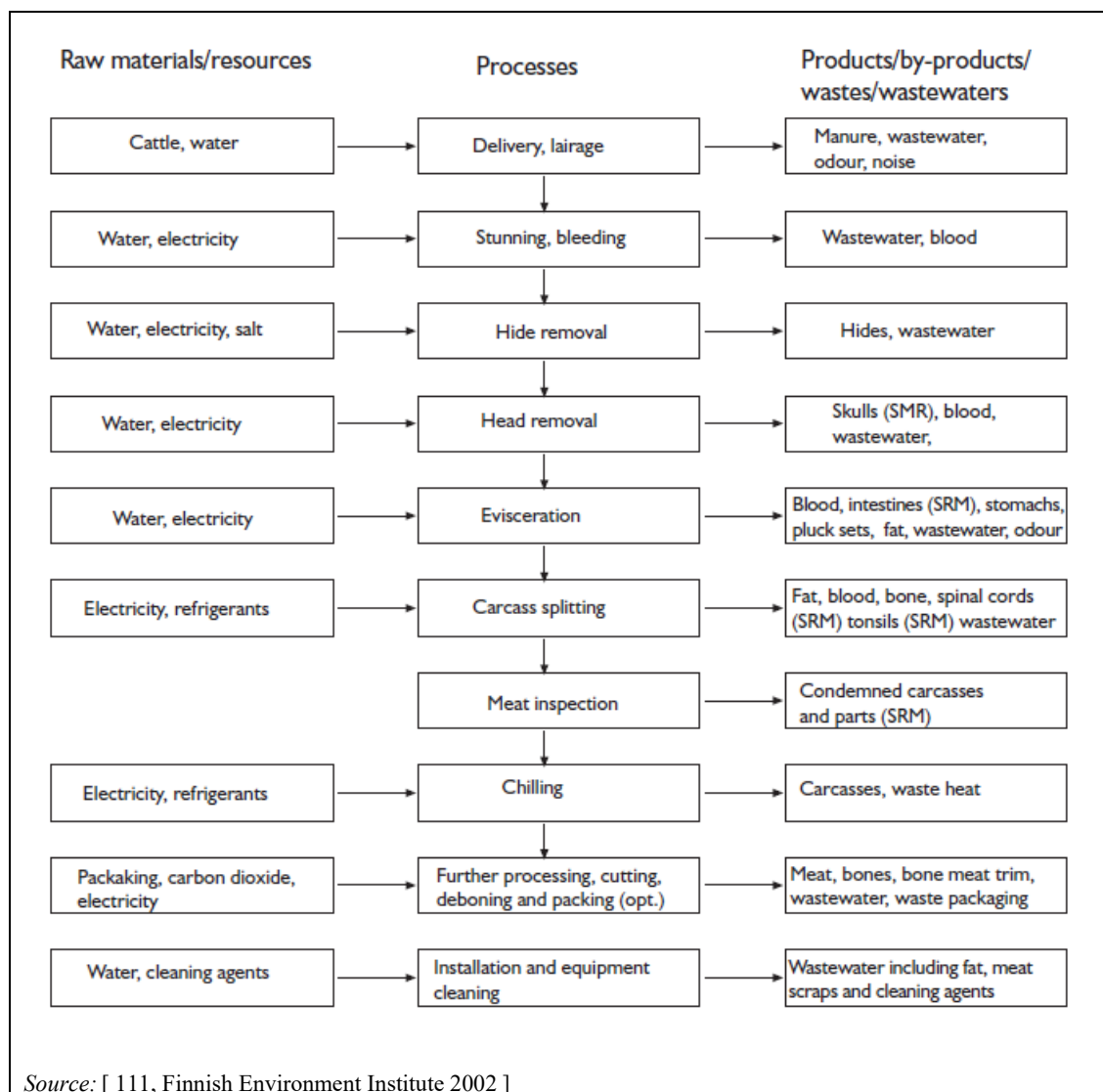

Figure 3.13: A typical flow scheme of cattle slaughtering

3.3.1.2.1 Head and hoof removal for cattle

After the bleeding of cattle, the animals' forelegs, tail and udder/testicles are manually removed using knives. At some cattle slaughterhouses, the operator cuts a slit in the neck to allow further blood to escape, before cutting the head off. The tongue and cheeks may also be removed for human consumption, except in certain MSs where cheeks are SRM [19, COM 2000]. Cattle heads are washed, inspected and disposed of.

Hooves are traditionally supplied for use in the manufacture of glue but may also be ground for use in pet food. They may also be used to produce horn meal fertiliser.

3.3.1.3 Additional applied processes and techniques for pig slaughterhouses

A general scheme for the slaughtering of pigs is shown in Figure 3.14.

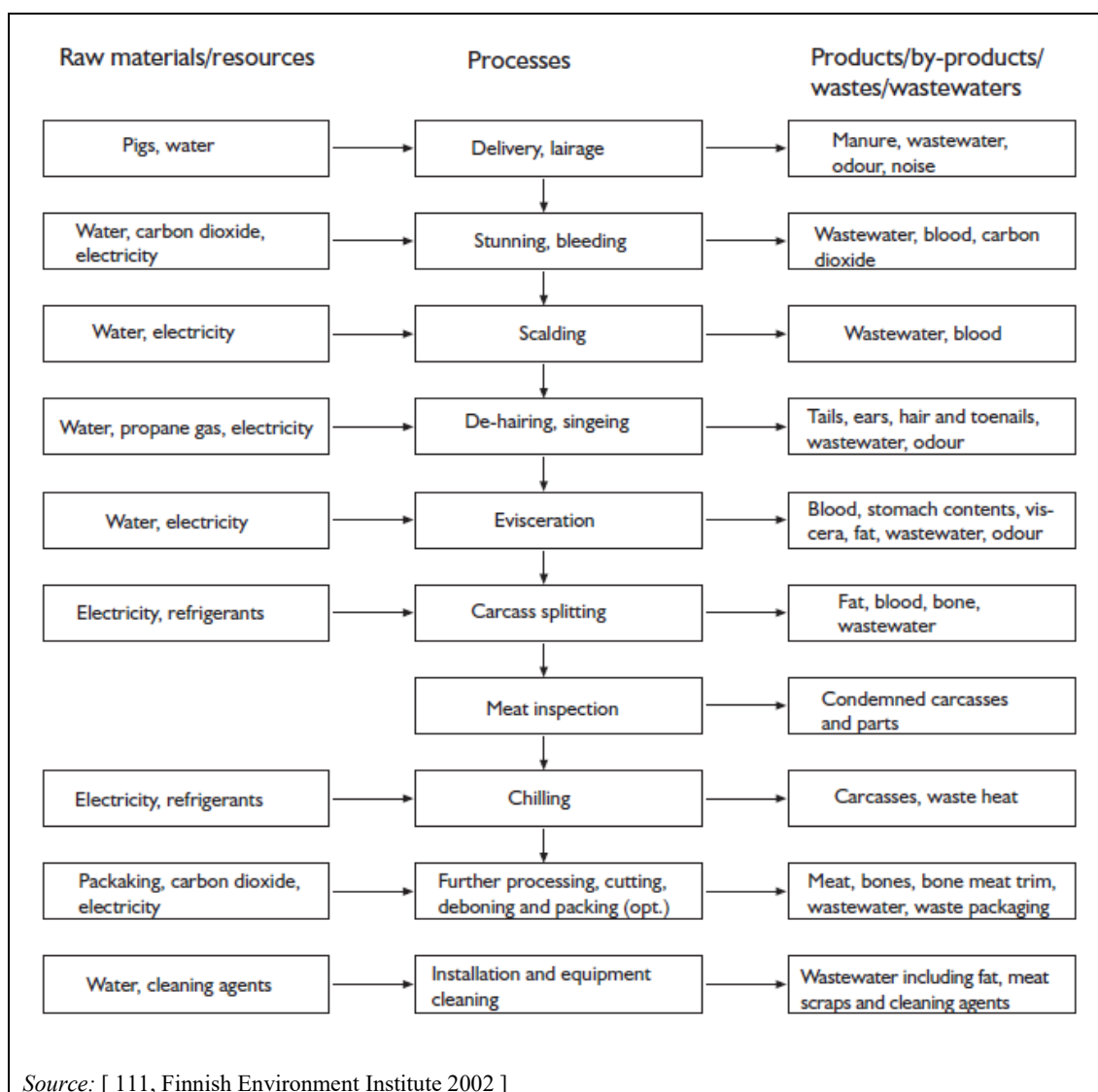

Figure 3.14: A typical flow scheme of pig slaughtering

3.3.1.3.1 Pig scalding

Pig carcasses are normally passed through a series of unit operations to remove the bristles. Traditionally the pig carcass is passed through a static or rotary scalding tank filled with water between 58 °C and 65 °C for 3-6 minutes to loosen the bristles and toenails. Under normal conditions, there is little or no heat penetration into the underlying flesh, so the meat quality is unaffected. Scalding at this temperature for longer than 6 minutes damages the skin. Lime salts or a depilatory agent, such as sodium borohydride, may be added to the water to facilitate loosening of the hair. A flap placed at the exit of the scalding tank can be used to collect and return water dripping from carcasses.

For a slaughterhouse processing about 100 pigs per hour, a typical static scalding tank would be about 4 metres long, 1.7 metres wide and 0.8 metres deep and would contain about 5 500 litres of water. A typical rotary scalding tank may contain about 2 500 litres of water and hold up to 14 carcasses at a time. Some large slaughterhouses use a conveyor system to drag the carcass through a longer tank with countercurrent water filtration and recycling. In Italy, because pigs are bigger, a typical scalding tank is longer, i.e. up to 10 metres long and it may contain 12 000 litres of water [57, Italy 2002].

Steam heating is normally used to maintain the temperature in the scalding tank and continuous make-up water is required to balance drag-out, which drips onto the floor and into the de-hairing machine. The scalding process produces some steam and odour.

Debris and sludge build up in the scalding tank during the day. It is common practice to empty the water and sludge directly into the site waste water drainage system at the end of production.

Alternative scalding methods may involve the use of either condensation or steam. Microbial contamination can be minimised by the use of steam [5, University of Guelph 2000]. Condensation/steam scalding uses humidified air. The heat is transferred to the carcass surface through the condensation of steam. The heat and moisture are transferred to the scalding air by the atomisation of hot water in the circulating airflow. This process can maintain a constant temperature and 100 % humidity under varying loads, which is crucial for good scalding performance.

Figure 3.15 shows a generic pig slaughterhouse layout showing the processes from reception up to the cooling tunnel.

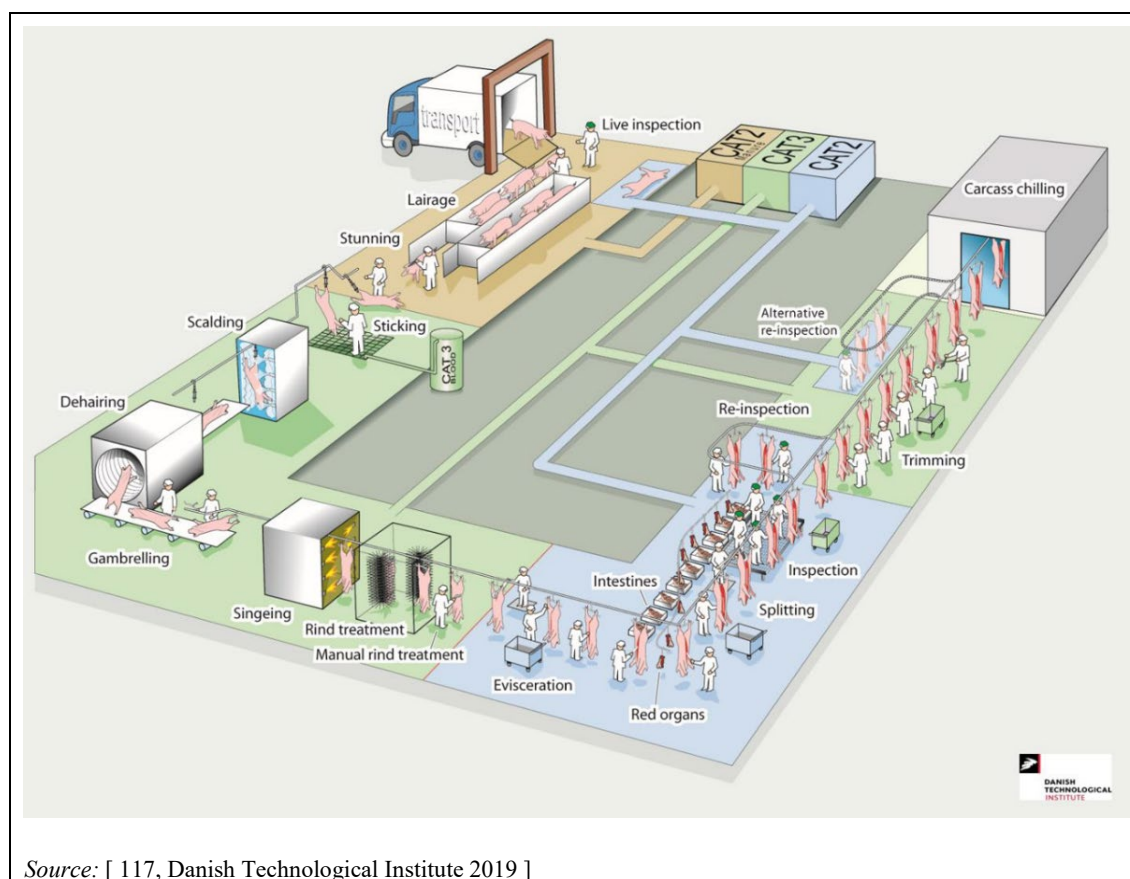

Figure 3.15: Generic pig slaughterhouse layout

3.3.1.3.2 Pig hair and toenail removal

An automatic de-hairing machine is used to remove bristles and toenails from pig carcasses. This comprises a number of rotating rubber flails, or similar, which brush or scrape the surface of the carcass.

In some de-hairing machines, the carcasses are tumbled two at a time horizontally between two sets of rubber flails, with a water spray from above to wash the hair out of the bottom of the machine. The water spray is used to flume hair and toenails to a primary screen. In some

slaughterhouses, toenails are collected dry and sent for rendering. In Denmark and Ireland, hair and toenails are rendered [108, Clitravi - DMRI 2003], [83, Durkan J. 2002].

In some slaughterhouses, the fluming water is recycled back to the de-hairing machine and the water is discharged to the site waste water drainage system once a day. In others, the water spray uses water from the once-through cooling system of the conveyor rail which is used to transport the pigs through the singeing unit.

3.3.1.3.3 Pig singeing

Pig carcasses are singed to remove residual hair which has not been removed by the de-hairer, to provide a firmer skin texture and to eliminate microorganisms. Singeing units must only be fuelled with natural gas or fuels comparable to natural gas in terms of odour and other emissions [181, VDI 2020]. Propane is used in preference to natural gas because of the higher flame temperature, although natural gas is sometimes used if the slaughterhouse has an existing supply. Singeing should be optimised to reduce odour emissions and energy consumption (see Section 3.3.4.3.1).

If the pig meat is to be used to make bacon, the carcass is given a 'heavy singe', by leaving the burners switched on continuously during the production run. This produces the rind. In some slaughterhouses, additional singeing may be carried out manually using portable gas burners. If a heavy singe has been applied, the carcass undergoes rind treatment. If not, it is rinsed in cold water to cool the carcass.

If the meat is for the production of typical Italian cured products, a light singe is applied.

Singeing can also be carried out in an oven, which also has an impact on the finished product's characteristics and product hygiene [118, Denmark 2015].

3.3.1.3.4 Rind treatment

After singeing, pig carcasses are passed through a scraping machine to polish the skin and to remove singe hair and other debris. The polisher consists of sets of rotating rubber flails, similar to the de-hairing unit. At some slaughterhouses, additional carcass polishing may be carried out manually using handheld scrapers. Water is applied during rind treatment to cool the carcasses, soften the outer layer of skin and to rinse the bits of skin away.

The degree of the rind treatment, and thus the water consumption required for the rind treatment, depends on the selected degree of singeing - since the singed surface is removed during the process. The process is therefore dependent on the same choices that are made in connection with singeing in an oven or flaming [118, Denmark 2015].

3.3.1.3.5 Chilling of pig carcasses

The choice of cooling method has an impact on the hygienic quality. Product hygiene has an influence on how long the meat products can remain fresh and thus the distance the products can be exported. A comparison of the most commonly used chilling methods in Danish pig slaughterhouses is shown in Table 3.6.

Batch chilling

Batch chilling uses a chill room with rails or walking beams as the processing area. All batch chilling is separated from each other to avoid air infiltration between cells in operation and cells out of operation. Each cell has a capacity of 2 hours' production. Batch chilling uses air as

transport media. A uniform air distribution will keep the heat transfer coefficient high. The combination of air velocity and air temperature determines the process time.

The advantage of using the batch chilling process is that chilling and equalisation of carcasses take place in the same room. The process is simple to establish and the cells can be loaded either manually or automatically.

If the air distribution is not uniform, it is disadvantageous to use the batch chilling process as it is impossible to get uniform equalised carcass temperatures. It is very important to ensure space around the carcasses. If some carcasses touch each other for example, this will prevent the heat transfer from the touching areas, which will become warm for a long time and thus increase the risk of damaging the meat quality (PSE and bacterial growth).

Another disadvantage is the development of condensation, caused by vapour from the carcasses, on building surfaces (primarily ceilings) and steel structures, especially in the first part of the cooling process, and therefore the risk of condensate dripping onto products.

Water spray chilling

By evaporative chilling – water spray chilling or mist cooling – water is applied to the carcass at the same time as it is swept over by air with moderate velocity and temperature. Evaporative chilling uses the thermophysical characteristic that an increase of the carcass surface water activity improves the overall heat transfer coefficient and reduces the evaporation of juice from the carcass. In practice, the process is built into a chilling tunnel with conveyor, evaporators and fans and up to 35 water spray cabinets for moistening the carcasses. Placement of the water spray cabinets depends on how fast the water activity on the surface decreases. As the carcass surface temperature is highest at the beginning of the process, the spraying cabinets are placed close to the first part of the tunnel.

The advantage of using water spray chilling is the low shrinkage and the high process temperature. The high process temperature reduces the energy consumption for compressor operations and reduces the capacity needed. At high process temperatures, it is possible to avoid surface freezing.

The disadvantage of using water spray chilling is that it is a very slow process, which needs huge tunnel dimensions. If the water activity is high on the carcass surface when it leaves the tunnel, this will cause increased bacterial growth. The water consumption is high, and only usage of pure water of drinking quality is allowed. Purifying water with chloride compounds is not allowed in many countries. The wet surface increases the black bone problem.

Another disadvantage is the consumption of cleaning agents, water and manpower during the daily cleaning of the spray chilling process area. Besides this, requirements regarding the hygienic and cleanable design of the area are difficult to achieve in practice due to the complexity of the mechanical and structural system necessary. Insufficient cleaning increases the risk of listeria growth.

Blast chilling

Blast chilling uses the thermophysical characteristic that an increase of the boundary layer by a high air velocity at the carcass surface increases the heat transfer coefficient. This increases the carcass heat extraction and, together with a low air temperature, the surface temperature drops, which establishes maximum conductive heat transfer in the carcass. The blast chilling process is built into a tunnel with conveyor, evaporators and fans. The air velocity is high – 3 m/s to 4 m/s in the free cross-section.

The advantage of using blast chilling is the low shrinkage and the small tunnel dimensions. The low process temperature causes surface freezing, which improves the food safety, as surface freezing kills non-cold-permissive bacteria.

The disadvantage is a low process temperature, which increases the energy consumption for compressor operations and increases the capacity needed. The black bone problem caused by

surface freezing can be eliminated by a short tempering zone at the end of the chilling process, which will cause the surface temperature to rise to equalisation room temperature.

Table 3.6: Comparison of chilling processes for pig carcass chilling

Subject	Batch chilling	Water spray chilling	Blast chilling
Chilling temperature (°C)	-3	-5	-24 - -12
Air velocity (m/s)	0.5-1	0.2-0.5	3-4
Chilling time (h)	7-9	3-4	1-1.5
Equalising time (h)	8-10	15-17	16-18
Total processing time (h)	18-20		
Weight loss (%)	1.6-1.8	1.0-1.2	
Mean equalised temperature (°C)	5		
Primal cut temperature prior to cutting	Slight difference	Uniform	
Risk of Pale Soft Exudative muscles	Slow temperature reduction. The temperature-dependent PSE level will not be reduced.		Fast temperature reduction. The temperature-dependent PSE level will be eliminated.
Risk of Pale Soft Exudative spots	It can be reduced by proper carcass spacing in the coolers.		Lower compared to processes with slow temperature reduction.
Drip loss (poor water-holding capacity)	The temperature-dependent drip loss: High level due to slow temperature reduction.		The temperature-dependent drip loss is eliminated due to fast temperature reduction.
Bacterial growth on carcass surface	Increased growth due to slow temperature reduction.	Increased growth due to wet surface and slow temperature reduction.	Reduction due to low temperature and fast temperature reduction.
Bacterial load	No surface freezing. <i>Camphylobacter</i> level unchanged.	No surface freezing: <i>Camphylobacter</i> level unchanged. Wet surroundings combined with insufficient cleaning increase the risk of <i>Listeria</i> contamination	Bacterial reduction due to surface freezing. Reduces the <i>Camphylobacter</i> level 1 log unit.
Discolouration of the back bones	No. Normally no risk due to chilling time, if the air distribution and temperature is uniform.	Yes. Risk of increased level. Can be reduced by drying the surface.	Yes. Risk of increased level. Can be reduced by a tempering zone before leaving the chilling zone.
Electricity consumption (kWh/pig)	1.0	1.6	2.0–2.9
Process area	Space for the kill of the day. Area index 100	Space for 4 hours kill + space for equalisation. Area index 180	Space for 1.5 hours kill + space for equalisation. Area index 105
<i>Source: [118, Denmark 2015]</i>			

3.3.1.4 Additional applied processes and techniques for sheep slaughterhouses

Sheep and lambs are delivered by trucks to slaughterhouses and led to the lairage area. Hereafter they are stunned with a penetrating/non-penetrating captive bolt device or by electricity. Thereafter they are hung and stuck/cut so bleeding can occur. Approximately 1-2 kg of blood per animal is relieved, which corresponds to 60 % of the total blood mass per animal. Afterwards their hide (for leather goods), stomach, intestines (for animal feed), and plucks (mainly for human consumption) are removed. In the end, approximately 21 kg/head slaughtered weight is showered with water to remove blood and fat residues and sent for cooling. Later they can be sold as an entire carcass, divided into halves or smaller parts [110, Nordic Council of Ministers 2016].

3.3.1.4.1 Head and hoof removal for sheep

See Section 3.3.1.2.1.

3.3.2 Current consumption and emission levels

3.3.2.1 General issues

3.3.2.1.1 Energy consumption

Chilling

Refrigeration systems affect the environment through the energy they consume and the effect they can have if refrigerants leak to atmosphere. Making the plant as energy-efficient as possible will minimise its environmental impact [85, ETSU 2000].

3.3.2.1.2 Water consumption

Animal reception and lairage

For hygiene reasons, animal delivery vehicles are washed down after each delivery. At most installations dedicated hose pipes are provided for this purpose. Most slaughterhouses do not charge for this water as they realise that the costs would be passed back to them in the form of increased delivery charges. HPLV hoses and spray guns can decrease water consumption, but their initial investment cost is greater than traditional hoses. It is reported that they are seldom used because delivery drivers do not generally treat them with care, e.g. they are left lying in the yard where vehicles drive over them [4, WS Atkins-EA 2000]. The use of hoses suspended from an inertia reel device, together with adequate training and supervision of drivers, may make their use more widespread and cost-effective.

To reduce water wastage, some large slaughterhouses have installed a metered water dispenser. Some meters take coins and others operate by inserting a token that is given to the driver on arrival. A driver can request an additional token if he is unable to finish cleaning his vehicle with the specified amount of water. The metered system has reportedly reduced water consumption [4, WS Atkins-EA 2000].

3.3.2.1.3 Noise

Animal reception and lairage

The lairage is one of the main sources of noise at slaughterhouses due to vehicle movements and animal noises during unloading. Cattle and sheep are generally fairly quiet, but pigs may be noisy, particularly during unloading and marshalling operations.

Splitting

Carcass splitting is one of the main sources of noise in a slaughterhouse. Noise levels of about 95 dB(A) have been measured. Further noise is produced when the standard cuts are made. The sound may be detectable outside the building. In addition, the saw operator and anyone in the near vicinity have a significant risk of contracting noise-induced hearing loss and health and safety legislation requires this risk to be minimised.

Chilling

The refrigeration plant is operated continuously and the condensing units, compressors and cooling towers associated with it can be a source of noise. Refrigerated trucks parked outside slaughterhouses can sometimes lead to noise problems if the refrigeration is powered from the truck engines. Many slaughterhouses provide mains power cables to power the refrigeration unit, thereby reducing the noise levels.

3.3.2.1.4 Emissions to water

Animal reception and lairage

Washing the vehicles and the lairage area can introduce organic material; inorganics, e.g. ammonia, phosphorus and solids; oils/fats/grease and solids into the waste water [1, EPA 1996].

Lairage manure, urine and wash-water are high in nutrients and can be collected for agricultural use as a fertiliser, provided specific conditions are met [4, WS Atkins-EA 2000]. At some slaughterhouses, clean water from other process areas, e.g. from chill vessels and carcass refrigeration rooms, as well as cooling water and steam condensate, is used to provide a primary washdown of lairage areas [4, WS Atkins-EA 2000].

Bleeding

Blood collected for blood processing tends to be collected more carefully and hygienically than that destined for rendering, so less may contaminate the waste water at the bleeding stage of the process. Less stringent hygiene requirements apply to blood which can be rendered, so if it is collected from floors, the floors have to be washed and the waste water volume and contamination are consequently increased. Hollow knives used to collect blood for food or pharmaceutical use reduce spillage, but the back-pressure they cause means that they also capture less blood than when an animal's throat is cut and natural bleeding occurs. Hollow knives typically collect 75 % of a pig's blood. The remaining blood is then released later in the process and the degree of contamination it causes depends on the speed of the line and the blood collection arrangements along the line. Collection figures of 23 % along the line, for rendering, with the final 2 % going to the WWTP, have been reported [53, APC Europe 2001].

Blood has the highest COD strength of any liquid effluent arising from meat processing operations. Liquid blood has a COD of about 400 g/l and a BOD of about 200 g/l. Congealed blood has a COD strength of about 900 g/l. If the blood from a single cattle carcass was allowed to discharge directly to a water company sewerage system the COD effluent load would be equivalent to the total sewage produced by 50 people on an average day [4, WS Atkins-EA 2000]. Blood has a total nitrogen content of approximately 30 g/l. It has been reported that retention of the blood is by far the most successful way of minimising waste water contamination in a slaughterhouse [42, Tritt W. P. and Schuchardt F. 1992].

Even if blood is collected carefully, i.e. by positioning the animal over the collection pit for the duration of the sticking procedure and allowing enough time for completion of the bleeding before the carcass is moved on, it has been reported that there may be dripping blood losses of up to 0.5 litres per pig (5.4 l/t carcass) and 2 litres per head of cattle (6.2 l/t carcass) [29, Germany 2001]. Collecting the blood before the carcass moves away from the sticking area so that it does not drip as it moves down the slaughter-line adds time to the overall process. It has

been reported that the additional time taken is compensated for, because the blood collected for processing has a value; otherwise, there is a charge for its removal as waste.

It has been reported that 30.5 kWh/t of electrical energy is used to refrigerate raw blood to around 5 °C [75, Woodgate S. 2002].

Evisceration

The wet emptying of stomach and intestinal contents can contribute 20 % of the total BOD in screened waste water from a slaughterhouse and approximately 15 % of the nitrogen [23, Nordic 2001]. In Danish slaughterhouses, total water consumption levels between 800 litres and 1 200 litres and 4.4 kg to 5.2 kg BOD per tonne of cattle carcass have been reported for cleaning stomachs and intestines. It has been reported that in Germany 30 % of the total waste water and organic contamination originates from stomach washing [42, Tritt W. P. and Schuchardt F. 1992].

In those slaughterhouses where macerator equipment is used to chop, wash and spin-dry offal prior to supply to the rendering company, the resulting cost savings usually outweigh the increased energy and effluent costs. The cost benefits of this approach result from the reduced volumes of waste for disposal. If offal was cut and washed the tallow colouring during rendering would be reduced and its value could increase. Macerator equipment usually consists of hook-shaped blades set to counter-rotate against themselves, or to rotate against fixed anvils. The cut offal is then washed in a rotating mesh drum. The equipment needs to be maintained regularly to optimise the speed and separation of the blades. If the blades are kept in good condition this will optimise the efficiency of the cutting operation and reduce the amount of waste offal, which goes on to become mixed with the wash-water [4, WS Atkins-EA 2000].

The cleaning of secondary process areas where, for example, stomach washing, tripe blanching and sausage skin production are carried out can lead to emissions to water containing organic material; inorganics, i.e. phosphorus, ammonia and solids and oils, fats and grease [1, EPA 1996].

The first stomach contents are about 75 % water, weigh about 15-20 g per head of cattle, and produce a slurry with a COD of over 100 g/l [4, WS Atkins-EA 2000].

Evisceration processes are carried out dry, but water is used for rinsing, knife sterilisation, the sterilisation of other equipment and for cleaning. The removed parts and the carcasses are rinsed with water to remove blood and other impurities. The introduction of water not only increases water consumption and water contamination, but it also potentially masks microbiological contamination, by removing potential visible signs.

The fat contained in the waste water from slaughterhouses is mainly produced during evisceration [29, Germany 2001] and intestine washing.

The rumen contents (paunch) of fully grown cattle amount to 40-80 litres per head (wet) [29, Germany 2001].

Blood drips from the carcasses during evisceration.

Hide/skin treatment

Salting using sodium chloride is the most common method of hide and skin preservation. Excess salt which spills off the salting table or is dropped during hand salting may be swept up and reused. If it is unacceptably contaminated it is normally disposed of, by incineration. Salinity can reduce the efficiency of the WWTP and, unless there is a naturally saline watercourse for receipt of the treated waste water, the salt content can have adverse effects on plant growth. The presence of salts affects plant growth by osmotic effects, due to the concentration of salt in soil water; the specific ion toxicity, caused by the concentration of an individual ion and the soil particle dispersion caused by high sodium and low salinity. Under these conditions, plants expend more

of their available energy on adjusting the salt concentration within the tissue to obtain water from the soil, so less is available for plant growth [51, Metcalf and Eddy 1991].

3.3.2.2 Cattle slaughterhouses

This section presents data for installations exclusively slaughtering cattle.

3.3.2.2.1 Energy consumption

3.3.2.2.1.1 Specific net energy consumption in kWh/tonne of carcass

Figure 3.16 shows data (from installations participating in the data collection, for the years 2016 to 2018) in relation to total specific net energy consumption in kWh/tonne of carcass at installation level, as well as the techniques applied to reduce energy consumption.

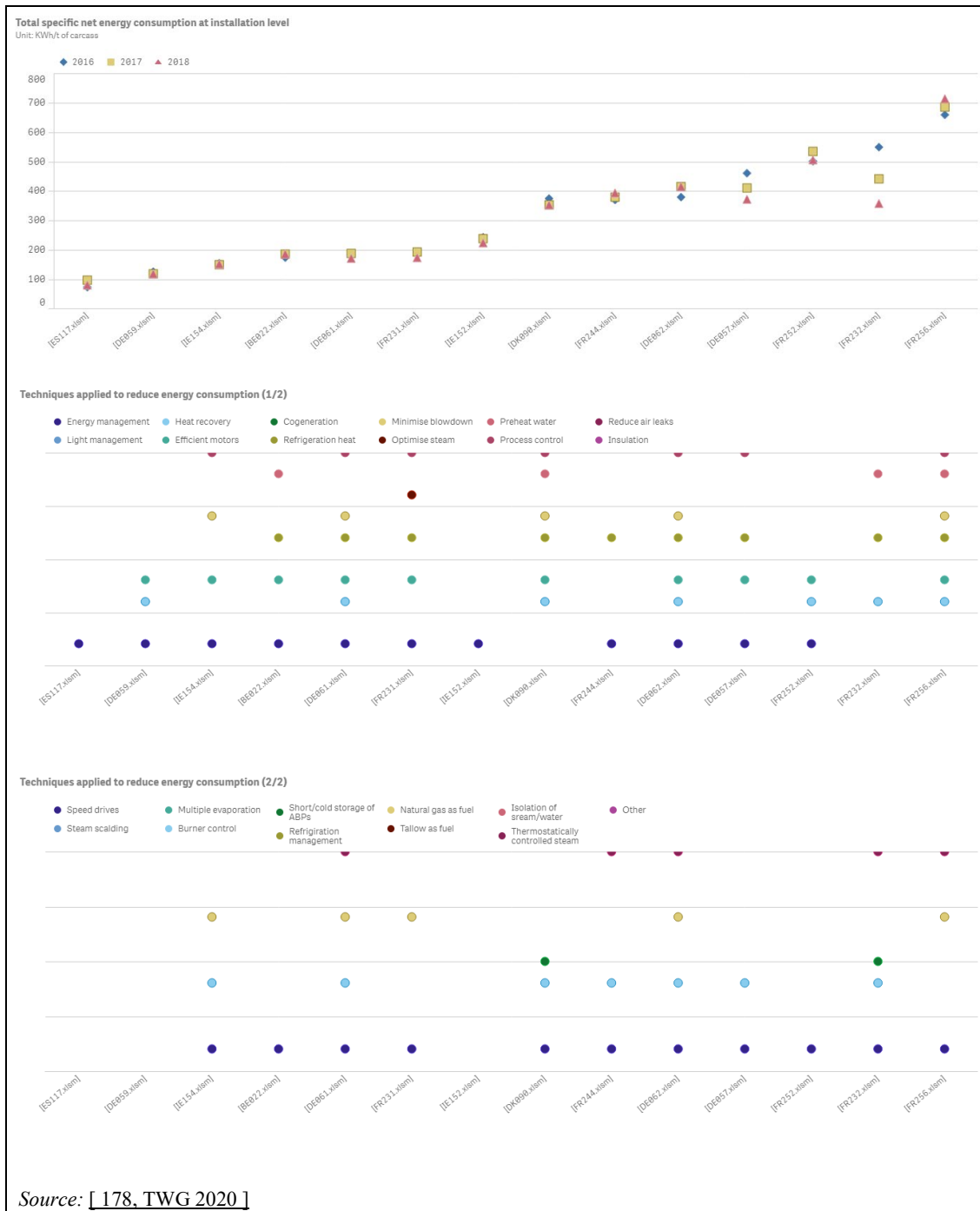

Source: [178, TWG 2020]

Figure 3.16: Specific net energy consumption (kWh/tonne of carcass) and applied techniques to reduce energy consumption in cattle slaughterhouses (installation level)

Figure 3.17 shows data (from installations participating in the data collection, for the years 2016 to 2018) in relation to total specific net electricity and heat consumption in kWh/tonne of carcass at installation level.

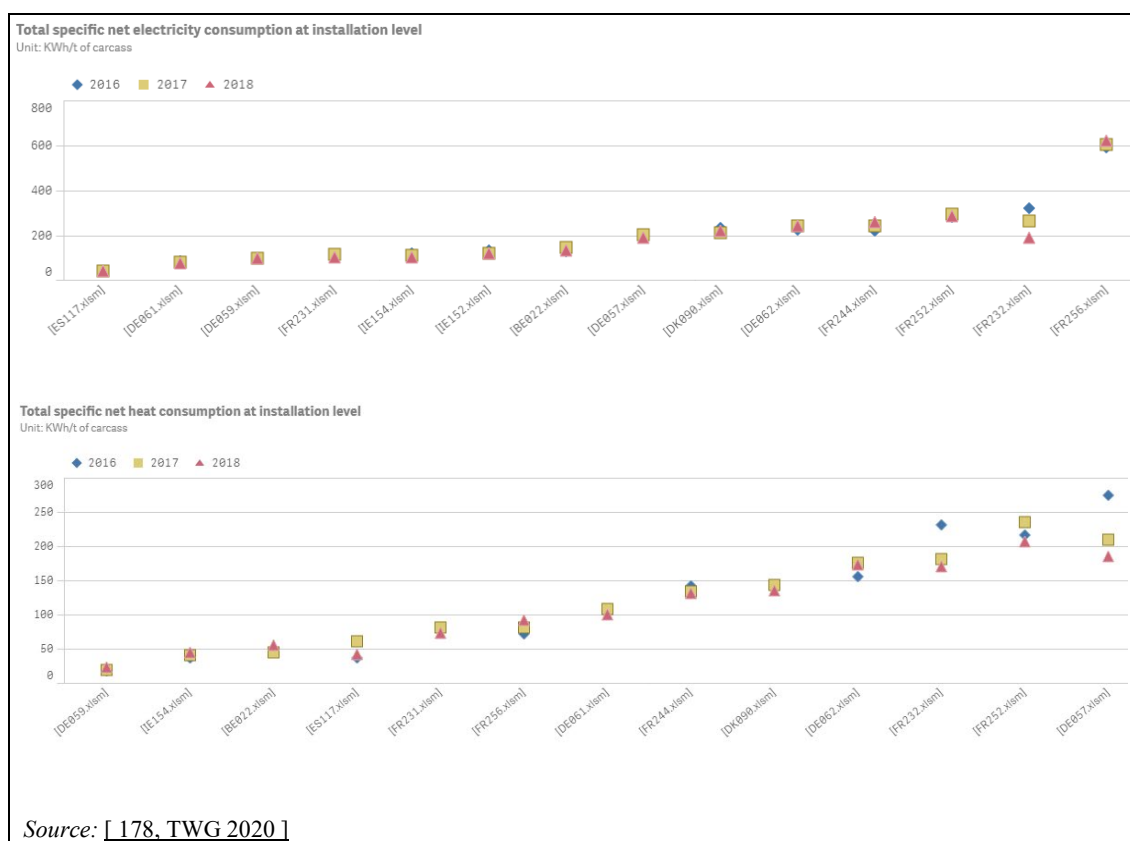

Figure 3.17: Specific electricity and heat consumption (kWh/tonne of carcass) in cattle slaughterhouses (installation level)

Figure 3.18 and Figure 3.19 show the specific net energy consumption (from installations participating in the data collection, for the years 2016 to 2018) in kWh/tonne of carcass in various cattle slaughterhouse processes.

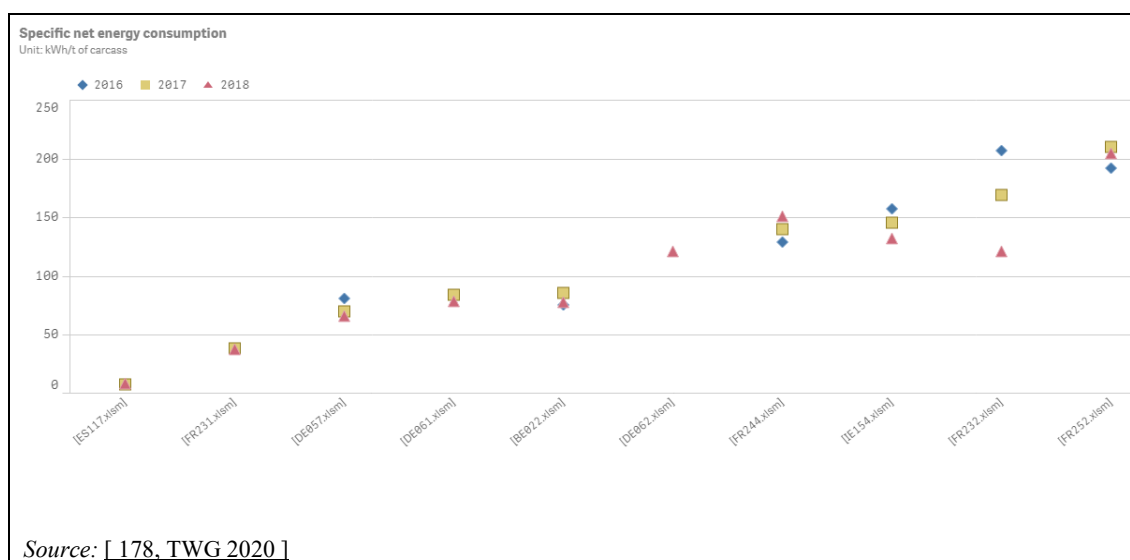

Figure 3.18: Specific net energy consumption (kWh/tonne of carcass) in cattle slaughterhouses for cooling systems

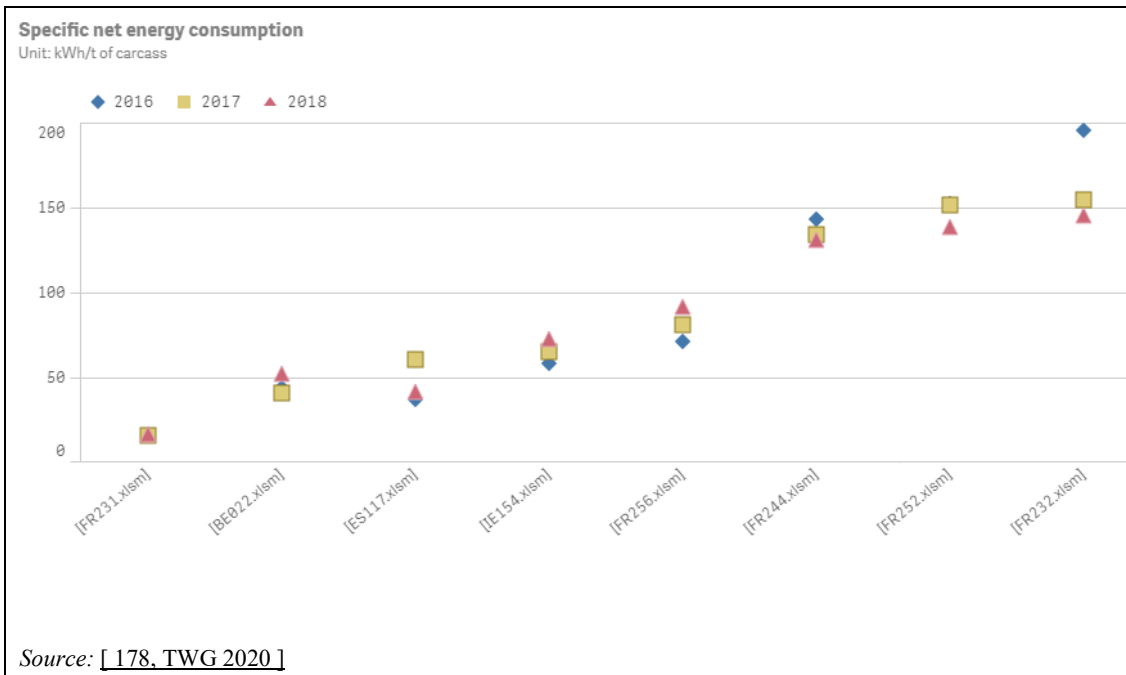

Figure 3.19: Specific net energy consumption (kWh/tonne of carcass) in cattle slaughterhouses for production of hot water for cleaning and disinfection

3.3.2.2.1.2 Specific net energy consumption in kWh/animal

Figure 3.20 shows data (from installations participating in the data collection, for the years 2016 to 2018) in relation to total specific net energy consumption in kWh/animal at installation level, as well as the applied techniques to reduce energy consumption.

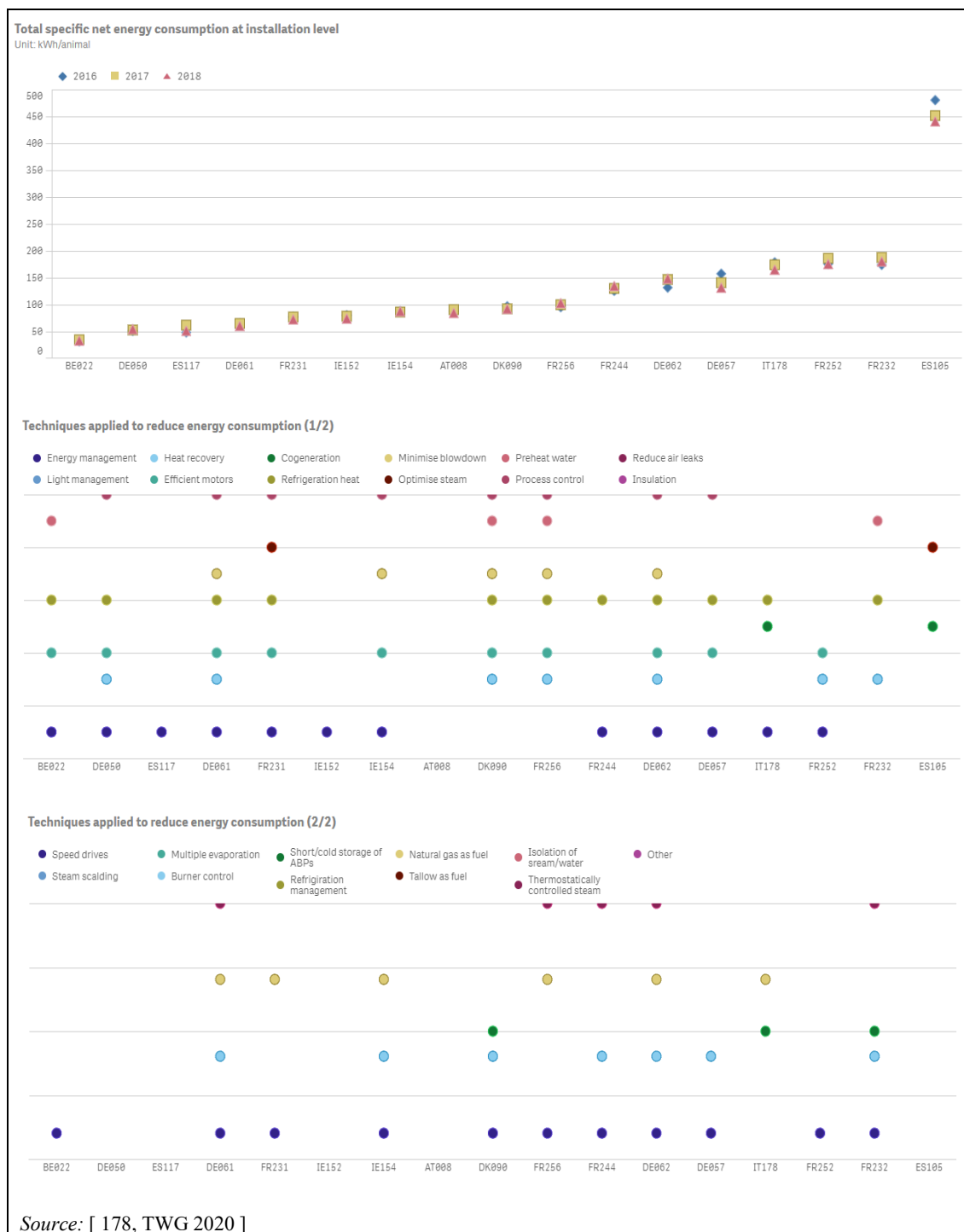
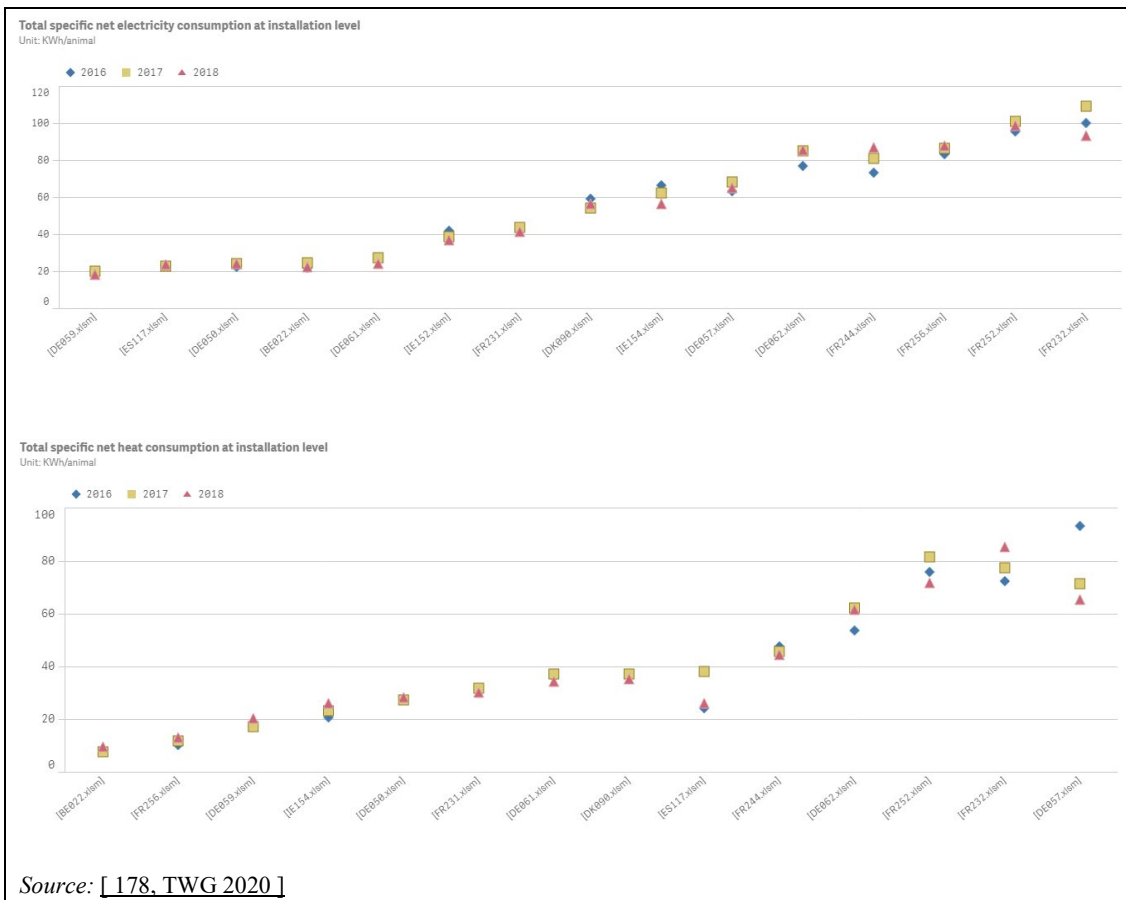

Figure 3.20: Specific net energy consumption (kWh/animal) and applied techniques to reduce energy consumption in cattle slaughterhouses (installation level)

Figure 3.21 shows data (from installations participating in the data collection, for the years 2016 to 2018) in relation to total specific net electricity and heat consumption in kWh/animal at installation level.



Source: [178, TWG 2020]

Figure 3.21: Specific net electricity and heat consumption (kWh/animal) in cattle slaughterhouses (installation level)

Figure 3.22 and Figure 3.23 show the specific net energy consumption (from installations participating in the data collection, for the years 2016 to 2018) in kWh/animal, in various cattle slaughterhouse processes.

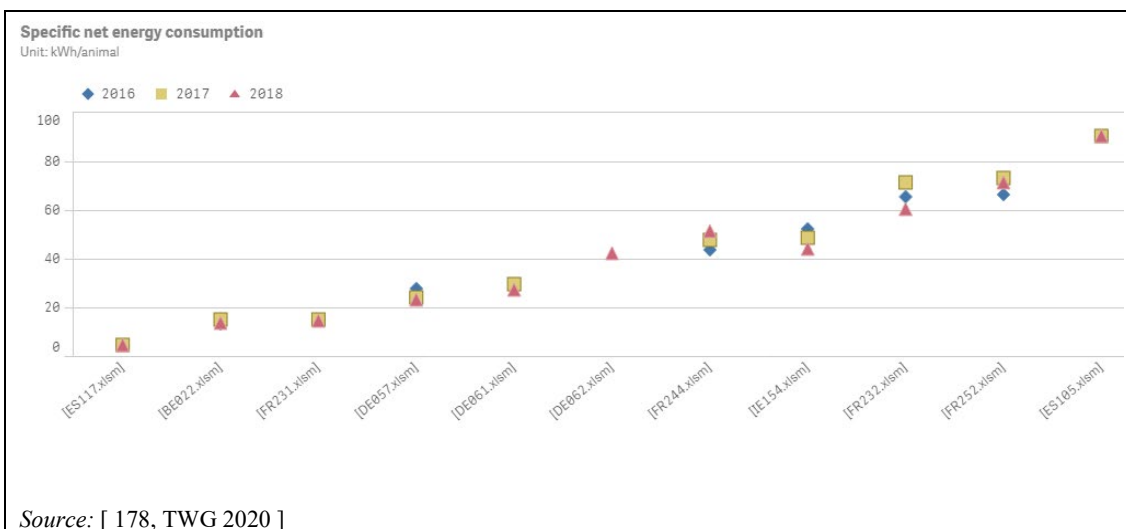

Source: [178, TWG 2020]

Figure 3.22: Specific net energy consumption (kWh/animal) in cattle slaughterhouses for cooling systems

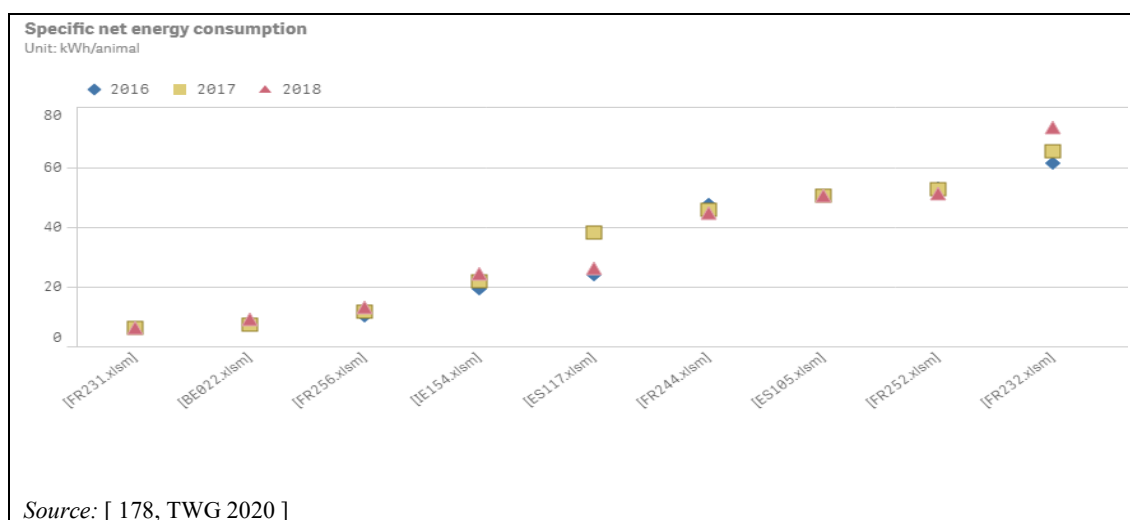

Figure 3.23: Specific net energy consumption (kWh/animal) for production of hot water for cleaning and disinfection in cattle slaughterhouses

3.3.2.2 Water consumption

3.3.2.2.1 Specific net water consumption in m³/tonne of carcass

Figure 3.24 shows data (from installations participating in the data collection, for the years 2016 to 2018) in relation to total specific net water consumption in terms of m³/tonne of carcass at installation level.

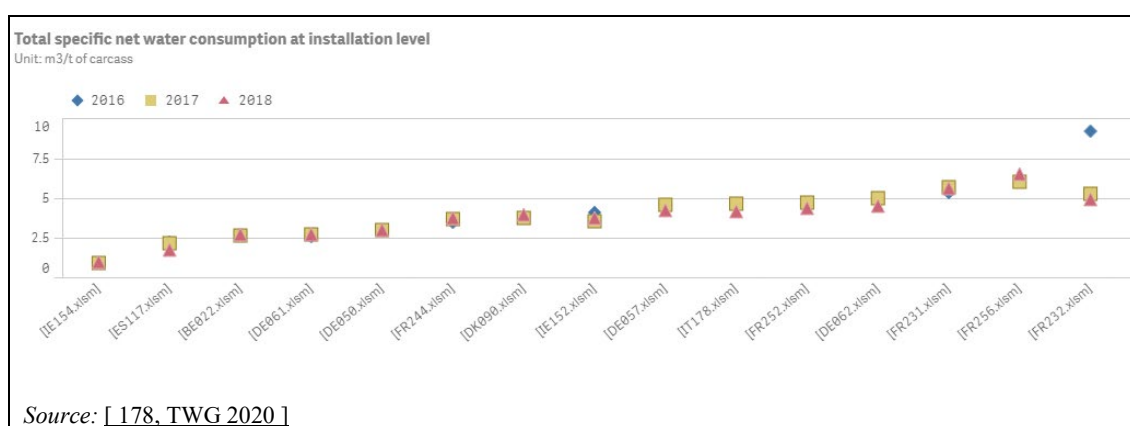

Figure 3.24: Specific net water consumption (m³/tonne of carcass) in cattle slaughterhouses (installation level)

Figure 3.25, Figure 3.26 and Figure 3.27 show the specific net water consumption (from installations participating in the data collection, for the years 2016 to 2018) in m³/tonne of carcass, for several specific processes in cattle slaughterhouses.

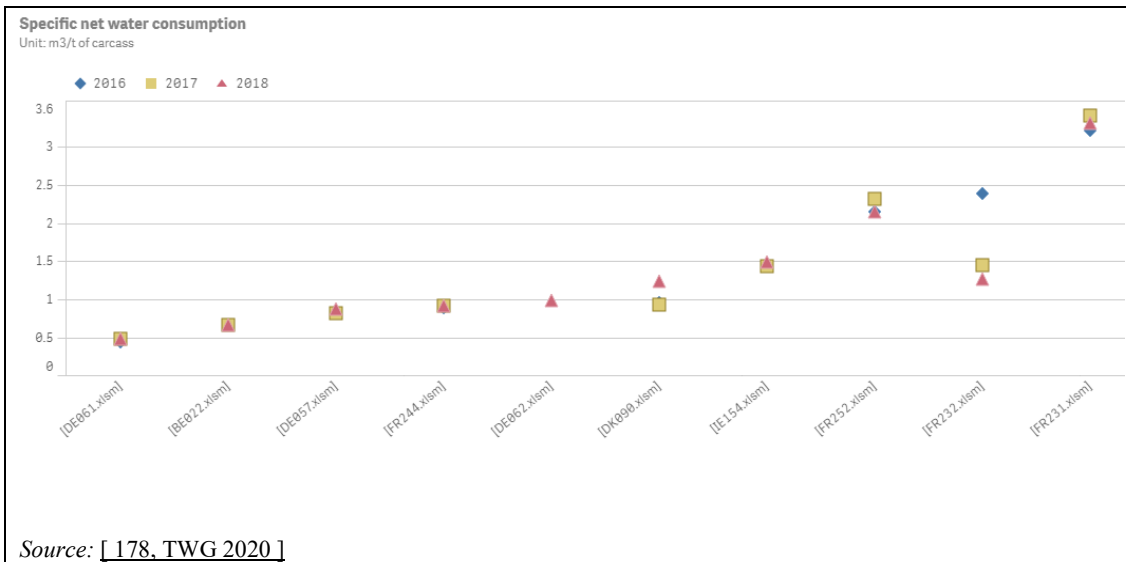

Figure 3.25: Specific net water consumption (m³/tonne of carcass) for cleaning of floors/walls and equipment in cattle slaughterhouses

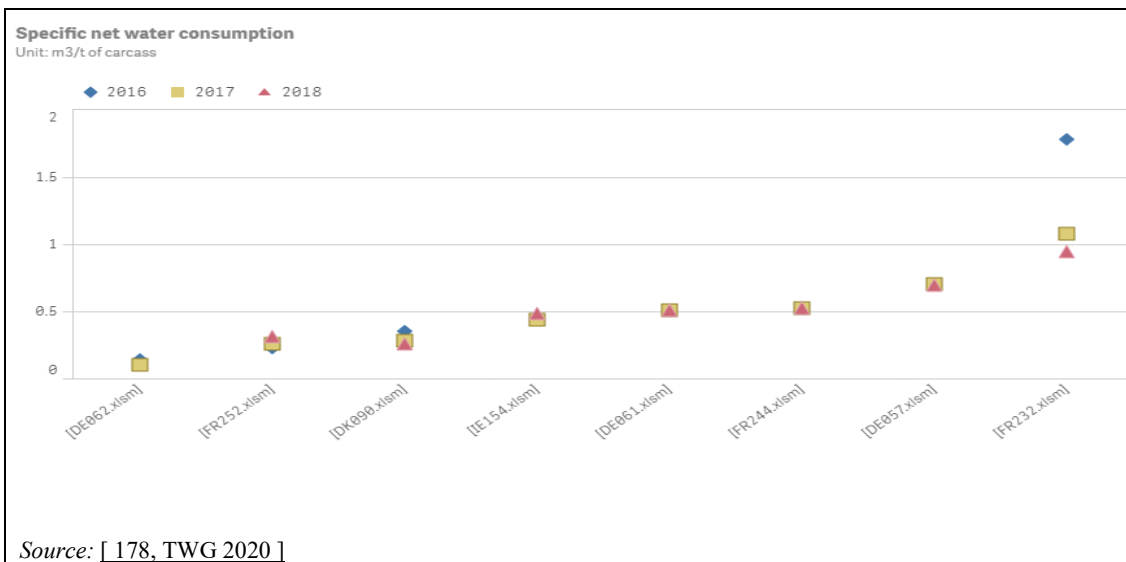

Figure 3.26: Specific net water consumption (m³/tonne of carcass) for handling of casings and offal in cattle slaughterhouses

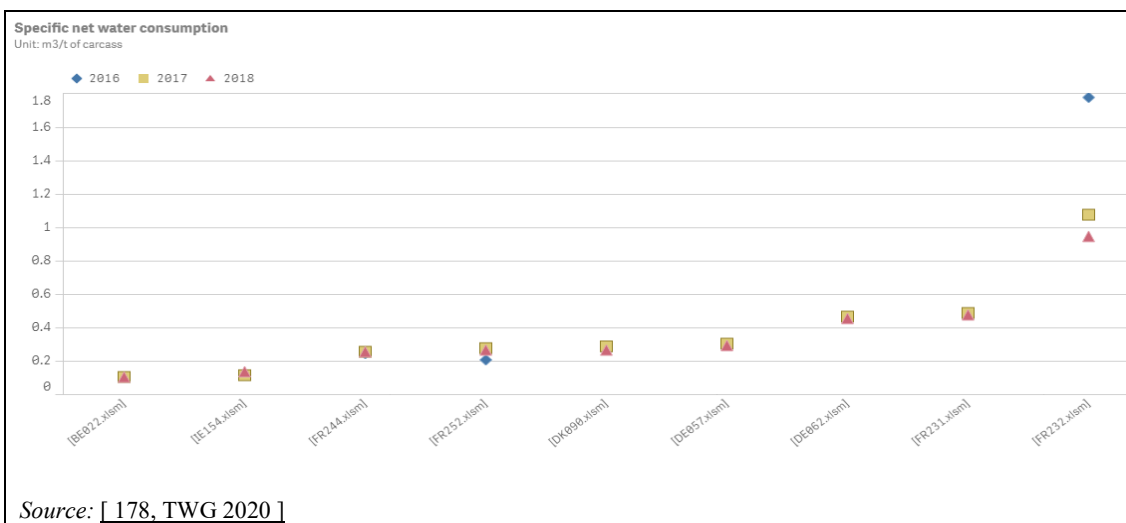

Figure 3.27: Specific net water consumption (m³/tonne of carcass) for vehicle washing in cattle slaughterhouses

3.3.2.2.2 Specific net water consumption in m³/animal

Figure 3.28 shows data (from installations participating in the data collection, for the years 2016 to 2018) in relation to total specific net water consumption in terms of m³/animal at installation level.

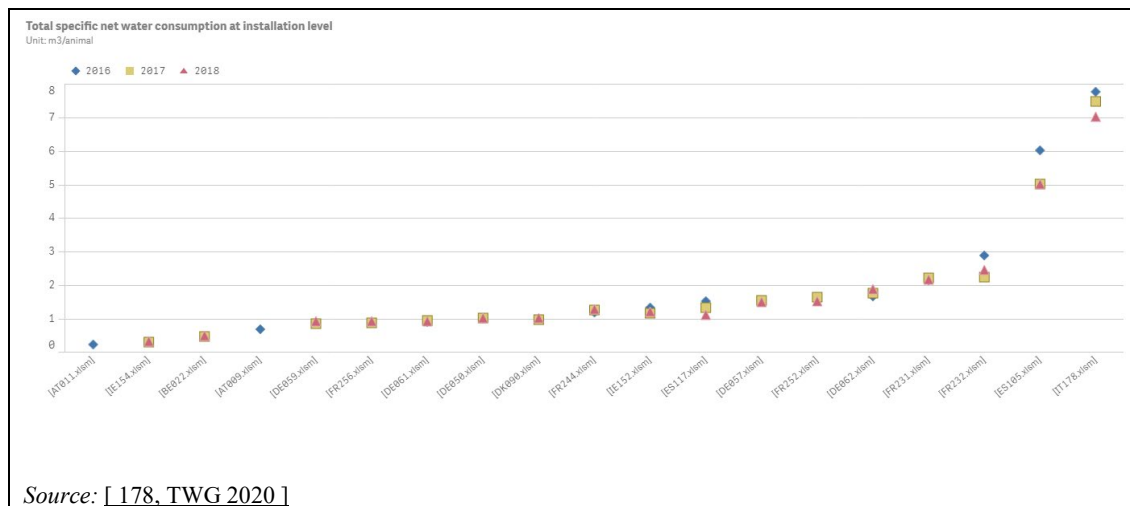

Figure 3.28: Specific net water consumption (m³/animal) in cattle slaughterhouses (installation level)

Figure 3.29, Figure 3.30 and Figure 3.31 show the specific net water consumption (from installations participating in the data collection, for the years 2016 to 2018) in m³/animal, for several specific processes in cattle slaughterhouses.

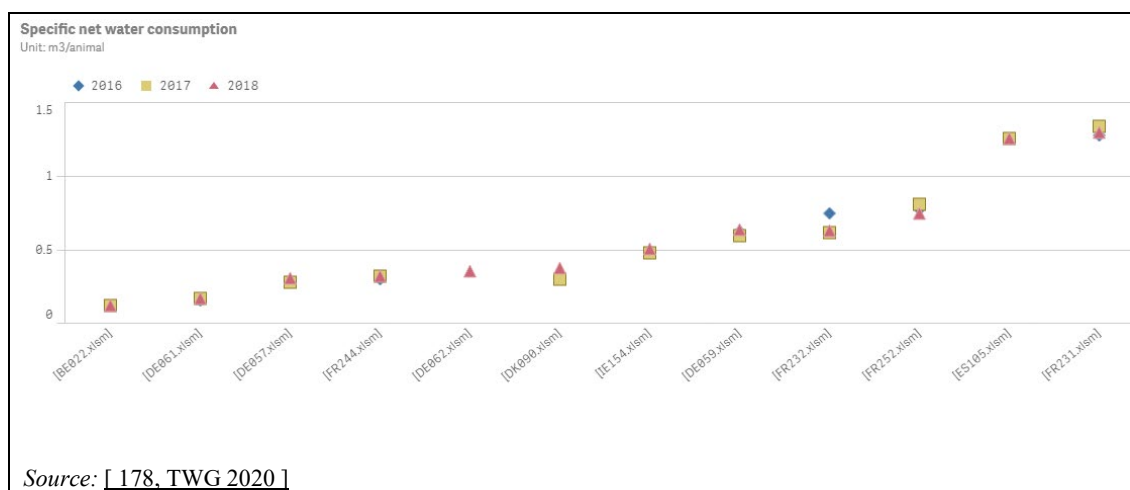

Figure 3.29: Specific net water consumption (m³/animal) for cleaning of floors/walls and equipment in cattle slaughterhouses

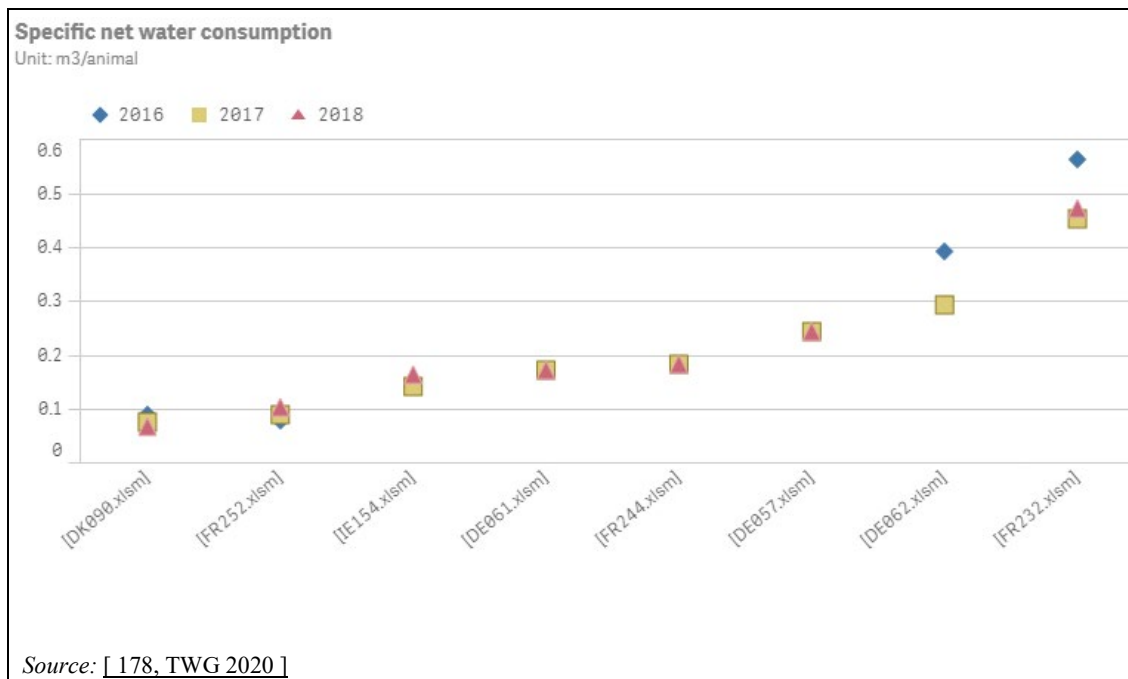

Figure 3.30: Specific net water consumption (m³/animal) for handling of casings and offal in cattle slaughterhouses

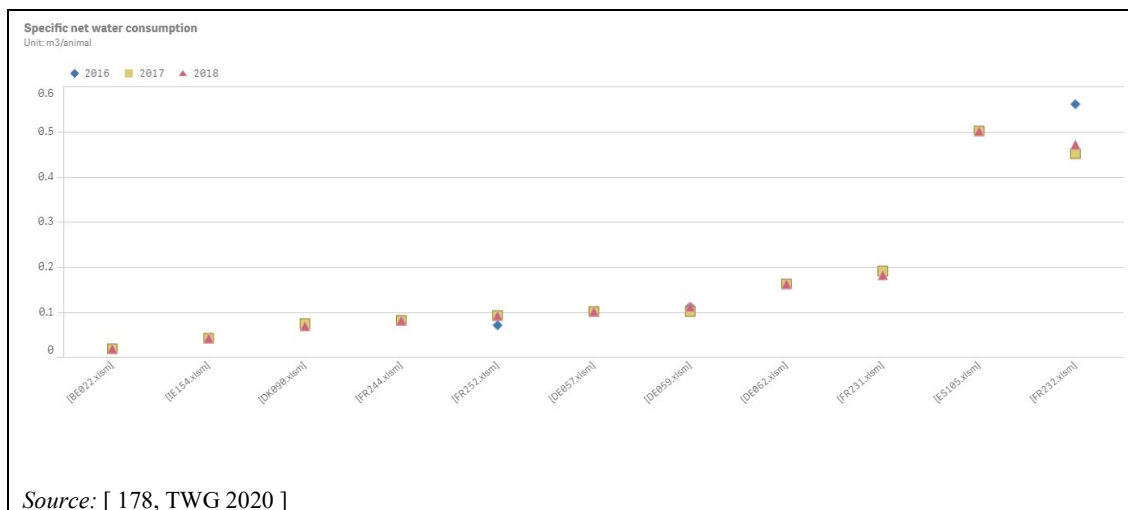

Figure 3.31: Specific net water consumption (m³/animal) for vehicle washing in cattle slaughterhouses

3.3.2.2.3 Emissions to water

Figure 3.32 shows reported data (from installations participating in the data collection, for the years 2016 to 2018) on specific waste water discharge in m³/tonne of carcass from cattle slaughterhouses and all types of discharges, as well as the reported techniques to reduce water consumption.



Figure 3.32: Specific waste water discharge (m³/tonne of carcass) in cattle slaughterhouses for all types of discharges and applied techniques to reduce water consumption

Figure 3.33 shows reported data (from installations participating in the data collection, for the years 2016 to 2018) on specific waste water discharge in m³/animal from cattle slaughterhouses and all types of discharges, as well as the reported techniques to reduce water consumption

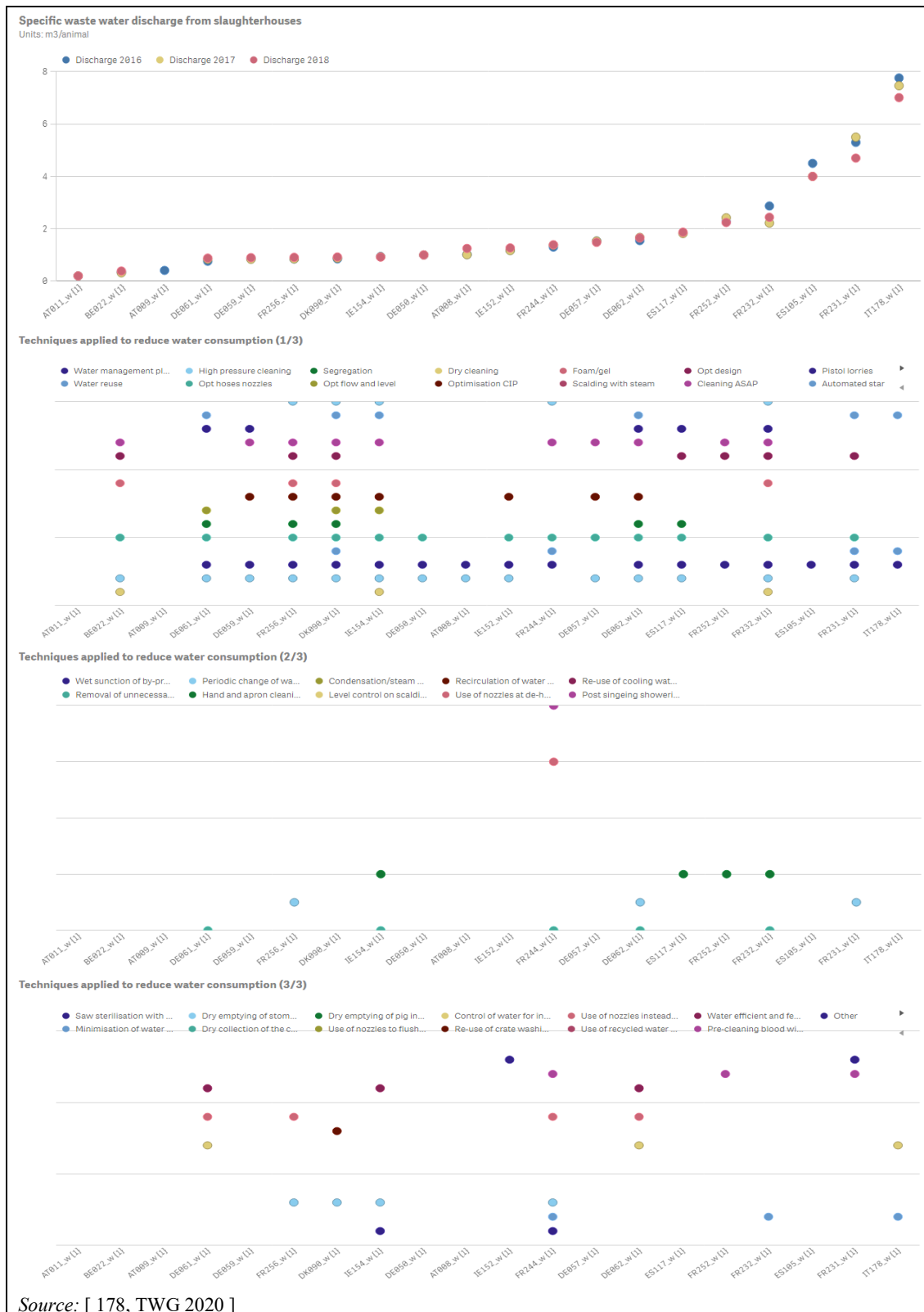

Figure 3.33: Specific waste water discharge (m³/animal) in cattle slaughterhouses for all types of discharges and reported techniques to reduce water consumption

Head and hoof removal for cattle

Significant blood spillage occurs from the large blood vessels when the head is cut off. Rinsing the heads to remove blood can, as well as increasing water consumption and water contamination, spread impurities to other areas of the carcass. The need to rinse can therefore be limited by using correct slaughter procedures.

3.3.2.3 Pig slaughterhouses

This section presents data for installations exclusively slaughtering pigs.

3.3.2.3.1 Energy consumption

In many slaughterhouses there are opportunities to recover useable heat from the exhaust emission and opportunities to minimise heat losses during scalding. The condensation that occurs following evaporation can be removed by extraction.

3.3.2.3.1.1 Specific net energy consumption in kWh/tonne of carcass

Figure 3.34 shows data (from installations participating in the data collection, for the years 2016 to 2018) in relation to total specific net energy consumption in kWh/tonne of carcass at installation level, as well as the applied techniques to reduce energy consumption.

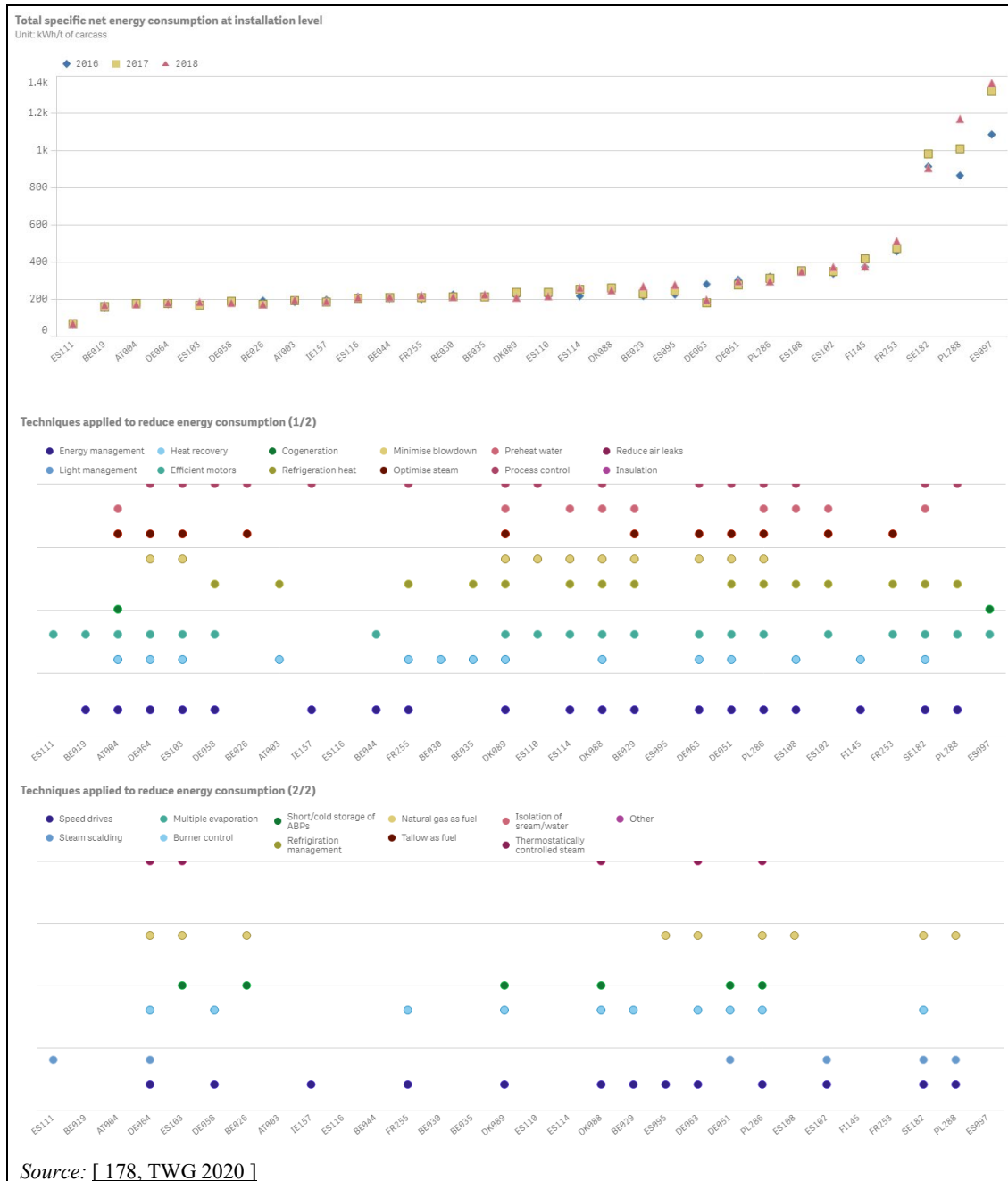

Figure 3.34: Specific net energy consumption (kWh/tonne of carcass) and applied techniques to reduce energy consumption in pig slaughterhouses (installation level)

Figure 3.35 shows data (from installations participating in the data collection, for the years 2016 to 2018) in relation to total specific net electricity and heat consumption in kWh/tonne of carcass at installation level.

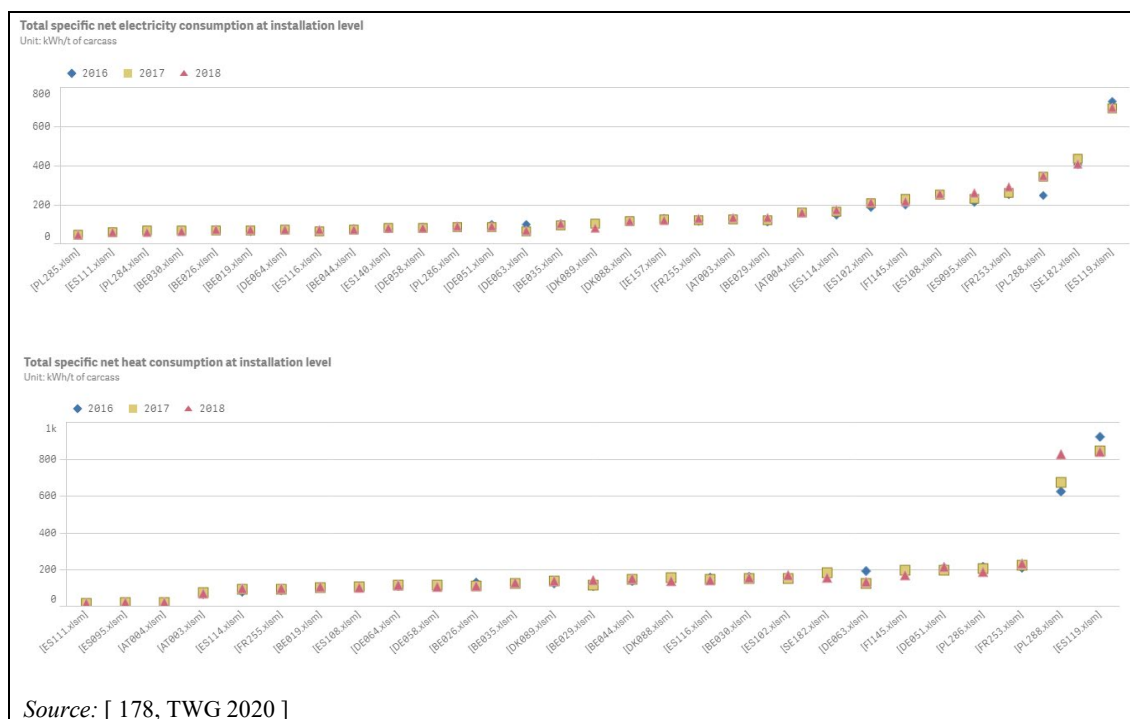

Figure 3.35: Specific net electricity and heat consumption (kWh/tonne of carcass) in pig slaughterhouses (installation level)

Figure 3.36, Figure 3.37, Figure 3.38 and Figure 3.39 show the specific net energy consumption (from installations participating in the data collection, for the years 2016 to 2018) in kWh/tonne of carcass, in various pig slaughterhouse processes.

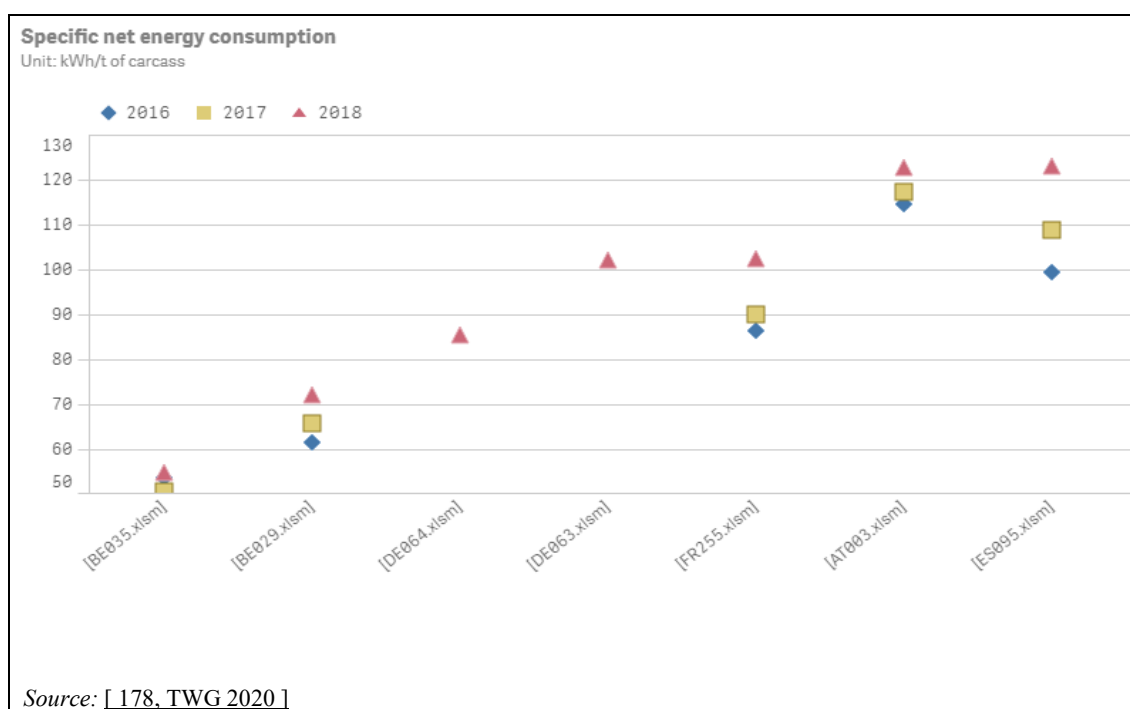

Figure 3.36: Specific net energy consumption (kWh/tonne of carcass) for cooling systems in pig slaughterhouses

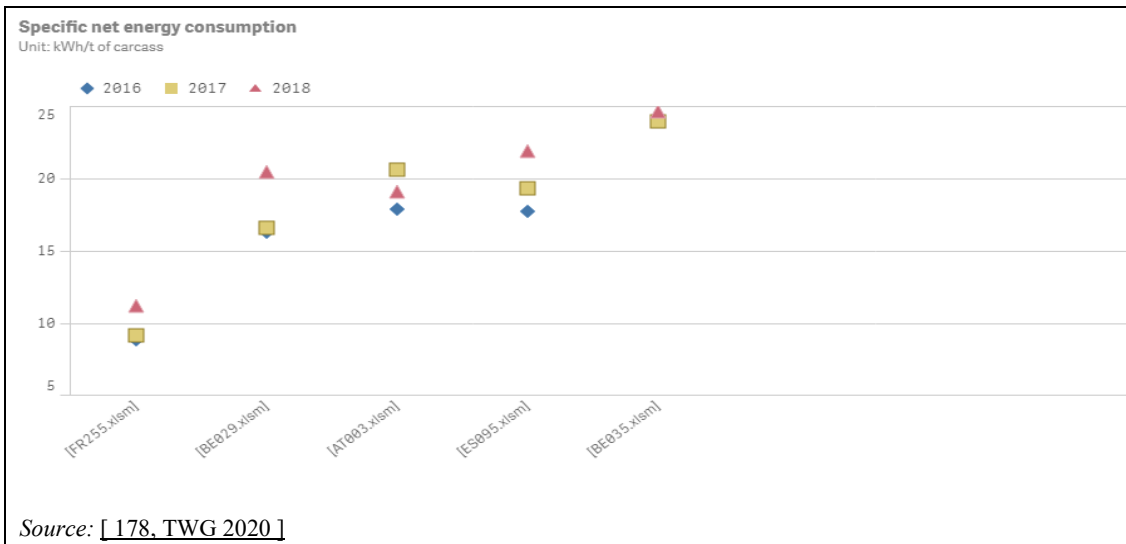

Figure 3.37: Specific net energy consumption (kWh/tonne of carcass) for production of hot water for cleaning and disinfection in pig slaughterhouses

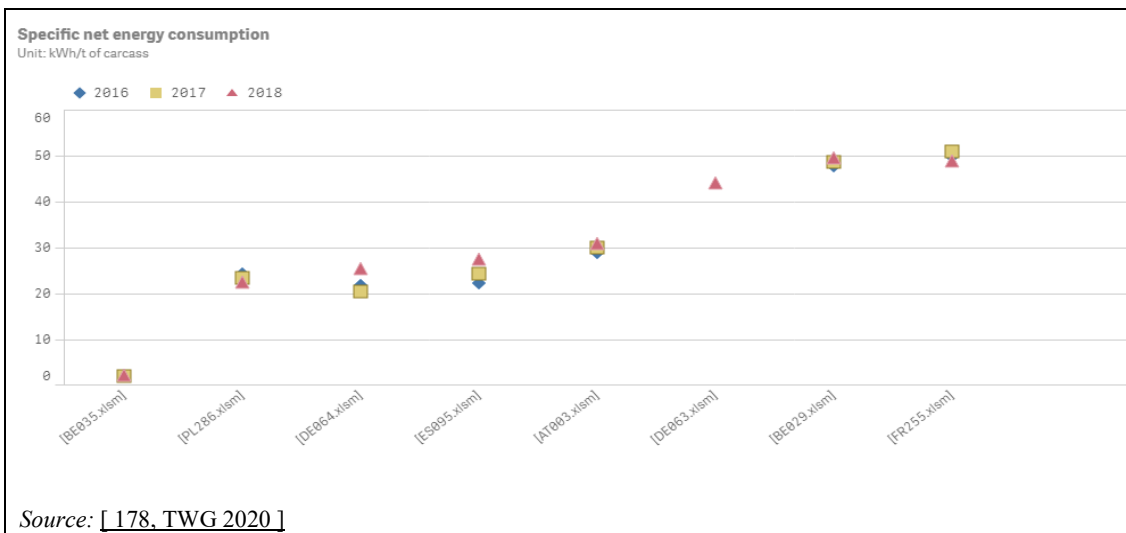

Figure 3.38: Specific net energy consumption (kWh/tonne of carcass) for pig singeing in pig slaughterhouses

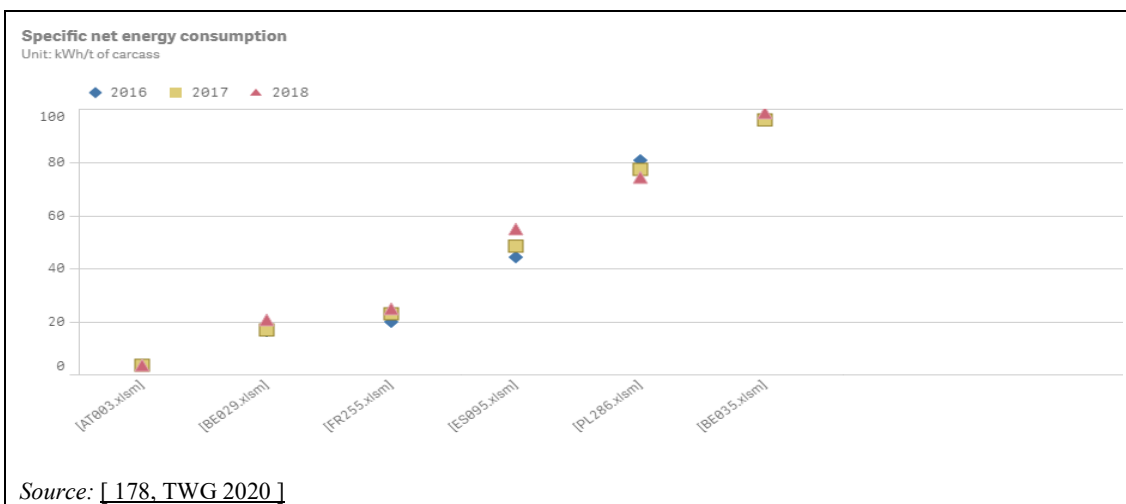

Figure 3.39: Specific net energy consumption (kWh/tonne of carcass) for scalding in pig slaughterhouses

3.3.2.3.1.2 Specific net energy consumption in kWh/animal

Figure 3.40 shows data (from installations participating in the data collection, for the years 2016 to 2018) in relation to total specific net energy consumption in kWh/animal at installation level, as well as the applied techniques to reduce energy consumption.

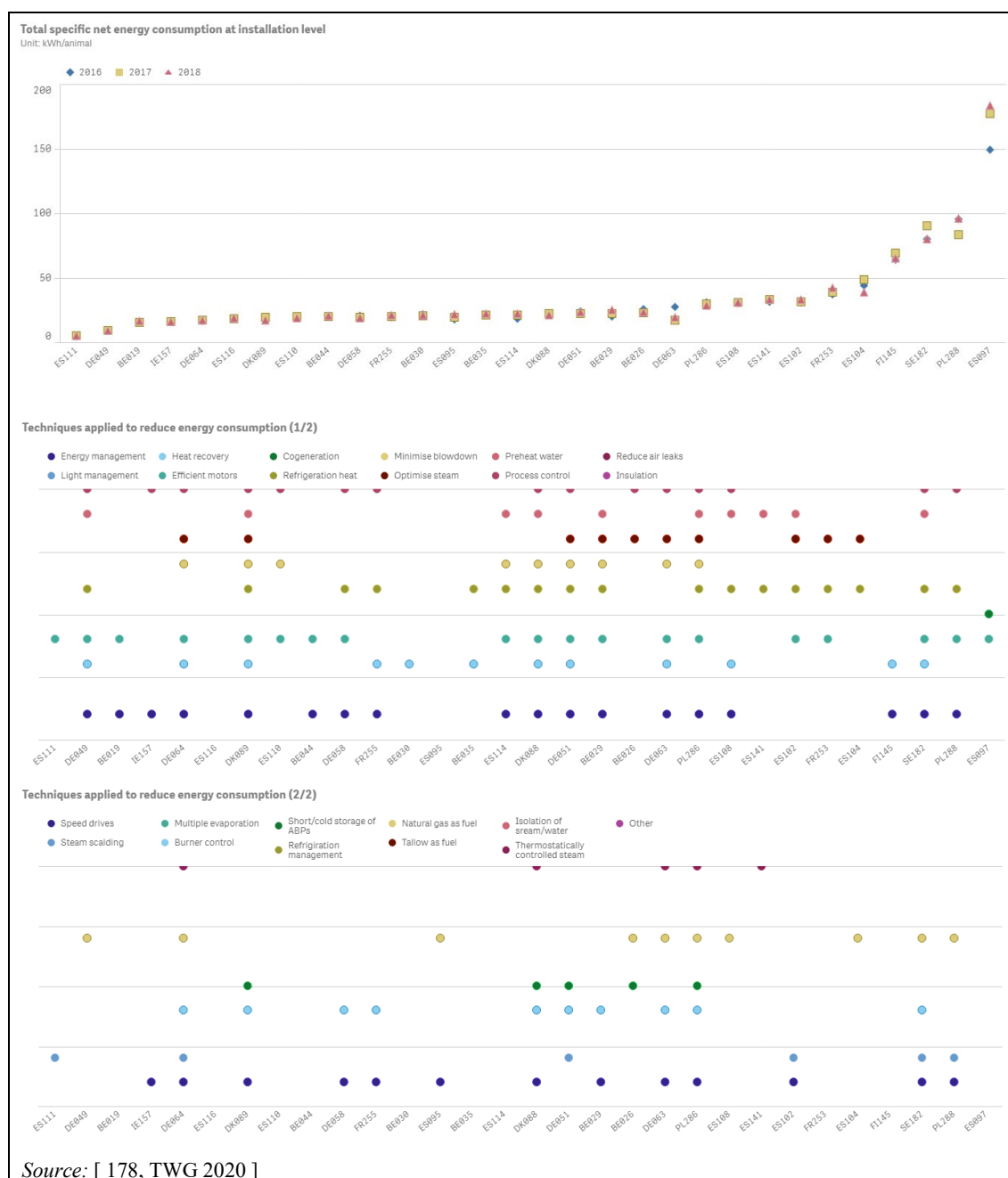

Figure 3.40: Specific net energy consumption (kWh/animal) and applied techniques to reduce energy consumption in pig slaughterhouses (installation level)

Figure 3.41 shows data (from installations participating in the data collection, for the years 2016 to 2018) in relation to total specific net electricity and heat consumption in kWh/animal at installation level.

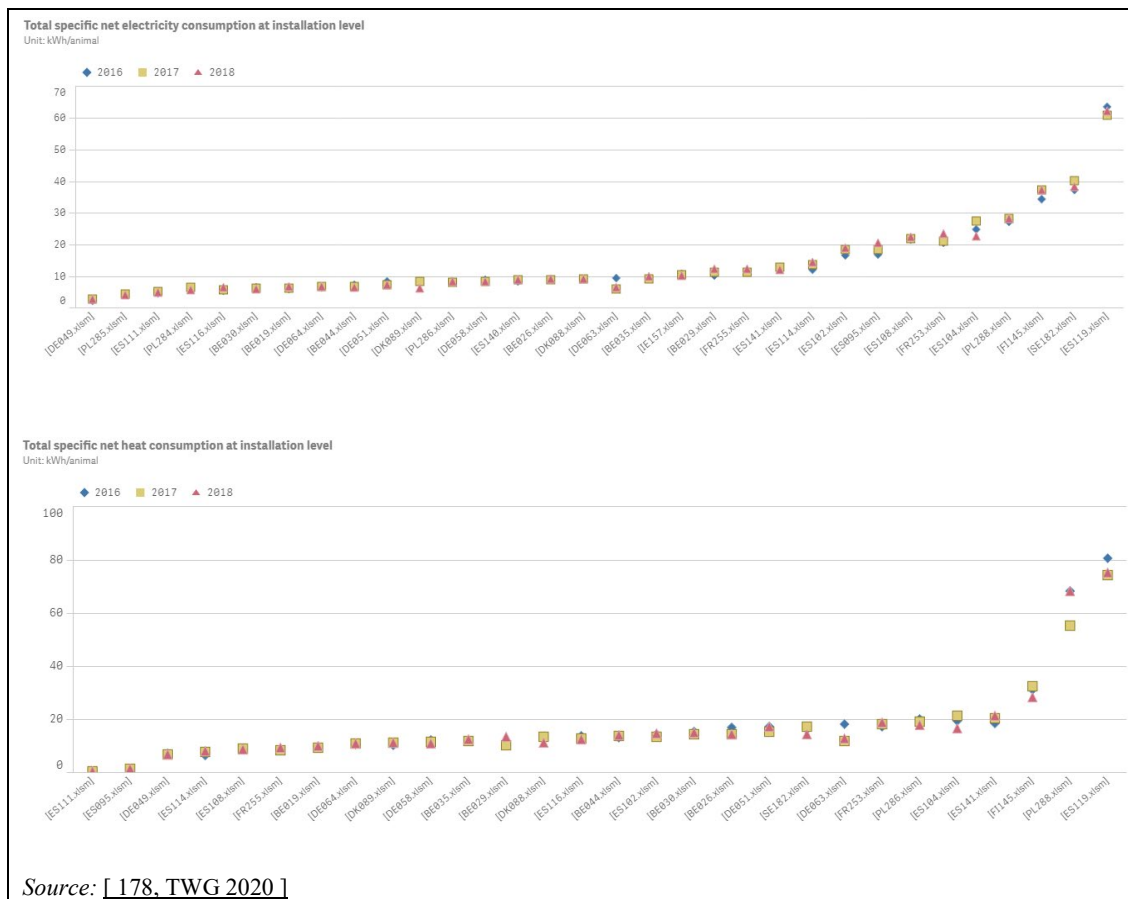

Figure 3.41: Specific net electricity and heat consumption (kWh/animal) in pig slaughterhouses (installation level)

Figure 3.42, Figure 3.43, Figure 3.44 and Figure 3.45 show the specific net energy consumption (from installations participating in the data collection, for the years 2016 to 2018) in kWh/animal, in various pig slaughterhouse processes.

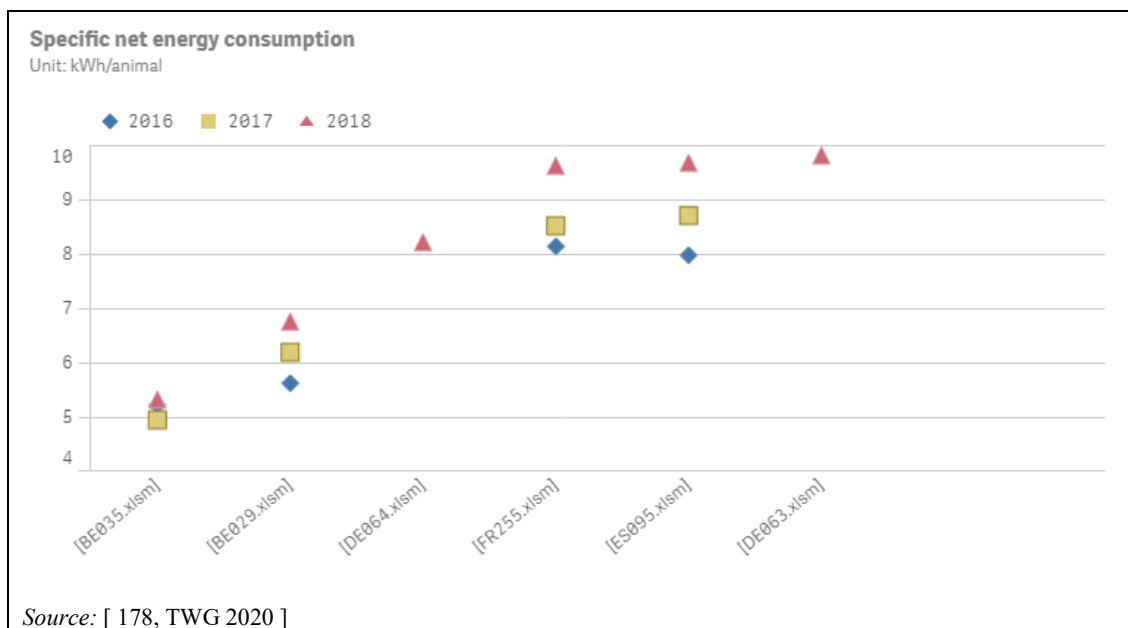

Figure 3.42: Specific net energy consumption (kWh/animal) for cooling systems in pig slaughterhouses

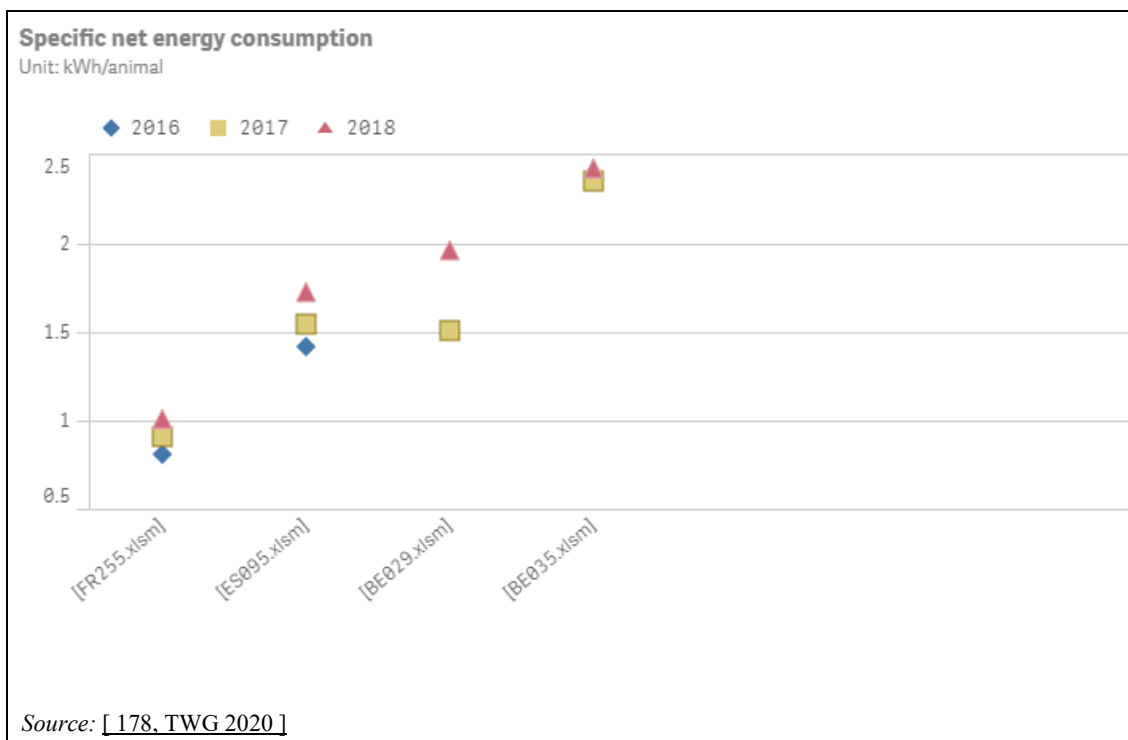

Figure 3.43: Specific net energy consumption (kWh/animal) for production of hot water for cleaning and disinfection in pig slaughterhouses

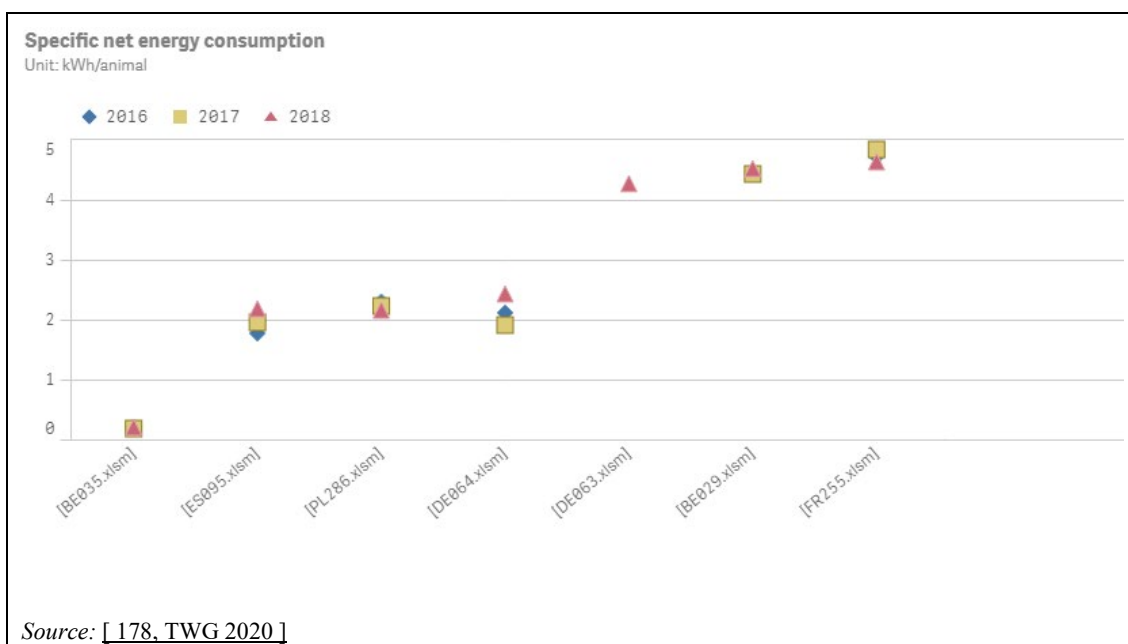

Figure 3.44: Specific net energy consumption (kWh/animal) for pig singeing in pig slaughterhouses

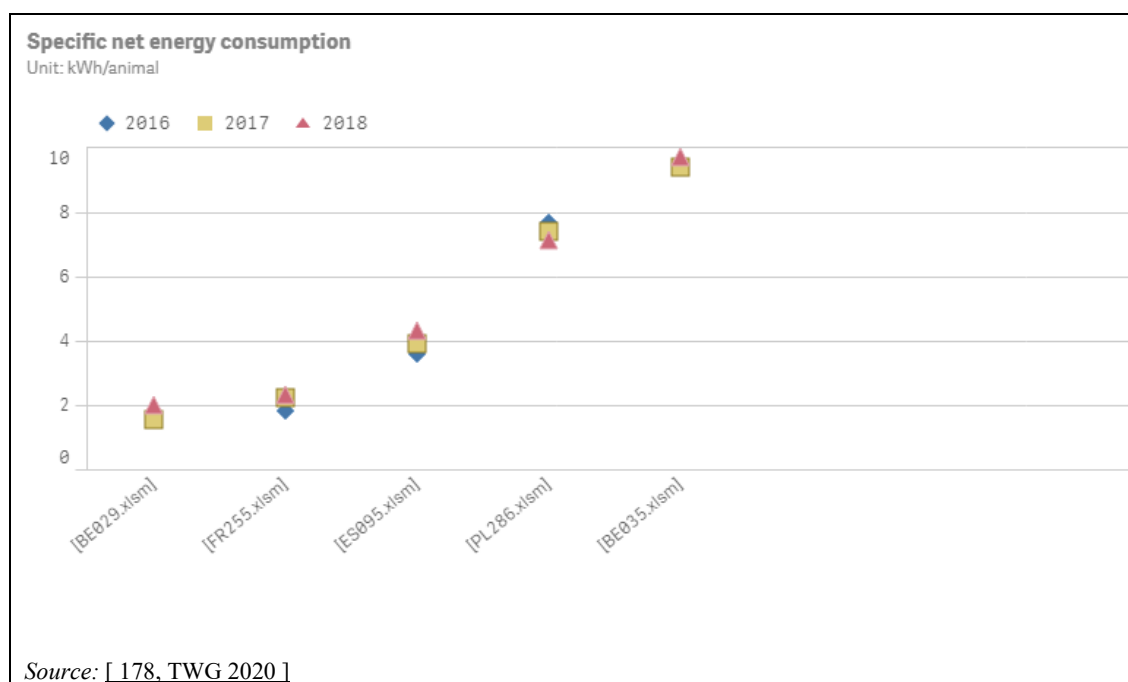

Figure 3.45: Specific net energy consumption (kWh/animal) for scalding in pig slaughterhouses

3.3.2.3.2 Water consumption

Pig scalding

The scalding tanks are filled with water at the beginning of each day. They are kept at a temperature of approximately 60 °C throughout the day. Debris and sludge build up in the tanks during production. It is common practice in many slaughterhouses to empty the water and sludge directly into the site waste water drainage system at the end of each day. In some cases, the tank is refilled by leaving the water supply running until it is switched off by the cleaning staff, or the water is even left to run overnight, allowing excess water to spill over the tank into the drain. Some slaughterhouses have made considerable savings by installing a simple ball valve or other level-sensing device to switch off the water supply when the scalding tank is full [4, WS Atkins-EA 2000].

Hide and skin removal

The practice of de-hiding pigs is relatively rare, but, where it is carried out, the pigs are machine-washed and dried before the hides are removed. Limited figures for the de-hiding of pigs report that water is used at a rate of approximately 70 l/pig, for de-hiding. This includes thorough cleaning of the pigs in the lairage and after bleeding, to avoid contamination during the de-hiding process [77, Pontoppidan O. 2002].

Dehairing

Use of appropriate amounts of water in the de-hairer improves product hygiene. It is assessed that the optimal water consumption can vary between 10 litres and 20 litres per carcass. Product hygiene has an impact on the ability of the meat products to remain fresh and thus the distance to which they can be exported as fresh meat [118, Denmark 2015], [204, TWG 2021].

3.3.2.3.2.1 Specific net water consumption in m³/tonne of carcass

Figure 3.46 shows data (from installations participating in the data collection, for the years 2016 to 2018) in relation to total specific net water consumption in terms of m³/tonne of carcass at installation level.

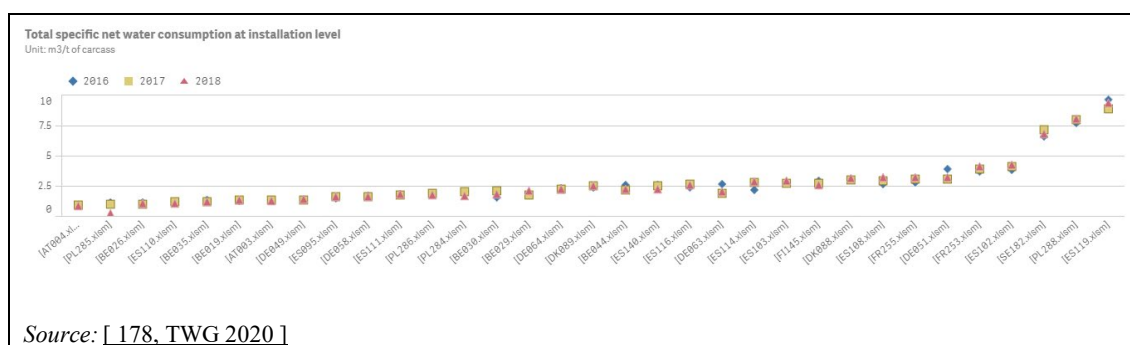

Figure 3.46: Specific net water consumption (m³/tonne of carcass) in pig slaughterhouses (installation level)

Figure 3.47, Figure 3.48, Figure 3.49 and Figure 3.50 show the specific net water consumption (from installations participating in the data collection, for the years 2016 to 2018) in m³/tonne of carcass, for several specific processes in pig slaughterhouses.

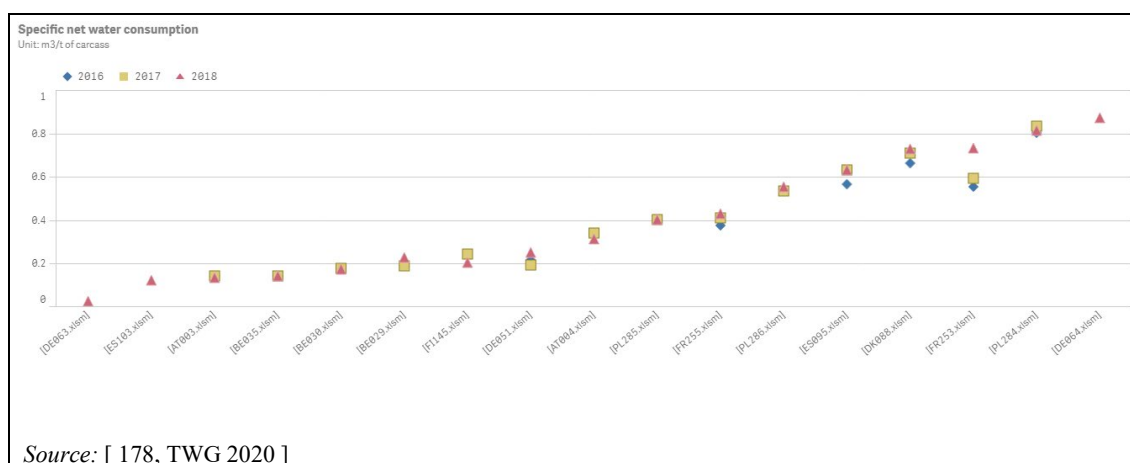

Figure 3.47: Specific net water consumption (m³/tonne of carcass) for cleaning of floors/walls and equipment in pig slaughterhouses

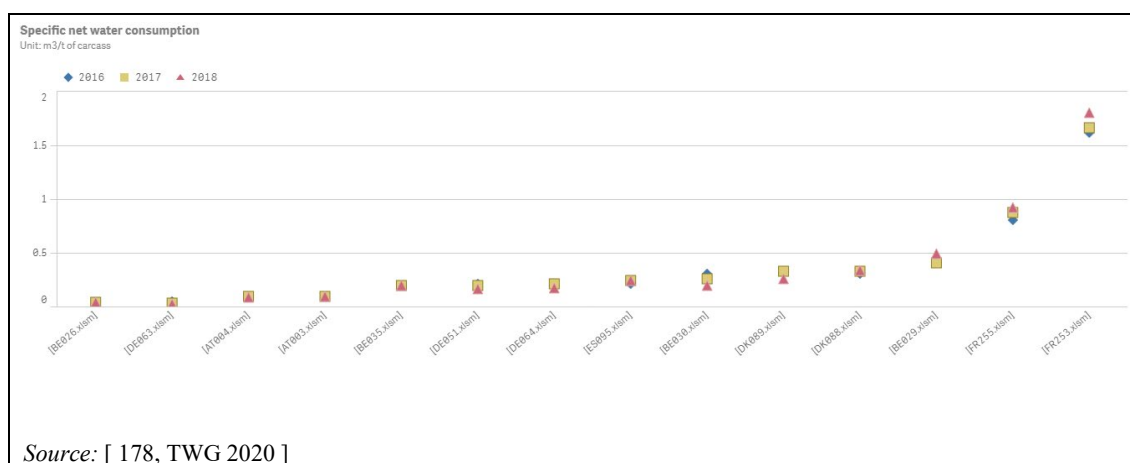

Figure 3.48: Specific net water consumption (m³/tonne of carcass) for handling of casings and offal in pig slaughterhouses

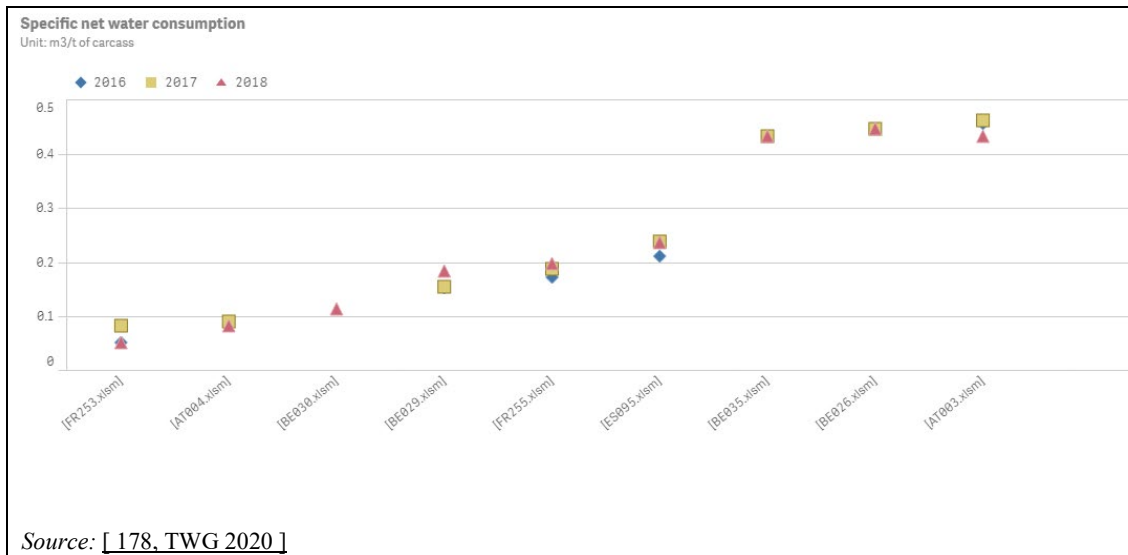

Figure 3.49: Specific net water consumption (m³/tonne of carcass) for scalding in pig slaughterhouses

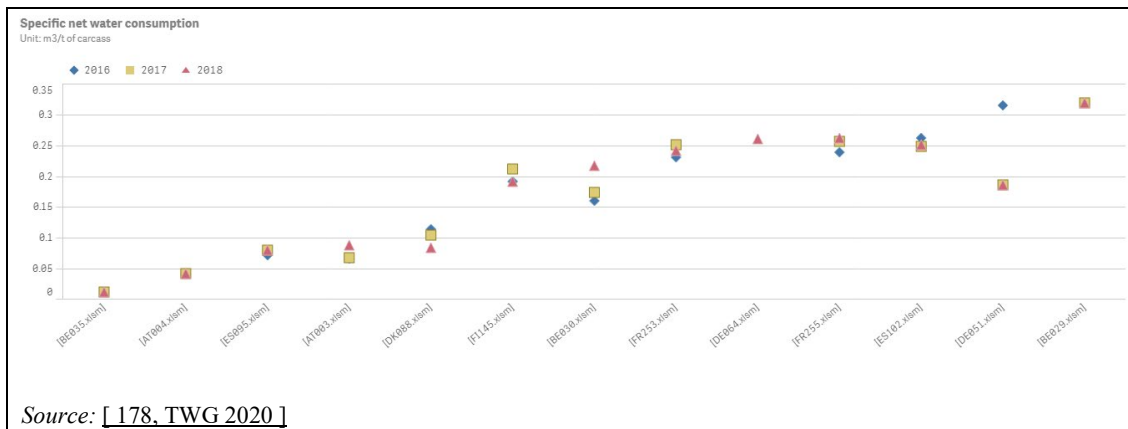

Figure 3.50: Specific net water consumption (m³/tonne of carcass) for vehicle washing in pig slaughterhouses

3.3.2.3.2.2 Specific net water consumption in m³/animal

Figure 3.51 shows data (from installations participating in the data collection, for the years 2016 to 2018) in relation to total specific net energy consumption in terms of m³/animal at installation level.

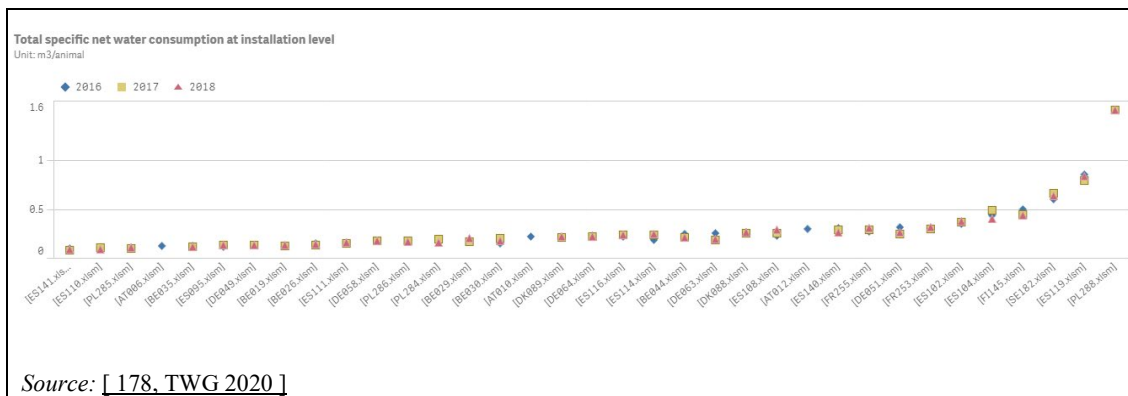

Figure 3.51: Specific net water consumption (m³/animal) in pig slaughterhouses (installation level)

Figure 3.52, Figure 3.53, Figure 3.54 and Figure 3.55 show the specific net water consumption (from installations participating in the data collection, for the years 2016 to 2018) in m³/animal, for several specific processes in pig slaughterhouses.

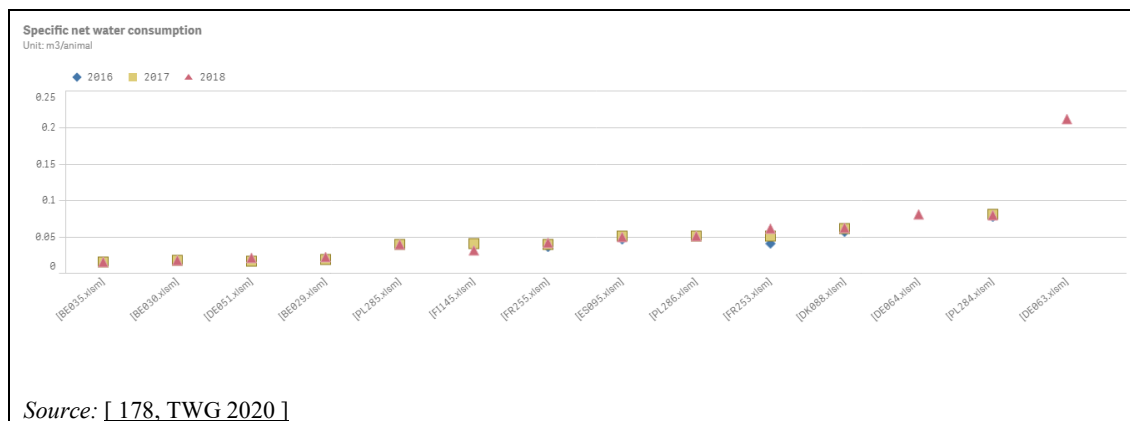

Figure 3.52: Specific net water consumption (m³/animal) for cleaning of floors/walls and equipment in pig slaughterhouses

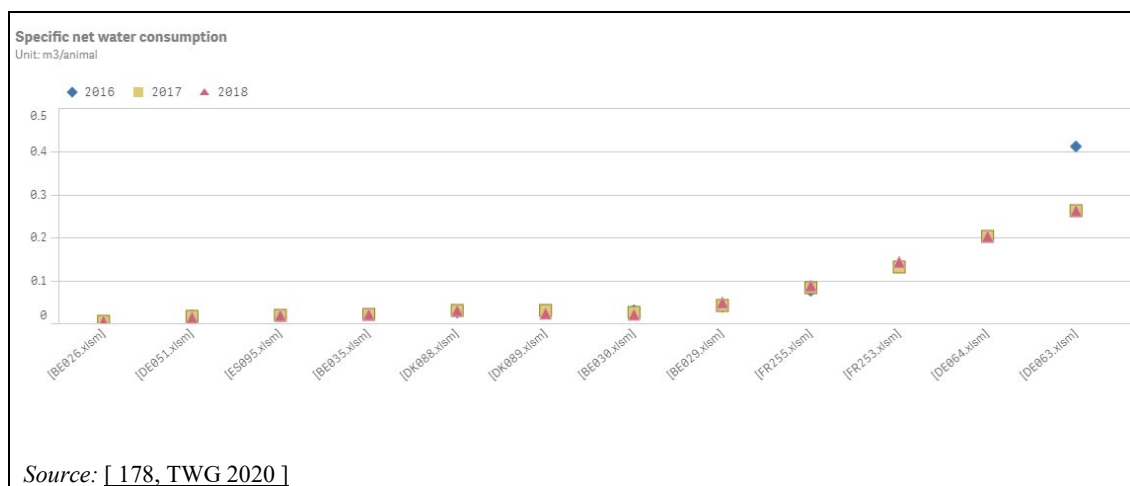

Figure 3.53: Specific net water consumption (m³/animal) for handling of casings and offal in pig slaughterhouses

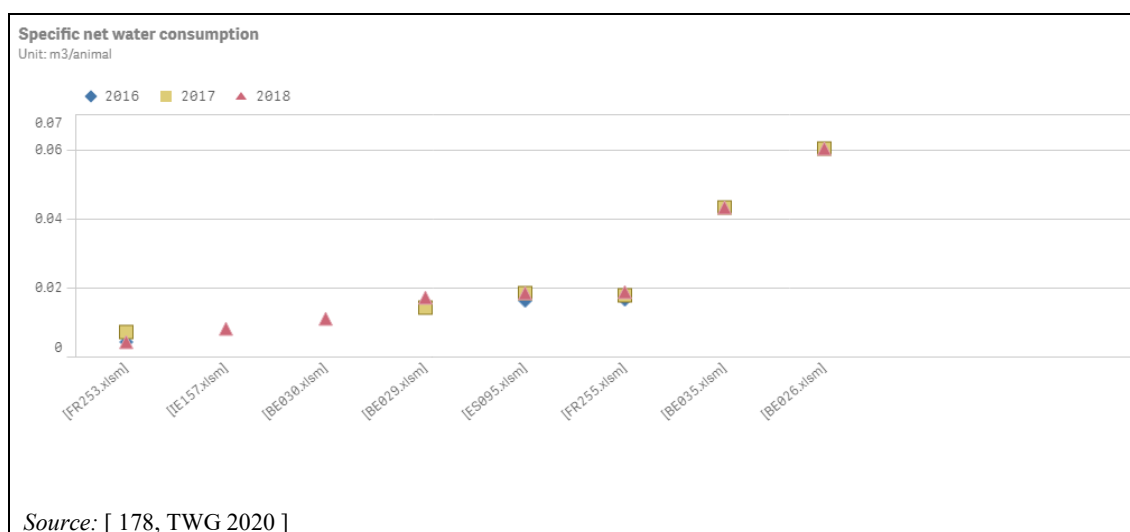

Figure 3.54: Specific net water consumption (m³/animal) for scalding in pig slaughterhouses

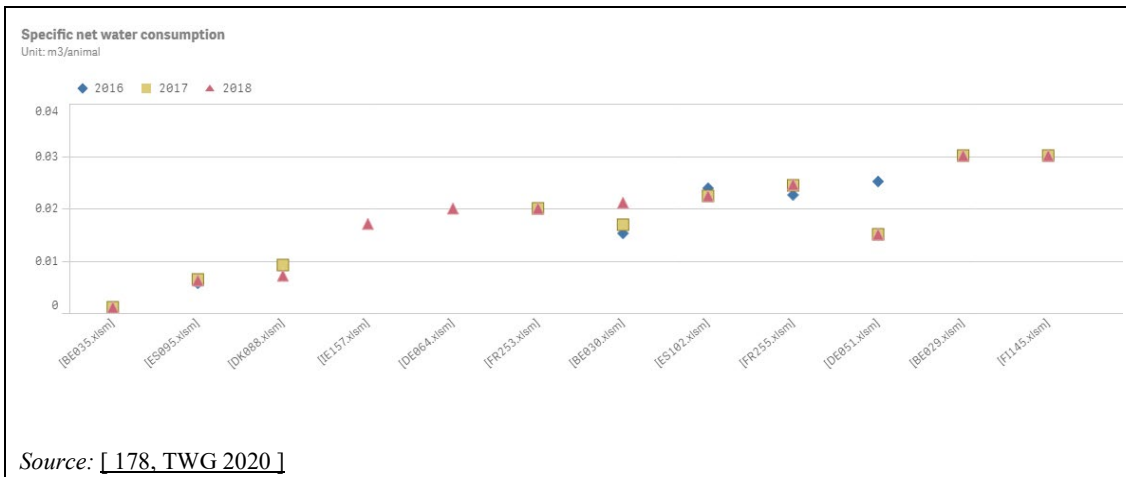

Figure 3.55: Specific net water consumption (m³/animal) for vehicle washing in pig slaughterhouses

3.3.2.3.3 Emissions to water

Figure 3.56 shows reported data (from installations participating in the data collection, for the years 2016 to 2018) on specific waste water discharges per emission point (in m³/tonne of carcass), from pig slaughterhouses and all types of discharges, as well as the reported techniques to reduce water consumption.

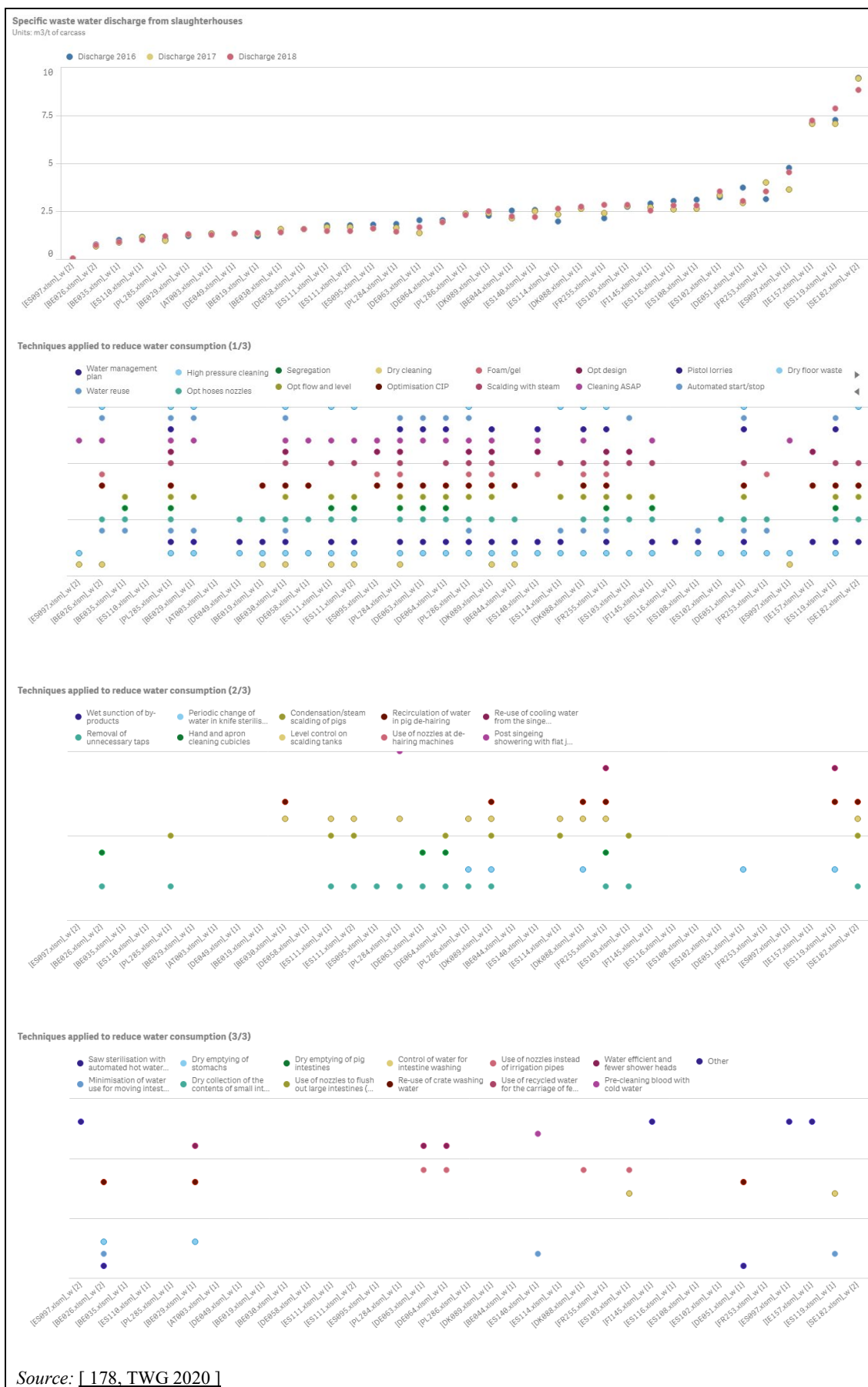

Figure 3.56: Specific waste water discharge per emission point (m³/tonne of carcass) in pig slaughterhouses for all types of discharges and reported techniques to reduce water consumption

Figure 3.57 shows reported data (from installations participating in the data collection, for the years 2016 to 2018) on specific waste water discharges per emission point (in m³/animal), from pig slaughterhouses and all types of discharges, as well as the reported techniques to reduce water consumption.

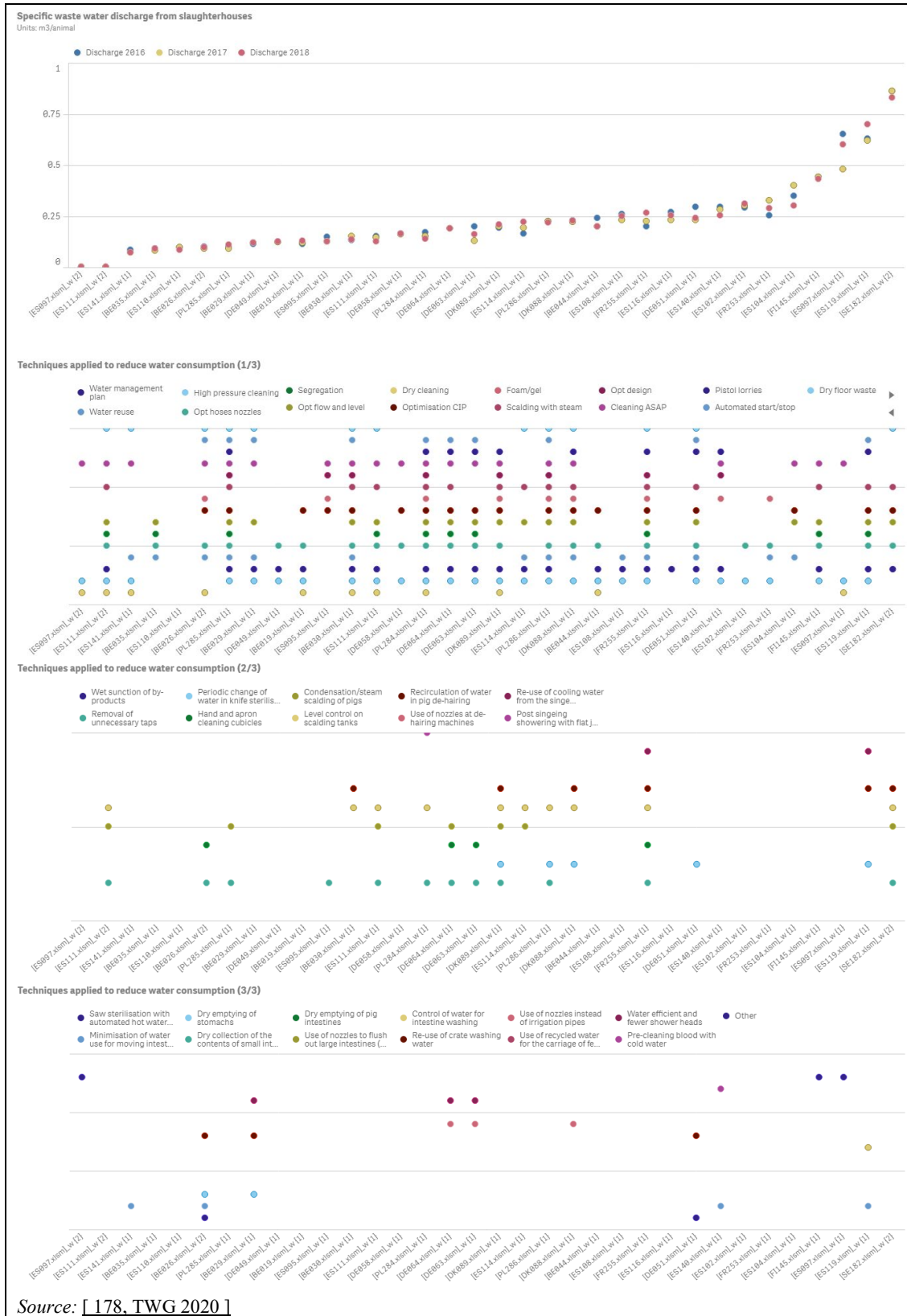

Figure 3.57: Specific waste water discharge per emission point (m³/animal) in pig slaughterhouses for all types of discharges and reported techniques to reduce water consumption

Animal reception and lairage

In Denmark and Sweden, data were collected from some large pig slaughterhouses about the proportion of their water pollution which arises from the lairage/vehicle washing activities. In Denmark, it is estimated that 5 % of the pollution emitted came from these. In Sweden, the proportion was estimated to be 16 % [23, Nordic 2001]. With this information alone, it is not possible to comment on the difference because the overall Swedish figures included 'cutting/deboning' (accounting for 7 %) and those from Denmark did not.

Evisceration

In Denmark and Sweden, data were collected from some large pig slaughterhouses about the proportion of their water pollution which arises from washing casings. In Danish slaughterhouses, it is estimated that 30-50 % of the pollution emitted comes from washing casings. In Sweden, the proportion was estimated to be 10 % [23, Nordic 2001]. Even allowing for the fact that the overall Swedish figures included 'cutting/deboning' (accounting for 7 %) and those from Denmark did not, the difference is significant. The difference is explained by the fact that in Denmark approximately 100 % of stomachs, 100 % of small casings, 100 % of fat ends and 40 % of large casings are cleaned for human consumption. In Sweden, the production is much lower [77, Pontoppidan O. 2002].

Table 3.7 shows that de-sliming intestines makes a significant contribution to the overall pollutant load for waste water.

Table 3.7: Specific waste water amounts and pollutant loads with and without de-sliming of bowels

	Examination days	Specific waste water amount	Specific pollutant loads					
			Settleable solids		BOD ₅		COD	
			(l per animal)	(g DS per animal)	Without sediment (g per animal)	With sediment (g per animal)	without sediment (g per animal)	with sediment (g per animal)
Pigs								
- with intestine desliming	7	100-(250)	1-18	30-80	240-750	260-850	340-(1 080)	-
- without intestine desliming	19	58-254	0.2-1.9	8-65	60-366	70-(430)	80-430	-

NB: Calculated values are shown in brackets, i.e. extrapolated of 60:70 (measured) for 366 to calculate 430 (60/70 = 366/430)
Source: [29, Germany 2001]

Pig hair and toenail removal

At this stage of the process, blood is still dripping from the animal. The de-hairing process is wet, so the waste water COD loading may be raised significantly.

3.3.2.3.4 Emissions to airPig singeing

In most pig slaughterhouses, the emissions from the singeing unit are vented directly to the atmosphere, through a hood just above roof level or through high chimneys. Sometimes, the exhaust may include an extraction fan. This emission is estimated to have a temperature of 600-800 °C. It also contains fine burnt hair dust. Some slaughterhouses recover useable heat from the exhaust emission. Due to the high flue temperatures, the equipment used to recover heat from

singeing units requires storage, pumps and safety devices as well as a heat exchanger [4, WS Atkins-EA 2000], [204, TWG 2021].

If LPG is used to singe carcasses, approximately 19.6 l/t is consumed, for a light singe.

Water is used to cool the overhead rail and conveyor system [23, Nordic 2001].

The exhaust air has an odour of burnt hair [23, Nordic 2001].

3.3.3 Techniques to consider in the determination of BAT for the slaughter of large animals

3.3.3.1 Techniques to reduce waste

3.3.3.1.1 Trimming of all hide/skin material not destined for tanning immediately after removal from the animal

Description

Cutting away from the edges of hides and skins all unwanted material such as legs, tails, face, udders, testicles, etc. to give the raw material a better shape.

Technical description

Trimming consists of cutting away from the edges of hides and skins all unwanted material such as legs, tails, face, udders, testicles, etc. to give the raw material a better shape.

This operation is performed manually, using the appropriate knives, ideally carrying it out as early as possible in the production process of hides and skins, to prevent material which is not intended for tanning from being processed unnecessarily. The operation is usually done in the slaughterhouse, although it is sometimes carried out in tanneries. Special knives can be used, depending on the appropriate standard for each type of hide or skin.

Achieved environmental benefits

The trimming of hides directly after hide removal optimises the alternative uses for trimmings, e.g. in pet food, gelatine or cosmetic production, thereby reducing waste production, both at the slaughterhouse and at the tannery. It also removes contaminants which could otherwise lead to the putrefaction of hides and skins.

It also minimises the consumption of substances used in the preservation processes, at both the slaughterhouse and the tannery. For example, at the slaughterhouse, if salt is used to preserve the hide, the amount used will be less. This also reduces the contamination of waste water by salt.

It is reported that trimming to ISO standards can give a 7-10 % reduction in the amount of waste produced in the leather industry.

There is a reduction in the amount of water and process chemicals used during tanning operations.

Odour problems are reduced due to the removal of putrescible trimmings.

Environmental performance and operational data

It is reported that approximately 120 kg/t of trimmings can be recovered from bovine hides at the slaughterhouse and that this can serve as a valuable raw material for other industries or for the production of biogas. Trimmings can be collected in batches, as appropriate, depending on their intended use. There are published standards for trimming hides and skins. Each batch can be monitored and records can be kept. If suppliers and buyers discuss the records regularly, they can plan continuous improvements in the operation of the technique.

It is reported that if fully trimmed hides and skins are delivered to the tannery, total water consumption there can be reduced by about 5 %. Total process chemicals are about 500 kg/t of hides or skins. The reduction in the consumption of substances used in tanning is directly proportional to the weight of the trimmed material. The contamination of waste water is also subsequently reduced.

The technique does not require any special equipment.

It is important that during hide or skin removal and trimming, damage is not caused which will lead to waste aggravated by the mechanical process during tanning.

If the animals are not washed and/or clipped before slaughter the trimming process may expose the operator to a risk of infection from *Escherichia coli* 0157 for example.

Cross-media effects

Additional waste may be produced at the slaughterhouse compared to the tannery. This may however have the advantage that it is not contaminated with those substances used for preservation or tanning and may consequently have a lower environmental impact.

Technical considerations relevant to applicability

Applicable in all large animal slaughterhouses where hide or skin removal is undertaken.

Economics

It is reported that no capital investment is required and that an average sized slaughterhouse can normally perform the technique without supplementary personnel. Some investment will be required for training.

Driving force for implementation

The commercial driving forces are improved earnings from the sale of better shaped hides and skins and better by-product quality. Customer satisfaction is also improved.

The environmental driving force is the improved waste management. There is a reduced waste of raw materials and consumption of process chemicals and water.

Example plants

No information provided.

Reference literature

[101, COTANCE 2003].

3.3.3.2 Techniques to reduce emissions to water

3.3.3.2.1 Storage of hides and skins at 10-15 °C

Description

Hides and skins are stored at 10-15 °C, if they are processed within 8-12 hours.

Technical description

Hides and skins may be stored in hygienic conditions at 10-15 °C, in the short term, if they are processed within 8-12 hours.

Achieved environmental benefits

Compared to alternative preservation techniques, the use of salt and its subsequent contamination of waste water at the slaughterhouse and the tannery, as well as disposal of salt residues, are avoided. The energy which would be required for refrigeration and/or ice-making is also saved. Although it is not considered within the IED, the environmental impact of long-distance refrigerated transport, possibly with the added weight of ice, can also be avoided.

Environmental performance and operational data

Hides and skins may be cooled by spreading them on a clean marble floor with the flesh side in contact with the cold floor, or by passing them through a tank of cooled water.

The opportunities for using untreated hides and skins stored between 10-15 °C are limited by the possibilities of processing them within 8-12 hours, which depends on the proximity of tanneries and their demand for hides/skins.

It has been reported that the quality and yield from fresh hides/skins are better than those from those that have been salted.

Cross-media effects

It has been reported that more biocides are needed when processing fresh hides and skins. This is because the cooling process takes several hours and bacterial growth may develop in this time.

Technical considerations relevant to applicability

Applicable where hides and skins can be processed within 8-12 hours.

Economics

No information provided.

Driving force for implementation

There are reduced costs associated with the purchase of salt, careful addition of salt, ice-making, refrigeration and transport.

Example plants

No information provided.

Reference literature

[76, Black et al. 2013].

3.3.3.2.2 Drum salting of hides and skins

Description

Hides and skins are taken from the slaughter-line directly to a drum, where clean salt that is free from blood and rust for example is added.

Technical description

Hides and skins can be taken from the slaughter-line directly to a drum, similar to a concrete mixer, where clean salt that is free from blood and rust for example is added.

Achieved environmental benefits

Water cooling is not required. The quantity of salt used is reduced by 30-50 %, compared to a salting table. All of the salt is used, compared to the addition of salt at a salting table, which results in significant spillage, much of which inevitably ends up in the waste water. The hide/skin quality is at least as good as before. The need for energy use to chill the hide room is avoided.

Environmental performance and operational data

Hide/skin salting with this method can be done without water cooling, thereby saving 5 litres per head (278 l/t carcass). There was no residual salt, saving approximately 0.7 kg per head (0.039 t/t carcass). When salting large animal hides, an amount of salt equivalent to about 35 % of their weight is used. For example, for a hide weighing 28.5 kg, use 10 kg of salt. For sheepskins, this ratio depends on whether the animals are sheared before slaughter; if not, then an amount of salt equivalent to about 150 % of the skin weight, i.e. excluding the wool, is required.

Cross-media effects

Salt can reduce the efficiency of the WWTP and, unless there is a naturally saline watercourse for receipt of the treated waste water, the salt content can have adverse effects on plant growth.

Technical considerations relevant to applicability

Drum salting has been implemented at the majority of Norwegian sheep/lamb slaughterhouses. For storage times longer than 8 days, e.g. if hides/skins have to be transported overseas, then salting remains the preferred option, due to the weight of ice and the energy consumption required for ice production and for refrigeration.

Economics

No information provided.

Driving force for implementation

Reduction in the salinity of waste water and associated problems with the efficiency of the WWTP.

Example plants

The majority of Norwegian sheep/lamb slaughterhouses.

Reference literature

[23, Nordic 2001], [51, Metcalf and Eddy 1991], [76, Black et al. 2013].

3.3.3.2.3 Drum salting of skins with added boric acid**Description**

Skins are taken from the slaughter-line directly to a drum, with addition of boric acid.

Technical description

Skins can be taken from the slaughter-line directly to a drum, similar to a concrete mixer, where clean salt that is free from blood and rust for example is added. The addition of boric acid prevents the growth of halophilic bacteria, known as 'red heat'.

Achieved environmental benefits

Water cooling is not required. The quantity of salt used is reduced by 30-50 %, compared to a salting table. All of the salt is used, compared to the addition of salt at a salting table, which results in significant spillage and where much of the salt inevitably ends up in the waste water. The skin quality is at least as good as before. The need for energy use to chill the hide room is avoided.

Environmental performance and operational data

Skin salting with this method can be done without water cooling, thereby saving 5 litres per head (278 l/t carcass). There was no residual salt, saving approximately 0.7 kg per head (0.039 t/t carcass).

Cross-media effects

Salt can reduce the efficiency of the WWTP and, unless there is a naturally saline watercourse for receipt of the treated waste water, the salt content can have adverse effects on plant growth. A small amount of boric acid (1-2 %) may be added to the salt, although it is argued that if preservation is carried out properly the use of biocides should not be required.

Technical considerations relevant to applicability

Drum salting has been implemented at the majority of Norwegian sheep/lamb slaughterhouses. For storage times longer than 8 days, e.g. if hides/skins have to be transported overseas, then salting remains the preferred option, due to the weight of ice and the energy consumption required for ice production and for refrigeration.

It has been reported that some tanneries in the UK have been unable to use boric acid because of limits on the amount they are permitted to discharge.

Economics

No information provided.

Driving force for implementation

Reduction in the salinity of waste water and associated problems with the efficiency of the WWTP.

Example plants

No information provided.

Reference literature

[23, Nordic 2001], [51, Metcalf and Eddy 1991], [76, Black et al. 2013], [101, COTANCE 2003].

3.3.3.2.4 Dry collection of salt residues from hide, skin or fur preservation

Description

Salt residues from hide, skin and fur preservation are reused or, if they are excessively contaminated, they are collected and disposed of dry.

Technical description

Salt residues from hide, skin and fur preservation can be reused or, if they are excessively contaminated, they can be collected and disposed of dry. Excessive contaminated salt is disposed of by waste incineration.

Achieved environmental benefits

The quantity of salt used is reduced, so there is less contamination of the waste water.

Environmental performance and operational data

Techniques for the removal or recovery of salt from waste water in slaughterhouses have not been reported. High salinity can disrupt biological WWTPs and, even after dilution, it may still cause corrosion damage. Prevention of waste water contamination appears therefore to be not only the preferred option, but actually the only option for controlling the salt content of waste water. It has been reported that techniques such as ion exchange and reverse osmosis are not suitable for salt removal from slaughterhouse waste water, both of which would produce concentrated brine. Brine can be naturally dried in hot climates.

If dissolved salt is discharged to watercourses it can have a significant environmental impact, especially for rivers with a low flow rate and during periods of low water levels. The high conductivity has an effect on the flora and fauna.

Dry collection may be achieved in vessels, such as trays and troughs, positioned beneath salting drums and tables, to collect overspill associated with, for example, careless loading or spreading of salt. Floor spillages may have to be swept up, due to the corrosive properties of salt and the problems this may cause for a vacuum system.

Cross-media effects

None.

Technical considerations relevant to applicability

Applicable in all slaughterhouses where hides and/or skins are salted.

Economics

Inexpensive and in any case cheaper than the recovery of a disrupted WWTP. The costs are associated with the labour for handling the salt and payment for its disposal, if it cannot be reused.

Driving force for implementation

Trouble-free waste water treatment.

Example plants

No information provided.

Reference literature

[29, Germany 2001], [76, Black et al. 2013], [80, Palomino S. 2002], [106, Germany 2003].

3.3.3.2.5 Preservation of hides and skins by refrigeration**Description**

Cattle hides are washed and refrigerated.

Technical description

Cattle hides are washed and refrigerated at approximately 2 °C.

Achieved environmental benefits

The use of salt is avoided, so potential problems due to the salt at the slaughterhouse and the tannery are prevented. One problem with salt is that it can reduce the efficiency of the waste water treatment plant and, unless there is a naturally saline watercourse for receipt of the treated waste water, the salt content can have adverse effects on plant growth.

Environmental performance and operational data

Washing can lead to contamination and deterioration of the hides/skins.

Cross-media effects

Energy consumption for refrigeration. Washing hides/skins involves the consumption and contamination of water.

Technical considerations relevant to applicability

If the time between the de-hiding and the processing in the tannery is no more than 5-8 days, after draining the blood, it is possible to cool the hides/skins to a temperature of 2 °C by refrigeration. The cooling chain must not be interrupted during transport and storage. If hides/skins can be delivered to a tannery and processed within 8-12 hours after slaughter then they generally do not require any treatment. They can be preserved satisfactorily by chilling, if they are to be processed within 5-8 days. For longer storage times, e.g. if they have to be transported overseas, then salting remains the preferred option, due to the weight of ice and the energy consumption required for ice production and refrigeration.

Economics

The capital investment required for chilling units and cold stores exceeds that for one of the alternatives, i.e. ice-making machinery.

It is, however, reported that investment in cooling equipment is not prohibitive and that, for example, many hide markets and tanneries have invested in cooling systems with good results on quality and total cost.

Driving force for implementation

Reduction in the salinity of waste water and associated problems with the efficiency of the WWTP.

Example plants

The chilling of cattle hides and sheepskins is undertaken in some slaughterhouses in the UK. Nearly all slaughterhouses in Germany that manufacture leather from cow hides practise preservation by refrigeration. This is because the tanneries are within 300 km of the slaughterhouses, so the costs for refrigerated transport are not excessive.

Reference literature

[62, Germany 2002], [76, Black et al. 2013].

3.3.4 Techniques to consider in the determination of BAT for pig slaughterhouses

3.3.4.1 Techniques to increase energy efficiency

3.3.4.1.1 Steam scalding of pigs

Description

Scalding is performed with the use of steam instead of hot water.

Technical description

Scalding with steam is an alternative to scalding in hot water. This procedure operates using moist air heated to approximately 60-62 °C. The pig carcasses are conveyed through a tunnel. The moist air is extracted in the upper part of the tunnel by ventilators and circulated in exterior channels, where it is moistened and heated by steam. Ventilators then blow the hot moist air back into the lower section of the scalding tunnel. Air deflection plates guide the air over the carcasses, where some of it condenses and produces the scalding effect. For outdoor pigs, the bristles are harder and steam is not a suitable means to loosen the bristles of this type of animal [156, TWG 2019]. The technique is illustrated in Figure 3.58.

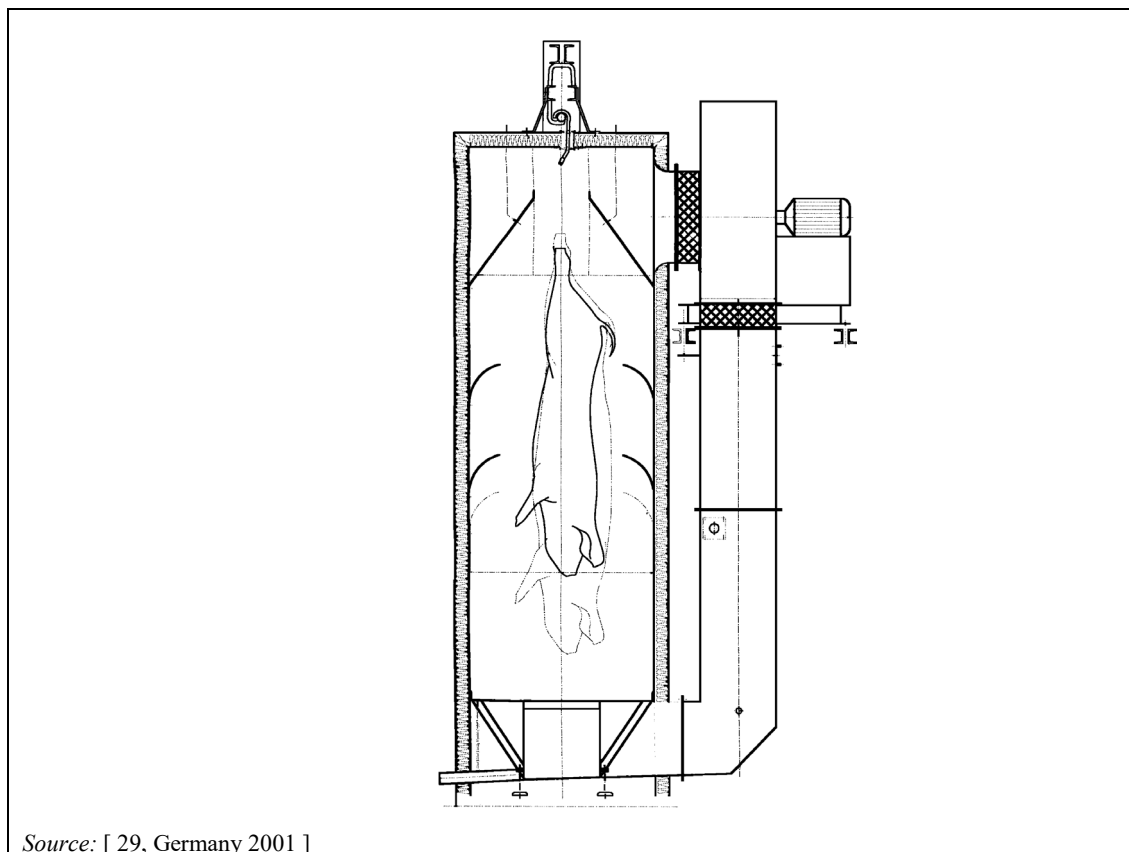

Figure 3.58: Outline of a condensation scalding tunnel

Achieved environmental benefits

Reduced water and energy consumption. The lungs can be used.

Environmental performance and operational data

This process can be maintained at a constant temperature and 100 % humidity under varying loads, which is crucial for a good scalding performance.

The producers' information about consumption values of different scalding methods is listed in Table 3.8.

Table 3.8: Comparison of consumption data of different scalding methods (producers' information)

	Circulation method	Steam scalding method
Energy demand (Revolving pumps/ventilators)	4 x 7.5 kW x 8h/d = 240 kWh/d 240 kWh/d x 200 d/yr = 48 000 kWh/yr	4 x 5.5 kW x 8 h/d = 176 kWh/d 176 kWh/d x 200 d/yr = 35 200 kWh/yr
Heating demand (1 kWh = 3.6 MJ) (fuel oil: 1 kg = 1.2 l)	3 270 kWh/d x 200 d/yr = 654 000 kWh/yr 654 000 kWh/yr x 3.6 MJ/kWh = 2 354 400 MJ/yr 2 354 000 MJ/yr / 40 MJ/kg = 58 860 kg/yr 58 560 kg/yr x 1.2 l/kg = 70 632 l/yr fuel oil	2 020 kWh/d x 200 d/yr = 404 000 kWh/yr 404 000 kWh/yr x 3.6 MJ/kWh = 1 454 400 MJ/yr 1 454 400 MJ/yr / 40 MJ/kg = 36 360 kg/yr 36 360 kg/yr x 1.2 l/kg = 43 632 l/yr fuel oil
Water demand	14 000 l/d + 5 l/pig x 2 400 pigs/d = 26 000 l/d 26 000 l/d x 200 d/yr = 5 200 000 l/yr	0.7 l/pig x 2 400 pigs/d = 1 680 l/d 1 680 l/d x 200 d/yr = 336 000 l/yr
<i>Source: [29, Germany 2001]</i>		

Operational consumption levels for 'water circulation spray scalding' and 'steam scalding' are shown in Table 3.9 for plants with a capacity of 350 pigs per hour or 600 000 pigs per year.

Table 3.9: Comparison of actual consumption data of 'water circulation spray scalding' and 'steam scalding'

	Water circulation spray scalding	Steam scalding
Energy demand	4 pumps x 5 kW x 8h x 255 days = 40 800 kWh/yr	4 ventilators x 4 kW x 8h x 255 days = 32 640 kWh/yr (0.0544 kWh/pig)
Heat consumption	To heat the water bath	
	1 450 kWh x 255 days = 369 750 kWh	Not applicable
Water demand	To heat the pigs	
	3 116 kWh/pig x 600 000 = 1 869 600 kWh/yr	2.5 kWh/pig x 600 000 = 1 500 000 kWh/yr
Water demand	Daily water bath	
	25 m ³ x 255 days = 6 375 m ³	Not applicable
	Leaking loss	
	11.625 l/pig x 600 000 = 69 75 m ³	1 l/pig x 600 000 = 600 m ³
<i>Source: [29, Germany 2001]</i>		

Cross-media effects

The carcasses will have to be washed prior to scalding. If there is any dirt on the skin, this will prevent the steam from coming into contact with the skin and will result in poor scalding of the dirty part.

Technical considerations relevant to applicability

Applicability to existing plants may be restricted by the plant layout/lack of space.

Economics

The replacement of an existing scalding tank system with a condensation/steam system is not considered to be profitable, based on the water and energy savings alone. The method is, however, considered to be applicable in connection with large alterations, extensions or new buildings.

Driving force for implementation

Reduction of water and energy costs.

Example plants

One pig slaughterhouse in Germany and one slaughterhouse in Denmark [118, Denmark 2015], [204, TWG 2021].

Reference literature

[4, WS Atkins-EA 2000], [23, Nordic 2001], [29, Germany 2001], [37, Pontoppidan O. 2001], [57, Italy 2002], [108, Clitravi - DMRI 2003], [118, Denmark 2015], [156, TWG 2019].

3.3.4.1.2 Heat recovery from pig singeing exhaust gases, to preheat water

See also Section 2.3.4.1.4.

Description

The heat of the exhaust of the singeing unit is recovered to heat water.

Technical description

In pig slaughterhouses, the heat of the exhaust of the singeing unit can be recovered to heat water, e.g. to maintain the scalding tank temperature.

Achieved environmental benefits

Reduced energy use to heat water, e.g. for scalding or cleaning and reduced odour, by stopping the direct emission of hot singeing gases.

Environmental performance and operational data

Temperatures in the singeing unit can be as high as 900-1 000 °C and, if heat is not recovered, gases can be emitted at 600-800 °C. A heat recovery system, such as that shown in Figure 3.59, can be used to heat the water. In the case study shown in Figure 3.59, water is heated to 70 °C and is then used to clean the slaughterhouse.

After singeing, the exhaust contains approximately 58 % of the energy used to heat it. By installing a heat recuperation unit, 40-45 % of the applied energy can be recovered.

Economics

Two differing reports state that, based on Danish conditions, the payback time is either approximately 6 months or 3-4 years. A payback time of 1 to 3 years is reported from the UK.

Driving force for implementation

Reduced energy costs.

Example plants

The technique is used in Finnish slaughterhouses and in at least one Italian pig slaughterhouse.

Reference literature

[26, Finnish Environment Institute and Finnish Food and Drink Industries' Federation 2001], [9, DoE 1993], [23, Nordic 2001] [37, Pontoppidan O. 2001], [79, Savini F. 2002].

3.3.4.1.3 Immersion scalding with optimised water flow systems

See Section 3.4.3.2.1.

3.3.4.2 Techniques to reduce water consumption

3.3.4.2.1 Steam scalding of pigs

See Section 3.3.4.1.1

3.3.4.2.2 Recirculation of water within pig de-hairing machines

See also Section 2.3.5.1.2.

Description

The water used in pig de-hairing machines is recirculated, after it has been reheated by steam injection to the temperature required for de-hairing.

Technical description

The water used in pig de-hairing machines can be recirculated, after it has been reheated by steam injection to the temperature required for de-hairing. The water is collected in a tank, into which steam is injected to raise the temperature to that required. For food hygiene reasons, the whole system is enclosed and the water collection and recirculation is carried out under hygienic conditions. The system is discharged, cleaned and disinfected at least once a day.

Achieved environmental benefits

Reduced water consumption and energy use.

Environmental performance and operational data

Water which is entrained with the pigs as they leave the system is replaced with fresh water. This has been reported to occur at a rate of 0.7-1 m³/h for a slaughter-line producing carcasses at a rate of 55-60 t/h. Most of the water is heated from 50-55 °C to a de-hairing temperature of 55-60 °C. In the past, the water was heated to 80 -90 °C.

The operation is shown in Figure 3.60.

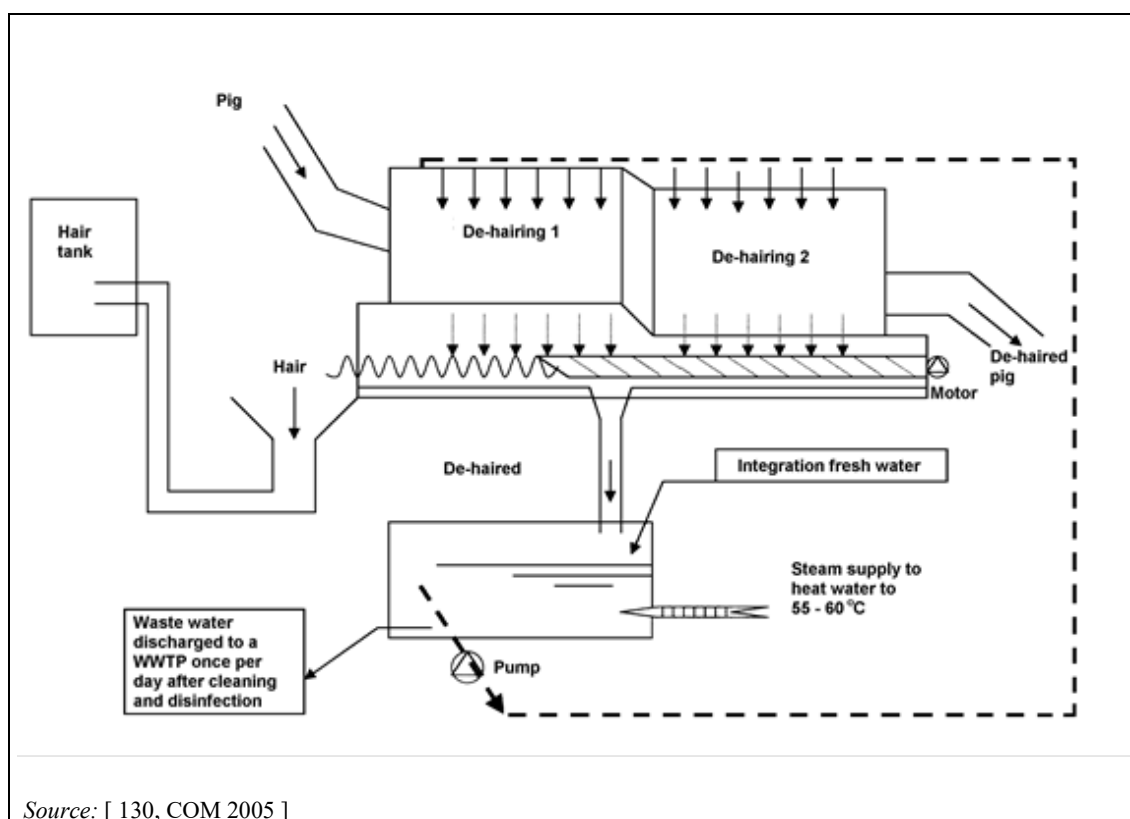

Source: [130, COM 2005]

Figure 3.60: Recirculation of water for de-hairing pigs

The use of cold water at temperatures less than 10 °C has been reported. The water has to be cooled; otherwise, the temperature rises to 30-35 °C, due to the heat from the freshly slaughtered carcasses. Less energy is required to chill the carcasses later in the process and the risk of bacterial contamination is less in the colder water.

Cross-media effects

None reported.

Technical considerations relevant to applicability

Applicable in all pig slaughterhouses.

Economics

The costs of additional water are saved by recirculating the water. In the case where water was previously heated to 80-90 °C, the money which was required to both supply and heat that water is saved.

Driving force for implementation

Reduced water and energy costs.

Example plants

At least one pig slaughterhouse in Italy.

Reference literature

[73, Italy 2002], [106, Germany 2003].

3.3.4.2.3 Reuse of cooling water from the singeing kiln

See also Section 2.3.5.1.2.

Description

Cooling water can be collected from the singeing kiln and distributed, for example to the scalding tank, post-singeing showering, or the scraping and polishing section.

Technical description

Cooling water can be collected from the singeing kiln and distributed, for example to the scalding tank, post-singeing showering, or the scraping and polishing section. A schematic diagram of the system is shown in Figure 3.61. The water can also be used for cleaning.

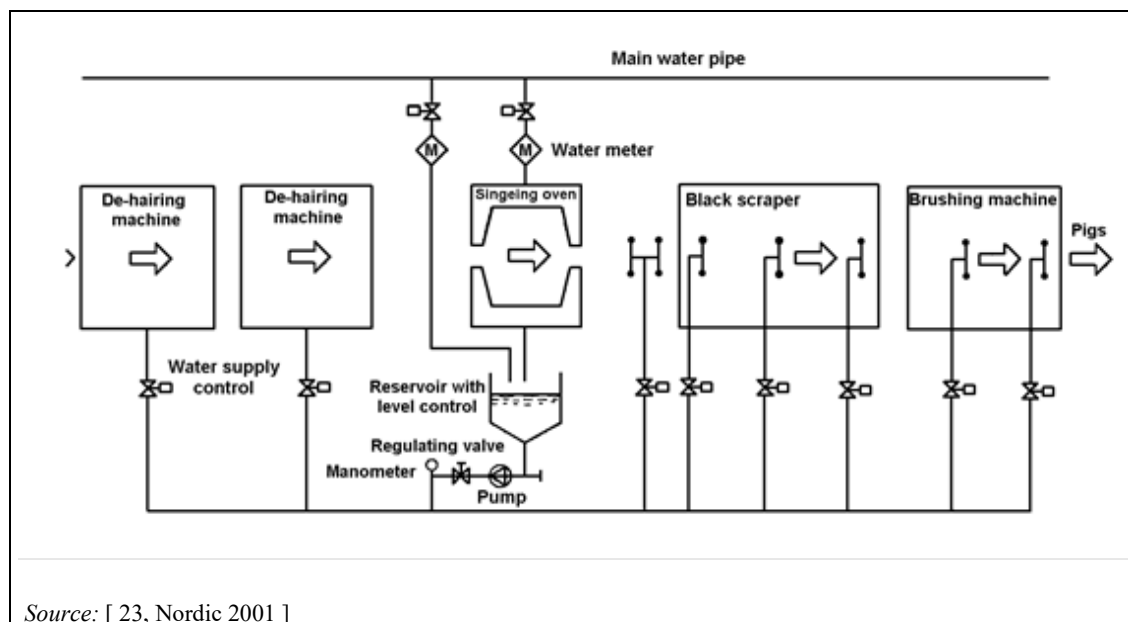

Figure 3.61: The Grinsted system reusing cooling water from a singeing kiln

Achieved environmental benefits

Reduced water consumption, by 780 l/t of carcass.

Environmental performance and operational data

The system can reduce the water consumption from more than 100 litres per pig to 20-30 litres per pig.

Cross-media effects

None.

Technical considerations relevant to applicability

All slaughterhouses which currently use a particular very thorough surface treatment, which is considered to be necessary for carcasses to be used for bacon curing.

Economics

The capital cost for a Danish slaughterhouse was reported as being approximately DKK 210 000 (cost in 2001), giving a repayment period of less than 6 months.

Driving force for implementation

Reduced water costs.

Example plants

The system is used at all of the larger Danish pig slaughterhouses.

Reference literature

[23, Nordic 2001] [37, Pontoppidan O. 2001].

3.3.4.2.4 Water level control on pig scalding tanks

Description

The spare distance from the water level to the top of the tank and to the overflow pipe can be sufficient to avoid overflow due to water displacement when the tank is filled with carcasses.

Achieved environmental benefits

Energy and water saving, by preventing the loss and need for replacement of water heated to approximately 60 °C.

Environmental performance and operational data

The control of the water level can be achieved through the fitting of an automatic level control, or by the operator filling the tank to a marked upper limit, in a tank that is sufficiently deep to contain sufficient water and the pig carcasses. Automation of the level control, if properly maintained, will remove the responsibility from the operator.

According to a Danish example, correct control of the water level can save approximately 5 m³/d.

Cross-media effects

None.

Applicability

Applicable at all pig slaughterhouses.

Economics

The capital cost is low and the payback is almost immediate.

Driving force for implementation

Reduced spending on water.

Example plants

At least one pig slaughterhouse in Denmark.

Reference literature

[23, Nordic 2001], [37, Pontoppidan O. 2001].

3.3.4.2.5 'Dry' collection of the contents of pigs' small intestines

Description

Pigs' small intestines are emptied by pulling them between a pair of rollers. Their content is collected in a tray and pumped to a container.

Technical description

The content of pigs' small intestines which are to be used as casings can be collected dry. The first stage in the cleaning involves emptying the intestines by pulling them over a pair of rollers. The content can then be collected in a tray and pumped to a container for manure, stomach content, etc. The edge must be kept wet to avoid damaging the intestines, but a minimum amount of water can be used in order to limit the dilution of the intestinal content. The wetting can be done with nozzles, and the water supply can be stopped when no intestines are present. The content of the small intestines is an easy-flowing, slimy mass. It is therefore important to ensure that there is no drainage from the collection container.

Condemned intestines and their contents can be separated prior to rendering. The intestines are cut to enable them to be separated from their contents during centrifugation. In principle, the centrifugation can be done without the use of water, other than that required for cleaning the centrifuge. Water is, however, often added to make the content so thin that it can be pumped with

a simple pump system to the manure silo. Selecting a suitable pump type and screw conveyor can eliminate the need to add water.

Achieved environmental benefits

Reduced water consumption and consequently a reduced volume and BOD loading of waste water.

The intestines can be used for sausage casings or pet food.

Environmental performance and operational data

The importance of collecting the stomach and intestinal contents dry is illustrated by the high contribution to overall waste water contamination from wet emptied stomach and intestinal contents.

Cross-media effects

None.

Technical considerations relevant to applicability

Applicable in all pig slaughterhouses.

Economics

In a slaughterhouse slaughtering 400-600 pigs per hour, the cost was reported as being approximately EUR 10 000-15 000 for collecting the stomach contents and EUR 20 000 for small intestine contents (costs in 2001).

Driving force for implementation

Reduction of pollution and its costs.

Example plants

Slaughterhouses in Denmark [118, Denmark 2015].

Reference literature

[23, Nordic 2001], [37, Pontoppidan O. 2001], [118, Denmark 2015].

3.3.4.2.6 Immersion scalding with optimised water flow systems

See Section 3.4.3.2.1.

3.3.4.3 Techniques to reduce emissions to air

3.3.4.3.1 Reduction of the pig singeing time

Description

The pig singeing time is reduced.

Technical description

The singeing unit exhaust will be virtually odour-free when the process is optimally controlled, i.e.:

- careful adjustment of the gas/air mixture;
- a reaction temperature of 600 °C to 700 °C;
- a residence time of 0.5 s to 1.0 s in the reaction zone.

Solenoid switches may be installed which initiate the singeing flame only when a carcass is passing.

Achieved environmental benefits

Reduced odour emissions and fuel consumption.

Environmental performance and operational data

No information provided.

Cross-media effects

No information provided.

Technical considerations relevant to applicability

Generally applicable to pig singeing units.

Economics

No information provided.

Driving force for implementation

Odour control at the slaughterhouse.

Example plants

No information provided.

Reference literature

[181, VDI 2020].

3.4 Slaughter of poultry

3.4.1 Applied processes and techniques

A general scheme for the slaughtering of poultry is shown in Figure 3.62.

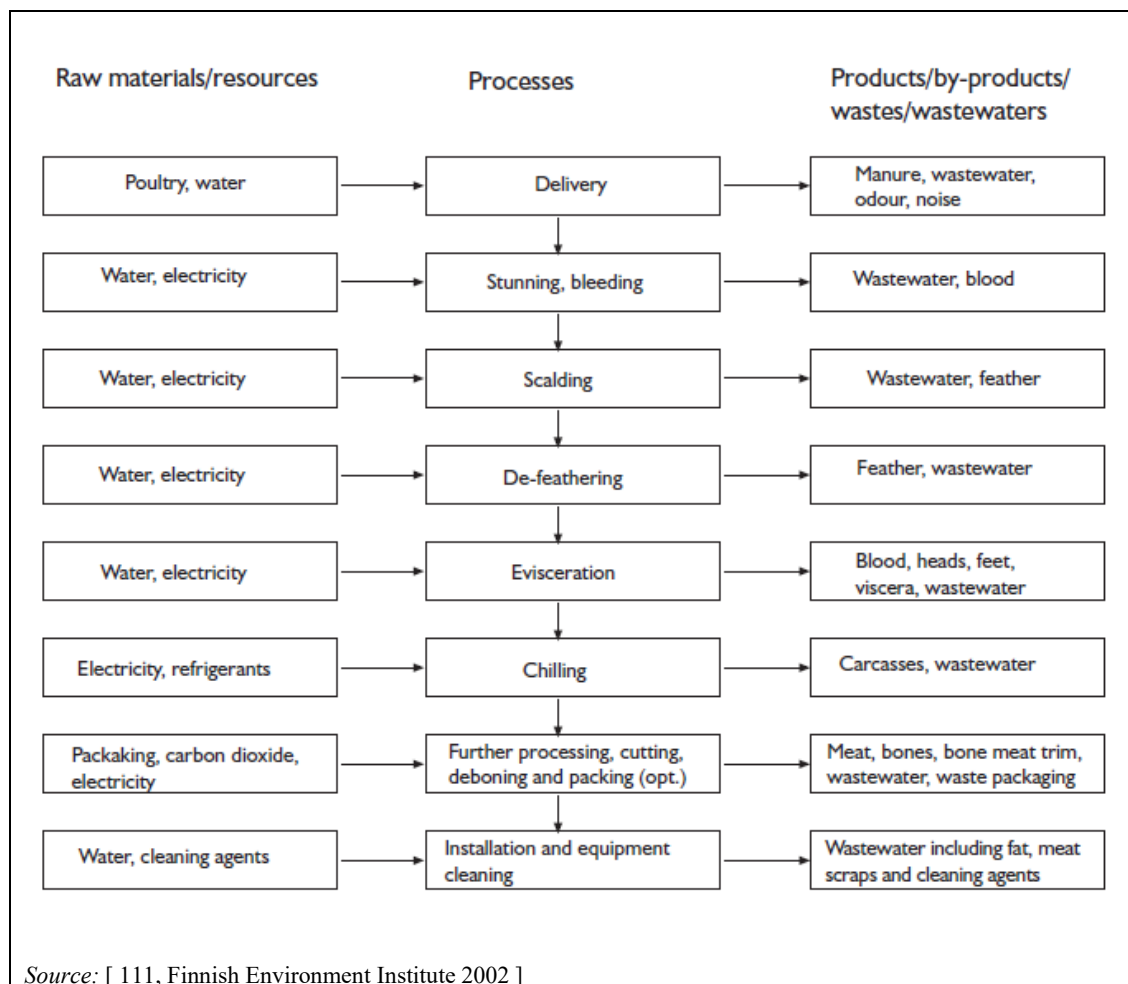

Figure 3.62: A typical flow scheme of poultry slaughtering

3.4.1.1 Reception of birds

It is essential that crates, modules and vehicles used to transport birds are thoroughly cleaned between collections, to reduce the spread of any infection which may be present. The poultry processor generally provides separate facilities for cleaning and disinfecting the crates, modules and vehicles, unless there are facilities available elsewhere at officially authorised facilities [55, COM 1992].

The withdrawal of feed prior to loading the birds for transportation to slaughter can help reduce the level of faecal contamination during transportation and, therefore, can reduce the amount of effluent produced during cleaning operations. It can also reduce the amount of crop and intestinal tract contents.

In general, crate cleaning is a three-stage process, which offers considerable opportunities for reusing and recycling water. Many of the larger poultry processors have installed automated crate-washing equipment to permit a thorough cleaning immediately following delivery of the birds. Other processors provide a variety of manual and semi-automatic cleaning facilities.

Due to the birds struggling and flapping their wings during unloading and hanging, a significant quantity of dust is produced in those areas. The dust is generally removed using exhaust ventilation and bag filters.

3.4.1.2 Stunning and bleeding

After the birds have had time to settle, they are removed from their crates/modules and put onto the killing line. They are required to be stunned, before being killed, except in the case of slaughter according to religious rites [55, COM 1992]. They are hung upside down by their feet, using shackles on a conveyor which moves them towards the stunning equipment. A commonly used stunning system uses a water bath (head only), which constitutes one electrode and a bar which comes into contact with the shackles and forms the other electrode. The bird is stunned as soon as the head comes into contact with the water. Other methods for stunning are available, mainly controlled atmosphere stunning and low-atmospheric-pressure stunning (see Section 3.4.3.1). Turkeys may be stunned using CO₂ [5, University of Guelph 2000]. EFSA has recommended the phasing out of electrical stunning methods on animal welfare grounds [183, COM 2012].

After stunning, the bird is bled for up to 2 minutes before being dressed. Bleeding may be initiated by an automatic circular knife system. The neck arteries of turkeys are sometimes cut using a handheld knife. Normal bleeding also occurs in poultry that have been killed by electrocution instead of being electrically stunned [5, University of Guelph 2000].

Since poultry are bled whilst they are hanging from a moving conveyor, the majority of poultry slaughterers collect the blood in a tunnel or walled area. The cheapest option for the disposal of blood is to collect it separately. Efficient bleeding processes and maximum blood collection in the killing tunnel are therefore essential. Well-designed blood tunnels need to be long enough and have high enough walls to capture all the spurting blood from freshly killed birds.

The blood trough is normally fitted with a double drain, one opening for the blood to be pumped to a tanker for disposal and the other for wash-water. Removable plugs seal the openings when they are not in use.

During bleeding, blood coagulates on the base/walls of the trough. This is either hosed down and washed directly to the WWTP or in some slaughterhouses it is collected by shovels, squeegees or by vacuum suction and as much as possible is pumped to a blood tanker. This coagulated blood can be rendered, with the other poultry blood. In most slaughterhouses, the blood trough is pitched and curved so that partially congealed blood can be directed into the drain and to the blood tanker. If the coagulated blood is collected first, a few litres of water can, usually with the permission of the renderer, be used to rinse blood into the blood tanker. The plug in the drain leading to the WWTP is then opened and the whole trough is washed down with water.

Some slaughterhouses allow all or a significant proportion of the blood they collect to run to their WWTP. The WWTP in these cases needs to be capable of treating the high COD and BOD. This may incorporate the production of biogas. It is more usual for poultry blood to be sent for rendering [74, Casanellas J. 2002].

Excessive body movement of the slaughtered poultry may splatter blood on to the conveyor, out of the bleeding area and onto the feathers of adjoining birds, where it will be washed off in the scalding process. Ensuring that the birds are adequately stunned at slaughter will reduce such movements, allowing more efficient blood collection and reducing waste water effluent strength.

3.4.1.3 Scalding

After stunning and bleeding, the birds are immersed in a scalding tank to loosen the feathers to facilitate defeathering. Scalding loosens the feathers by softening the feather follicles. The process can be performed by immersing the broilers in a long, hot water bath. It is usually a series of several baths in succession. When applying hot water scalding in a tank, there must be good water movement and a uniform water temperature to ensure that the heat penetrates well everywhere.

Birds destined to be sold frozen are usually 'hard scalded' at 56-58 °C. Carcasses to be air-chilled, for fresh sale, are most often 'soft scalded' at 50-52 °C to avoid damage to the cuticle and resultant skin discolouration. In the Nordic countries, chickens for freezing are scalded at approximately 58-60 °C and chickens for chilled distribution are scalded at approximately 50-51 °C [108, Clitravi - DMRI 2003].

As birds enter the scalding tank they may involuntarily defecate, leading to the accumulation of faecal materials in the water. In water, poultry faeces dissociate to form ammonium nitrate and uric acid which form a natural buffer which has the effect of maintaining the scalding tank at about pH 6, the point at which salmonellas are most heat-resistant. In most cases, the scalding tanks are emptied into the wet feather flume at the end of the day shift.

3.4.1.4 Defeathering

Feathers are removed mechanically, immediately after scalding, by a series of on-line plucking machines. The machines comprise banks of counter-rotating stainless steel domes or discs, with rubber fingers mounted on them. Rubber flails mounted on inclined shafts are sometimes used for finishing. Any feathers remaining on the bird after mechanical plucking, including pin feathers, are removed by hand. In Finland, defeathering may be performed by rubbing the scalded carcass with rotating rubber fingers and using pressurised water jets.

Continuous water sprays are usually incorporated within the machines for flushing out feathers. Feathers are commonly taken to a centralised collection point via a fast-flowing water channel located below the machine. The feathers may then be sent for rendering, composting, co-incineration with chicken litter in large combustion plants, or landfill, although the latter is becoming less available as an option [60, United Kingdom 2002]. Dry feather collection systems, using a conveyor belt in conjunction with a vacuum or compressed air arrangement, are sometimes used, e.g. if the feathers are to be supplied to the feather/down industry.

After plucking, the surfaces of the chickens are cleaned by showering, possibly combined with beater straps. The chickens are then transferred from the unclean part of the slaughter-line to where the clean processes are carried out, known as the clean slaughter area. They are then inspected externally and the heads and feet are cut off. Some slaughterhouses have equipment for cleaning the feet for human consumption. The feet are cleaned with water at 80 °C. The equipment is only used when there is a viable market for this product.

For ducks, wax is used to remove the feathers. The ducks are dipped in a bath of hot wax and then passed through cool water sprays so that the wax hardens. The hardened wax, with the feathers attached, is either mechanically or hand stripped. The plucked carcasses are then spray-washed. The wax is melted and recycled.

3.4.1.5 Evisceration

After defeathering and head and feet removal the birds are eviscerated, i.e. the internal organs are removed. In the majority of production sites, evisceration is carried out mechanically, but manual evisceration is still practised in some of the smaller companies. On automated lines, a cut is made around the vent, a spoon-shaped device is inserted into the opening and the viscera are withdrawn.

Common practice is to allow the viscera to remain attached by their natural tissues and to hang them over the back of the carcass for post-mortem inspection. Some modern machinery holds the birds horizontally by the head and hocks so that when the viscera are removed from the body cavity they come out sideways and are placed on a tray beside the bird.

Hearts, necks, gizzards and livers can be transported with iced water to containers for collection from the slaughter-line for storage and distribution, for either human consumption or pet food, depending on the market prices. This integrated transport and cooling system means that separate chilling of these organs is not required.

3.4.1.6 Chilling

After evisceration and inspection, fresh poultry meat must be cleaned immediately and chilled in accordance with hygiene requirements to a temperature not exceeding 4 °C. There are several designs of chilling equipment used; the most popular are spray chillers, air-chillers, multistage chillers and combi chillers. Immersion chillers are applied in a very limited number of poultry plants. More than 70 % of the EU poultry slaughterhouses apply an air-chilling system [156, TWG 2019].

Refrigeration plants operate continuously and the condensing units, compressors and cooling towers associated with them can be a source of noise. Refrigerated trucks parked outside slaughterhouses can sometimes lead to noise problems if the refrigeration is powered from the truck engines. Many slaughterhouses provide mains power cables to power the refrigeration unit, thereby reducing the noise levels.

Poultry carcasses and parts must not be water-chilled by simple immersion in a container of cold water.

Spray chillers

These avoid the problems associated with the build-up of contamination in chiller tanks, but they can give rise to the spread of bacteria through aerosols. Spray chillers may also use high volumes of water, reportedly up to 1 litre of water per bird. Spray chilling has the lowest energy consumption.

Air-chillers

These are generally used when the carcasses are destined for sale fresh. Chilling is either carried out in batches in a chill room or by continuous air blast. Tests have shown that air-chilling can reduce the contamination rate by up to three times more than immersion chilling [13, WS Atkins-EA 2000].

Most chicken processors have now switched to air-chilling because this uses the least amount of water and extends the shelf life of the product. Water-chilling is, however, widely used by turkey processors in order to comply with hygiene requirements for rapid chilling of these larger carcasses. After spending about an hour in a countercurrent immersion chilling tank to reduce the carcass temperature, the turkeys are further chilled for 24 hours by loading 30-40 birds into 1 m³ tanks filled with water at 0-1 °C and ice at -8 °C, to achieve the requirement for the water temperature of the final chiller to be less than 4 °C [13, WS Atkins-EA 2000], [63, AVEC 2002]. Air-chilling can cause dehydration of the carcass, but it helps to preserve the flavour of the poultry meat and can help the product command a premium price [5, University of Guelph 2000].

Multistage chillers

In multistage tunnels, the cold room is subdivided into two or three sections - or stages - each with its own air velocity and air temperature. This system helps to bring down dehydration, subsequent yield loss and energy consumption. Spraying can be applied in the first section, even for products with epidermis.

Combi chillers

In a combined chilling tunnel, drag chilling is applied in the first phase of the chilling process. The products are immersed in a water bath while remaining hanging in the shackles of the overhead conveyor. A typical drag chilling line would comprise following phases:

- 6 minutes of drag chilling;
- 2 minutes of drip line;
- 2 minutes of drag chilling;
- 45-80 minutes of air-chilling depending on bird weight and product end temperature.

The water bath used for drag chilling comprises long stainless steel tanks, optionally provided with a glycol coolant circuit. A separate glycol chilling system is required. Since the carcasses drag some water from the tank on leaving, the water bath is placed on the floor of the tunnel.

A multilayer air/combi chiller is a very efficient method of chilling compared with a single-layer air-chilling system [156, TWG 2019].

3.4.1.7 Maturation

Where carcasses require maturation after chilling, further conditioning using a refrigeration medium (air, ice, water or other food-safe process) can be used which may continue the cooling of the carcass or carcass parts. For instance, the birds can be immersed in stainless steel tanks in water and ice, to cool them to 1 °C. They are then stored in a room with temperature control at 0-1 °C for up to 24 hours [49, AVEC 2001], [109, AVEC 2003].

3.4.2 Current consumption and emission levels

3.4.2.1 Chicken slaughterhouses

This section presents data for installations exclusively slaughtering chickens.

3.4.2.1.1 Energy consumption

3.4.2.1.1.1 Specific net energy consumption in kWh/tonne of carcass

Figure 3.63 shows data (from installations participating in the data collection, for the years 2016 to 2018) in relation to total specific net energy consumption in kWh/tonne of carcass at installation level, as well as the applied techniques to reduce energy consumption.

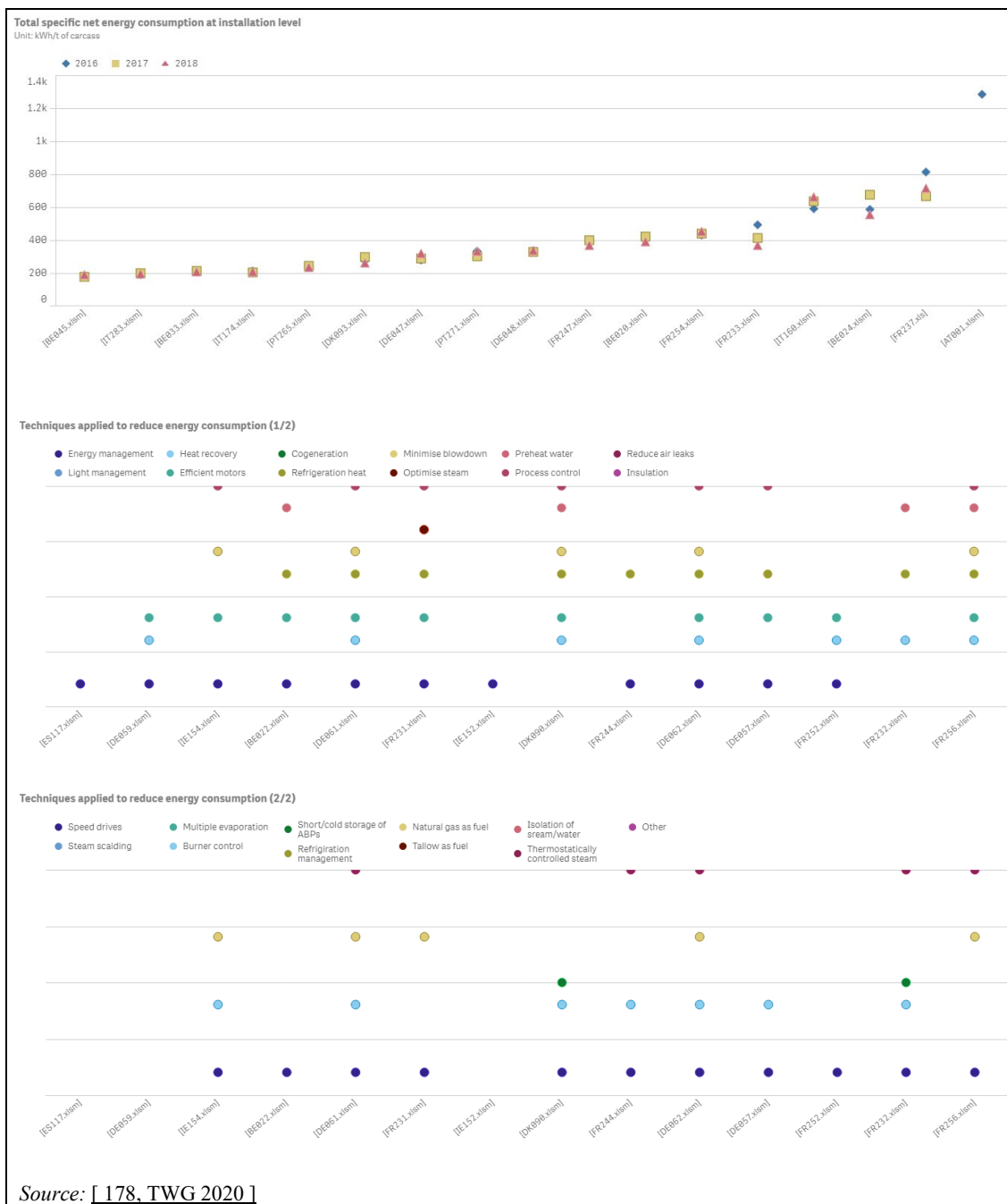

Figure 3.63: Specific net energy consumption (kWh/tonne of carcass) and applied techniques to reduce energy consumption in chicken slaughterhouses (installation level)

Figure 3.64 shows data (from installations participating in the data collection, for the years 2016 to 2018) in relation to total specific net electricity and heat consumption in kWh/tonne of carcass at installation level.

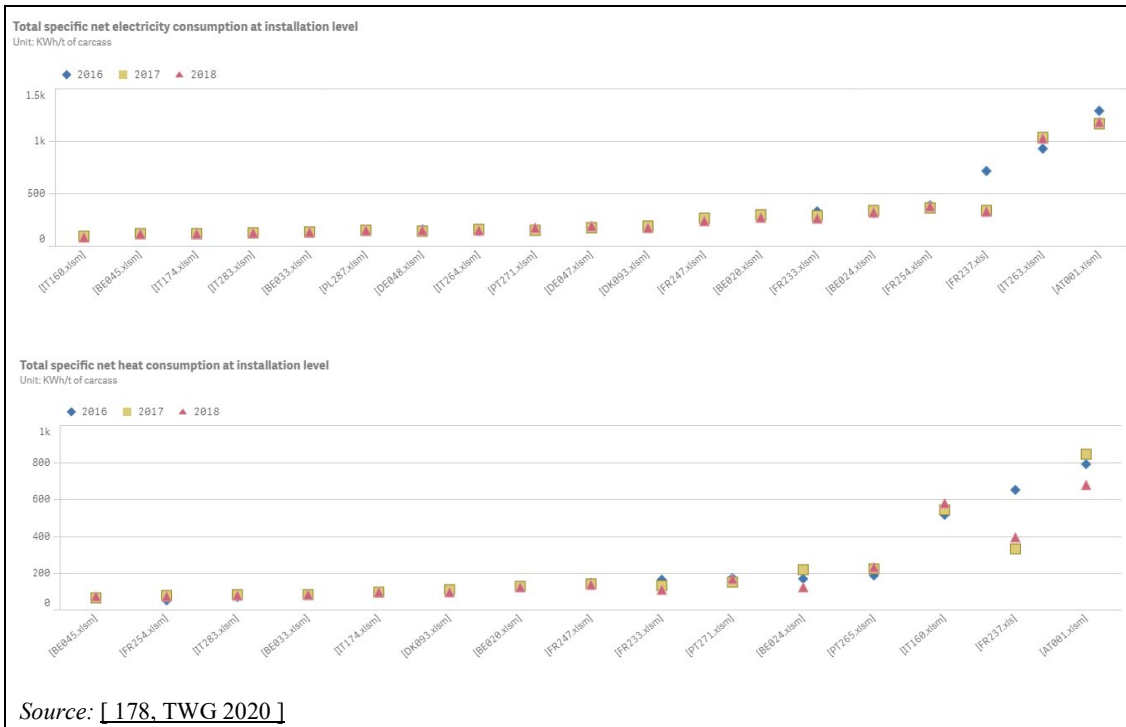

Figure 3.64: Specific electricity and heat consumption (kWh/tonne of carcass) in chicken slaughterhouses (installation level)

Figure 3.65 shows the specific net energy consumption (from installations participating in the data collection, for the years 2016 to 2018) in kWh/tonne of carcass, for the cooling systems process.

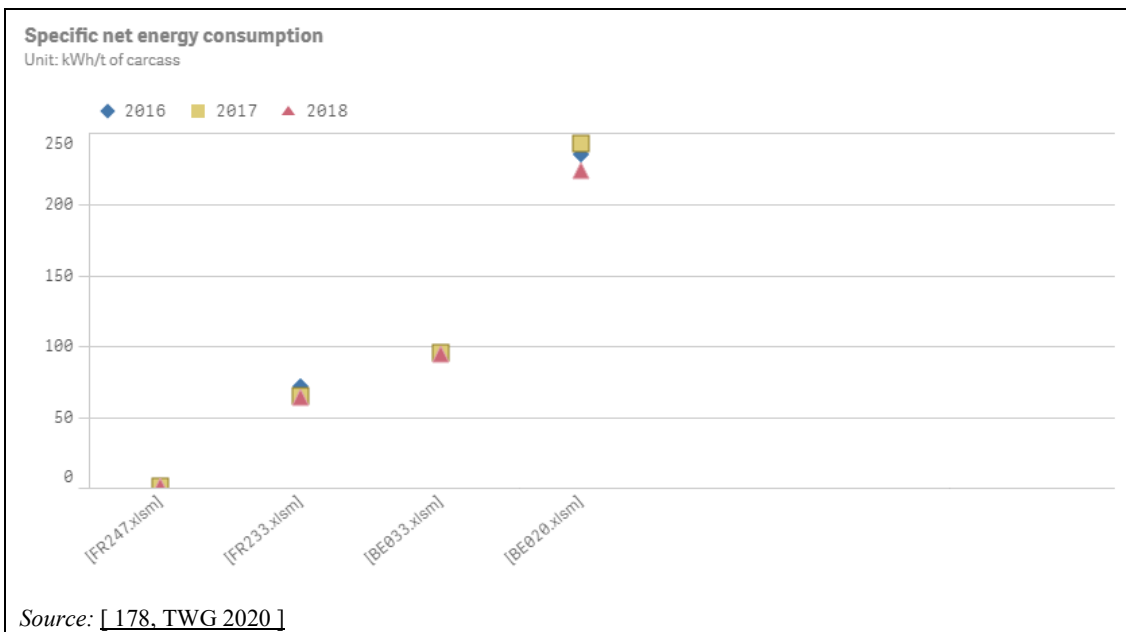

Figure 3.65: Specific net energy consumption (kWh/tonne of carcass) for cooling systems in chicken slaughterhouses

3.4.2.1.1.2 Specific net energy consumption in kWh/animal

Figure 3.66 shows data (from installations participating in the data collection, for the years 2016 to 2018) in relation to total specific net energy consumption in kWh/animal at installation level, as well as the applied techniques to reduce energy consumption.

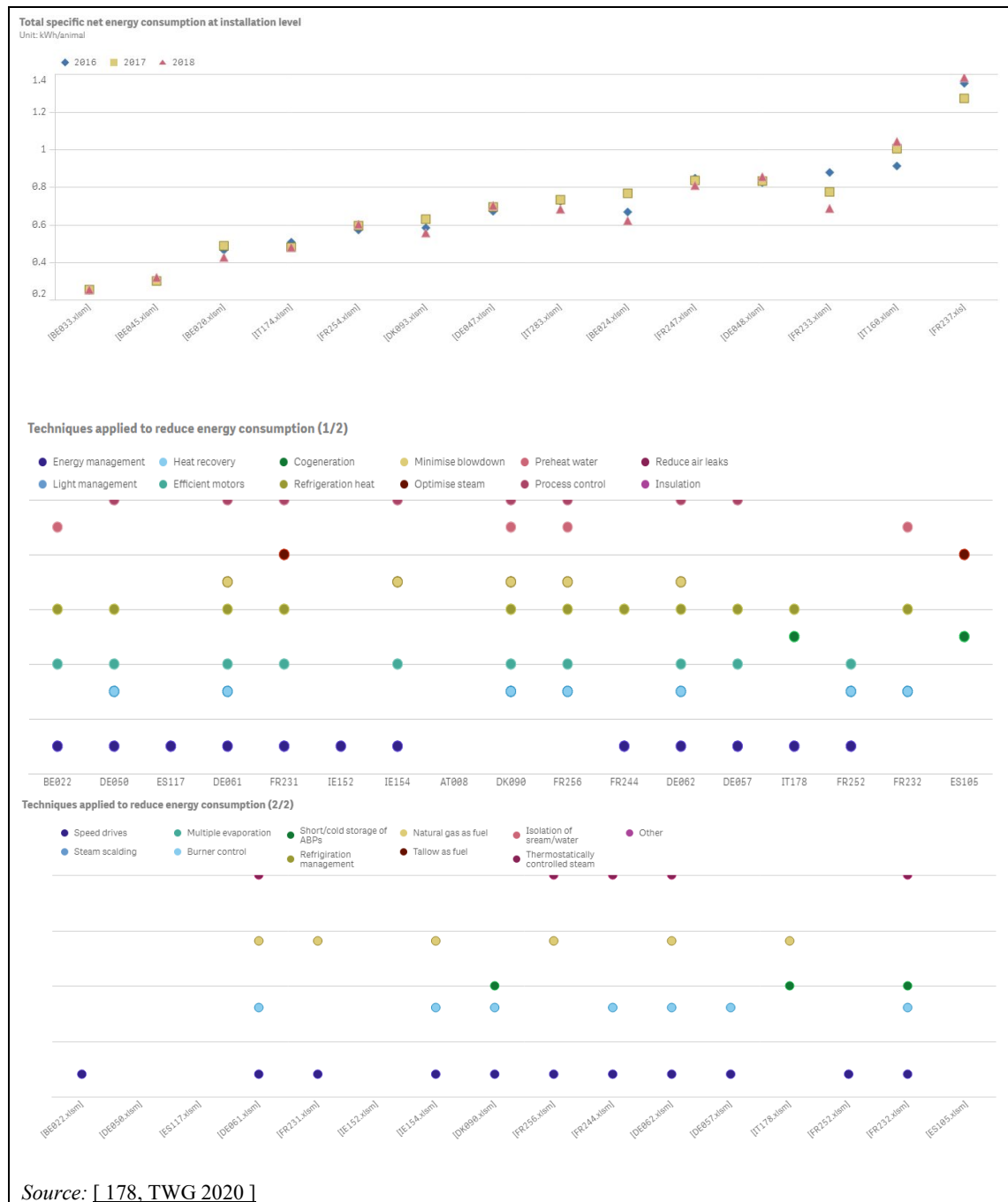

Figure 3.66: Specific net energy consumption (kWh/animal) and applied techniques to reduce energy consumption in chicken slaughterhouses (installation level)

Figure 3.67 shows data (from installations participating in the data collection, for the years 2016 to 2018) in relation to total specific net electricity and heat consumption in kWh/animal at installation level.

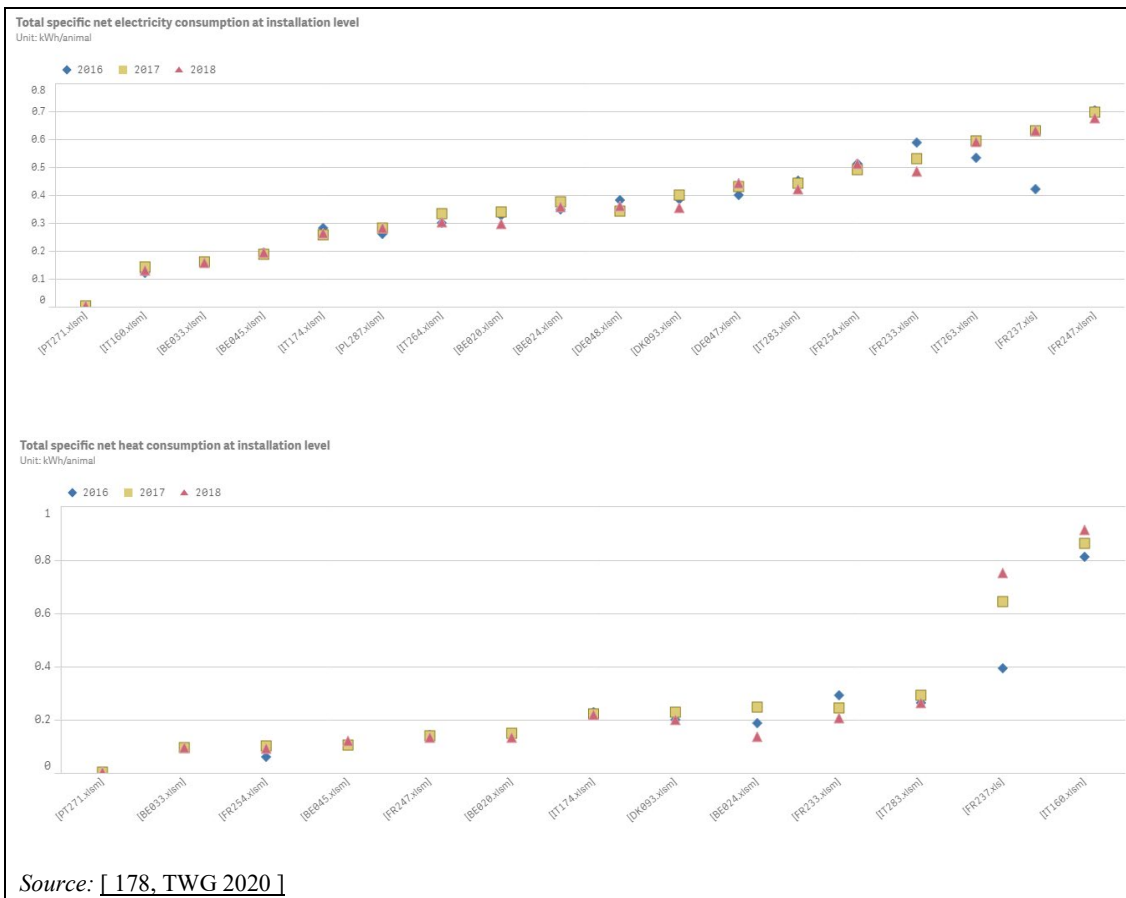

Figure 3.67: Specific net electricity and heat consumption (kWh/animal) in chicken slaughterhouses (installation level)

Figure 3.68 shows the specific net energy consumption (from installations participating in the data collection, for the years 2016 to 2018) in kWh/animal, for the cooling systems process.



Figure 3.68: Specific net energy consumption (kWh/animal) for cooling systems in chicken slaughterhouses

3.4.2.1.2 Water consumption

Cold or hot potable water is used to wash crates. Detergents are added because crates are a potential source of microbiological risk from, for example, *Salmonella*. The strength of detergent used depends on the species of poultry. High-strength detergent is used for turkeys.

Water is virtually always used to wash the birds and transport the feathers away. The wet transportation of feathers creates the potential for water contamination. It also adds moisture to the feathers, which naturally hold a lot of water. This increases the energy required to transport them during further processing. It also increases the amount of energy required to drive off moisture during rendering and the amount of condensate produced. If the feathers are landfilled the additional moisture may also create leachate problems.

The birds are washed in potable water, which in some MSs is chlorinated. In the UK for example, the washing is undertaken with water chlorinated, e.g. with chlorine dioxide, at a concentration approved for potable water [60, United Kingdom 2002].

3.4.2.1.2.1 Specific net water consumption in m³/tonne of carcass

Figure 3.69 shows data (from installations participating in the data collection, for the years 2016 to 2018) in relation to total specific net water consumption in terms of m³/tonne of carcass at installation level.

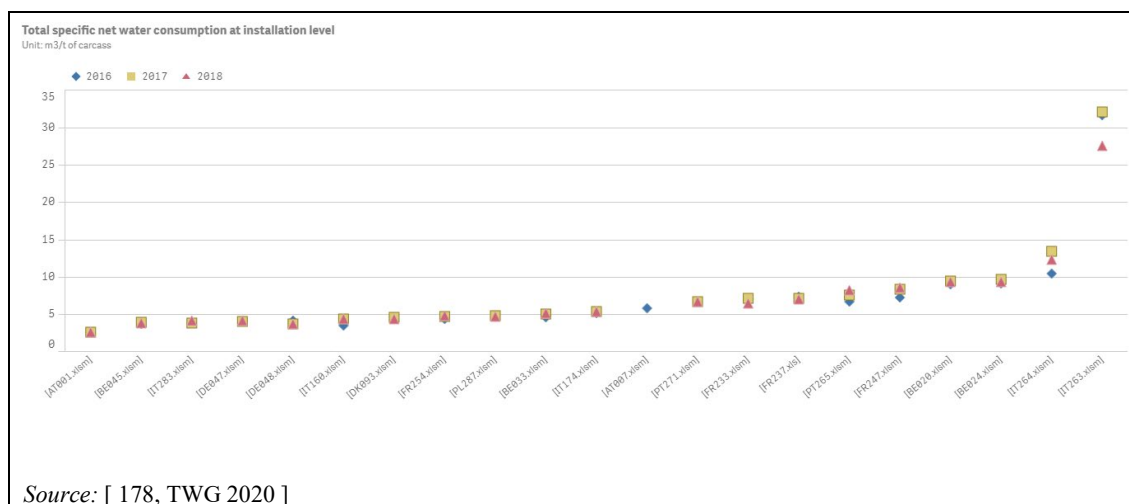

Figure 3.69: Specific net water consumption (m³/tonne of carcass) for chicken slaughterhouses (installation level)

Figure 3.70, Figure 3.71 and Figure 3.72 show the specific net water consumption (from installations participating in the data collection, for the years 2016 to 2018) in m³/tonne of carcass, for various processes in chicken slaughterhouses.

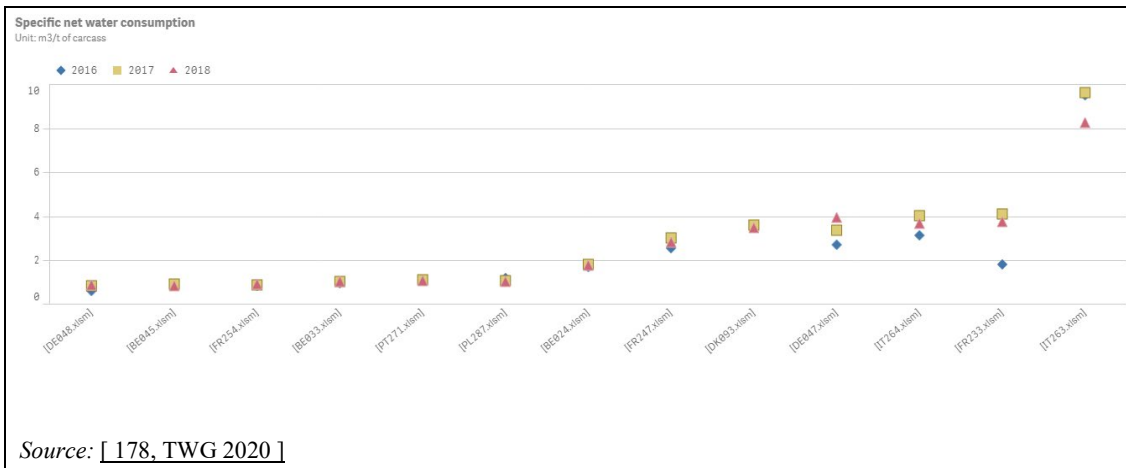

Figure 3.70: Specific net water consumption (m³/tonne of carcass) for cleaning of floors/walls and equipment in chicken slaughterhouses

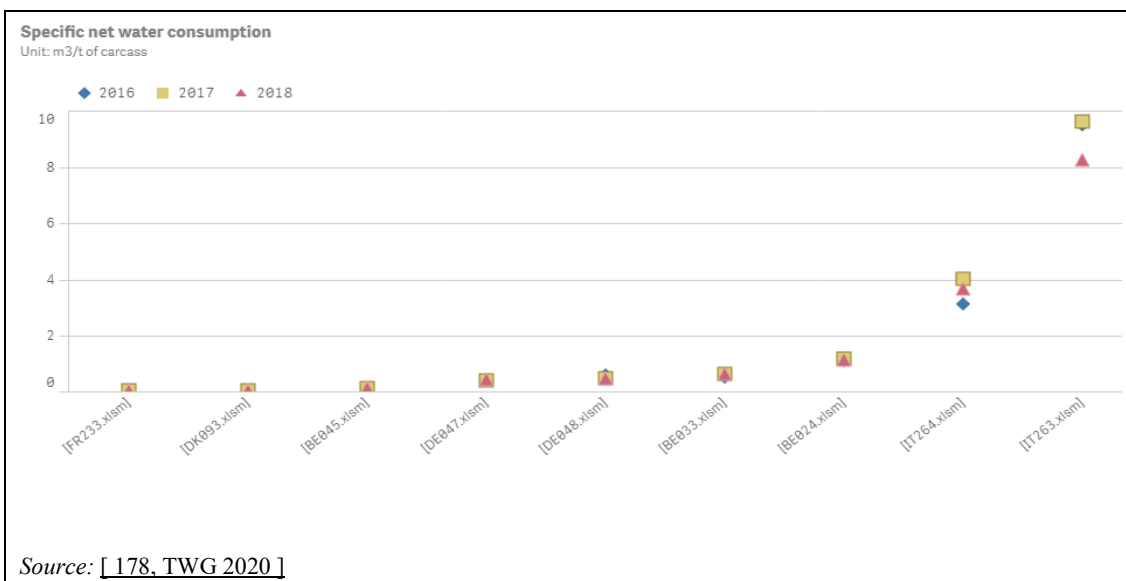

Figure 3.71: Specific net water consumption (m³/tonne of carcass) for defeathering in chicken slaughterhouses

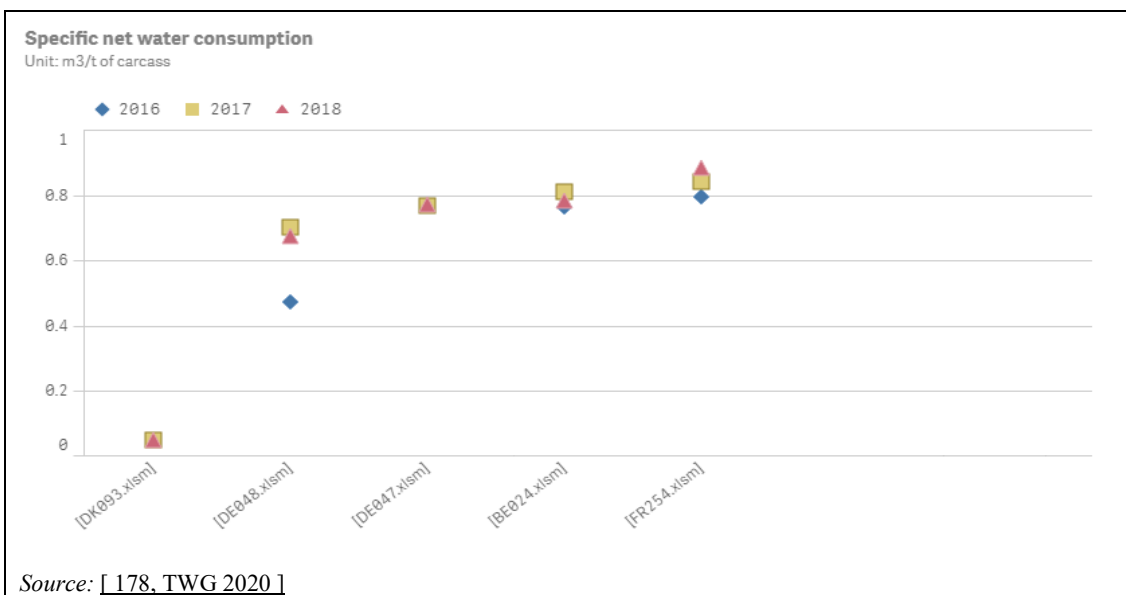

Figure 3.72: Specific net water consumption (m³/tonne of carcass) for handling of casings and offal in chicken slaughterhouses

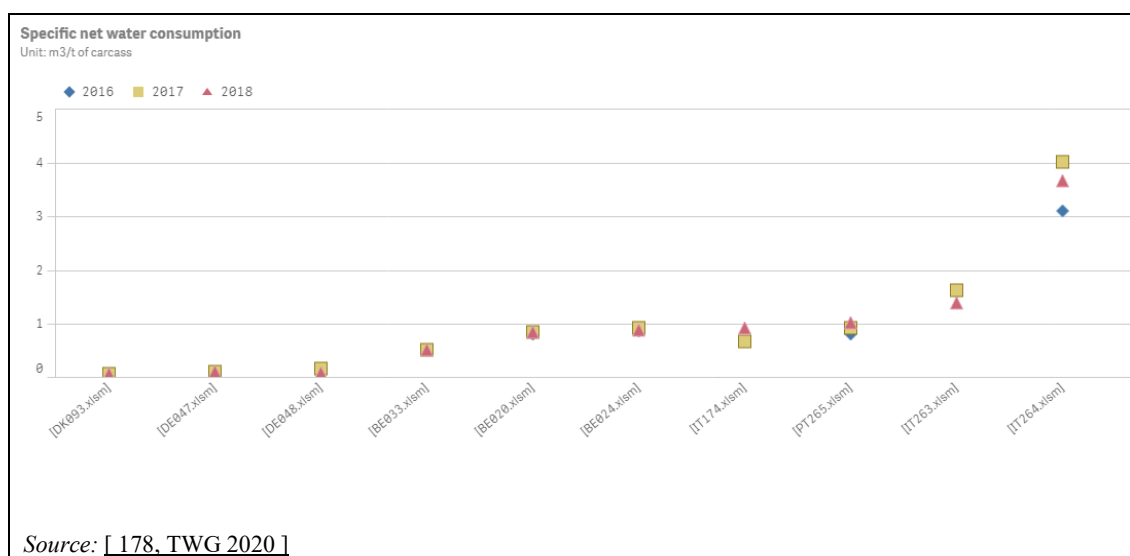

Figure 3.73: Specific net water consumption (m³/tonne of carcass) for vehicle washing in chicken slaughterhouses

3.4.2.1.2.2 Specific net water consumption in m³/animal

Figure 3.74 shows data (from installations participating in the data collection, for the years 2016 to 2018) in relation to total specific net energy consumption in terms of m³/animal at installation level.

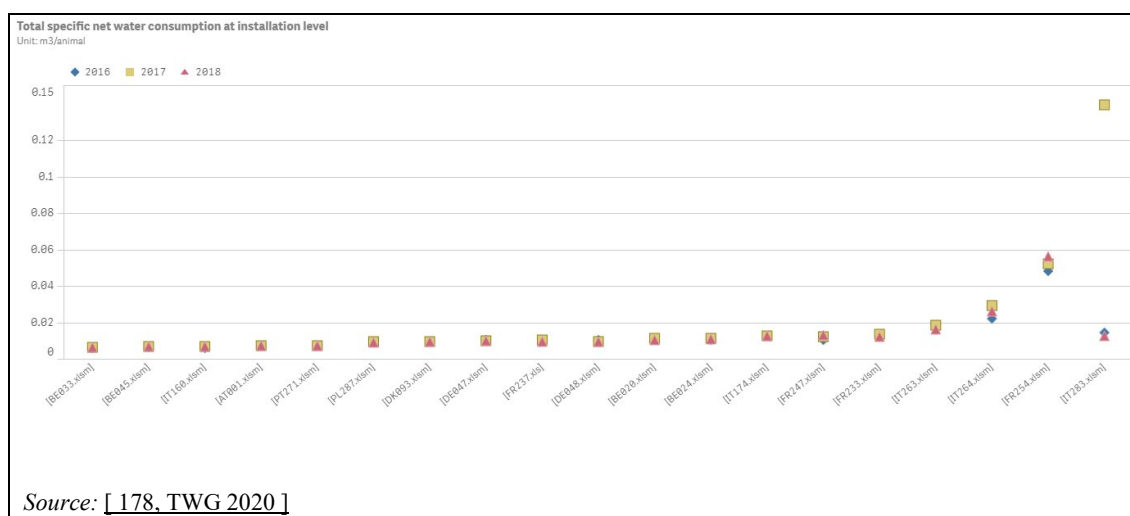

Figure 3.74: Specific net water consumption (m³/animal) for chicken slaughterhouses (installation level)

Figure 3.75, Figure 3.76, Figure 3.77 and Figure 3.78 show the specific net water consumption (from installations participating in the data collection, for the years 2016 to 2018) in m³/animal, for various processes in chicken slaughterhouses.

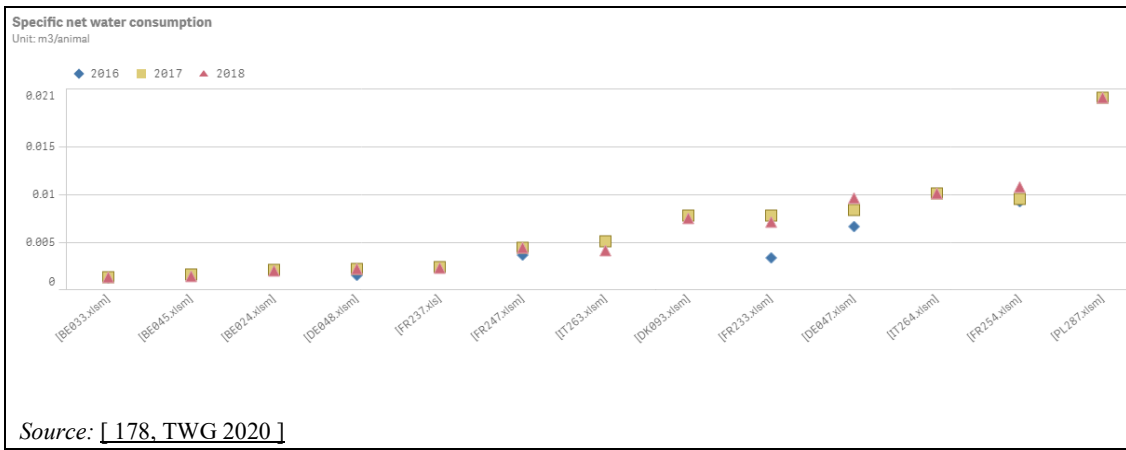

Figure 3.75: Specific net water consumption (m³/animal) for cleaning of floors/walls and equipment in chicken slaughterhouses

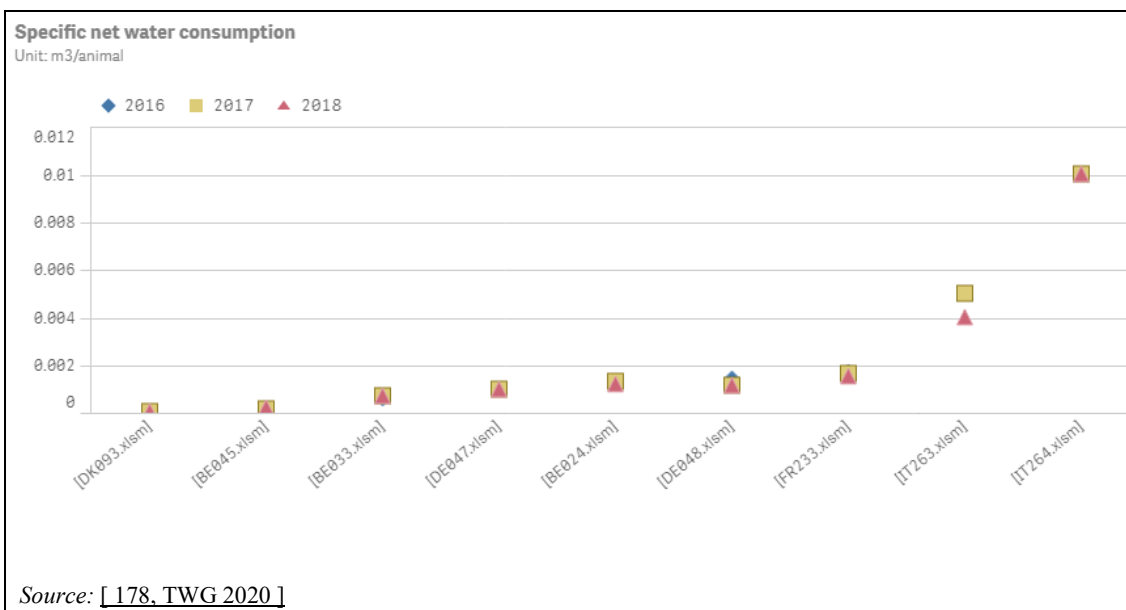

Figure 3.76: Specific net energy consumption (m³/animal) for defeathering in chicken slaughterhouses

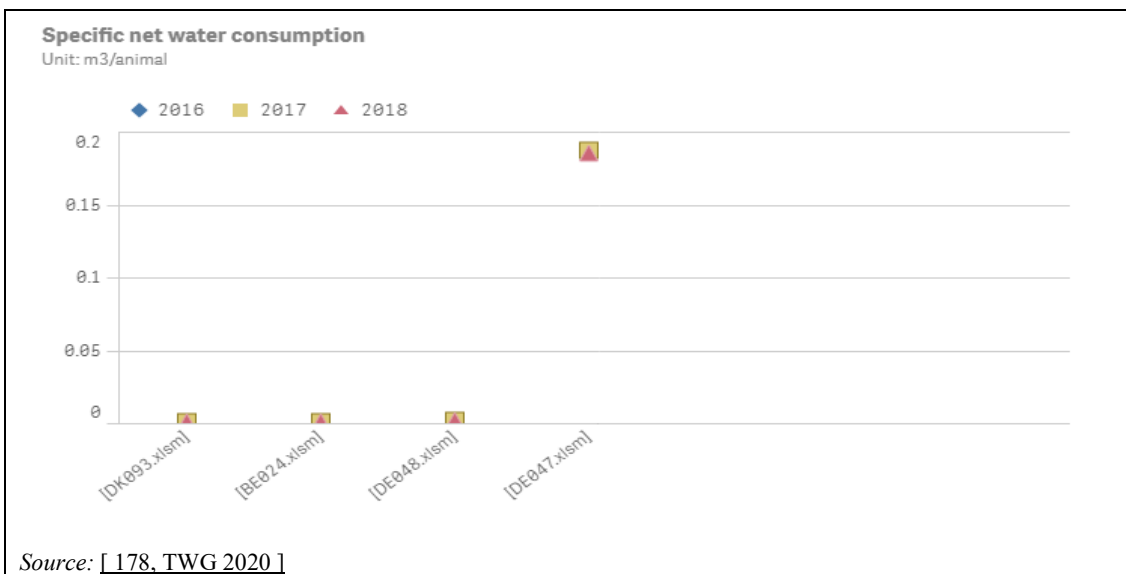

Figure 3.77: Specific net water consumption (m³/animal) for handling of casings and offal in chicken slaughterhouses

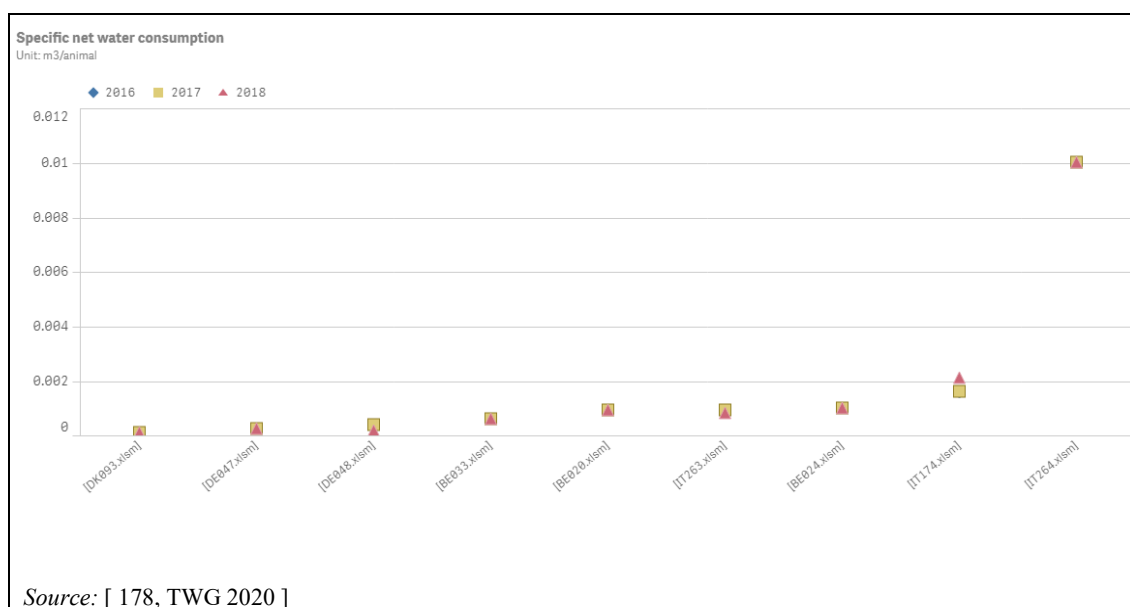

Figure 3.78: Specific net water consumption (m³/animal) for vehicle washing in chicken slaughterhouses

3.4.2.2 Emissions to water

Figure 3.79 shows reported data (from installations participating in the data collection, for the years 2016 to 2018) on specific waste water discharges per emission point (in m³/tonne of carcass), from chicken slaughterhouses and all types of discharges, as well as the applied techniques to reduce water consumption.

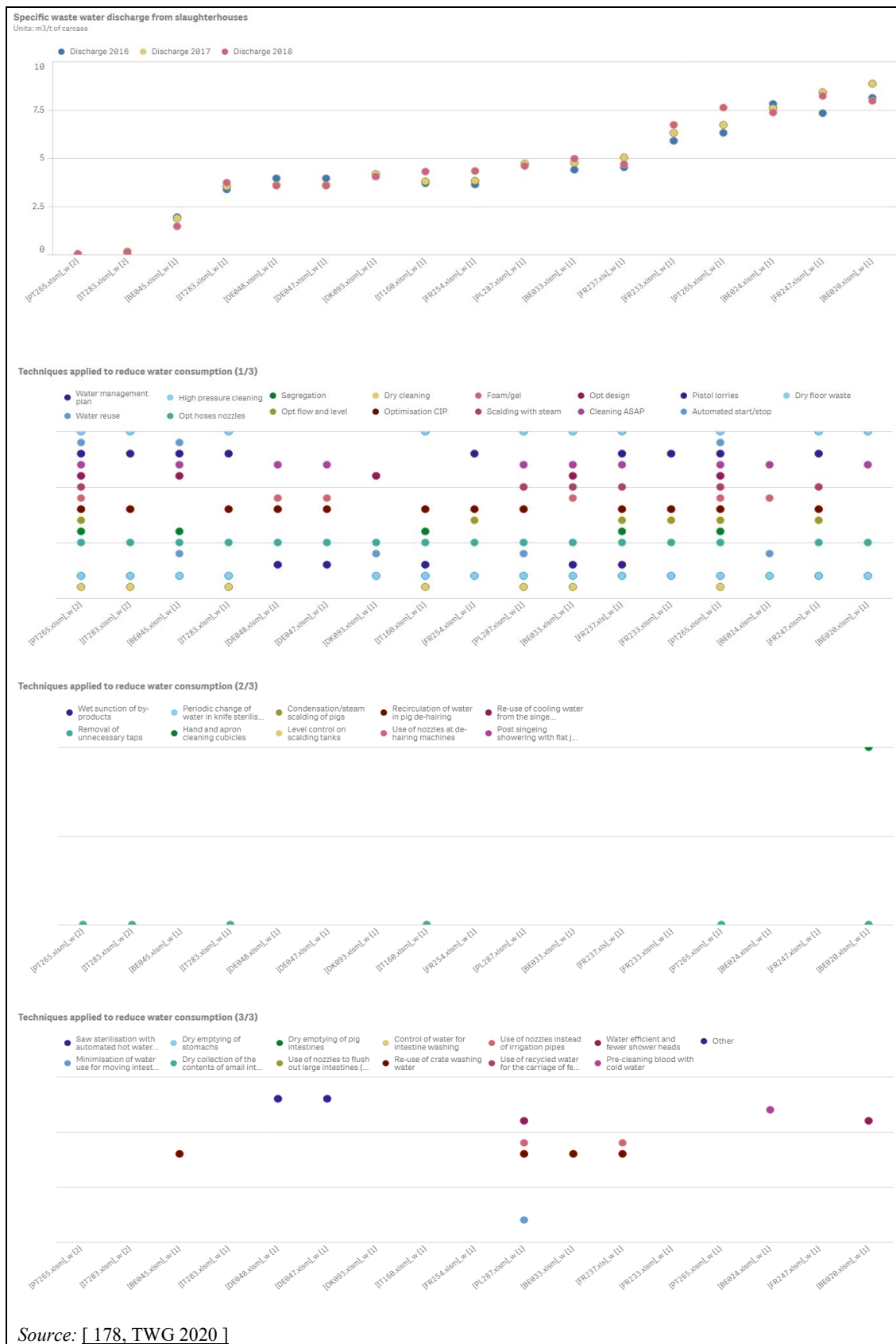

Figure 3.79: Specific waste water discharge per emission point (m³/tonne of carcass) in chicken slaughterhouses for all types of discharges and applied techniques to reduce water consumption

Figure 3.80 shows reported data (from installations participating in the data collection, for the years 2016 to 2018) on specific waste water discharges per emission point (in m³/animal), from

chicken slaughterhouses and all types of discharges, as well as the applied techniques to reduce water consumption.

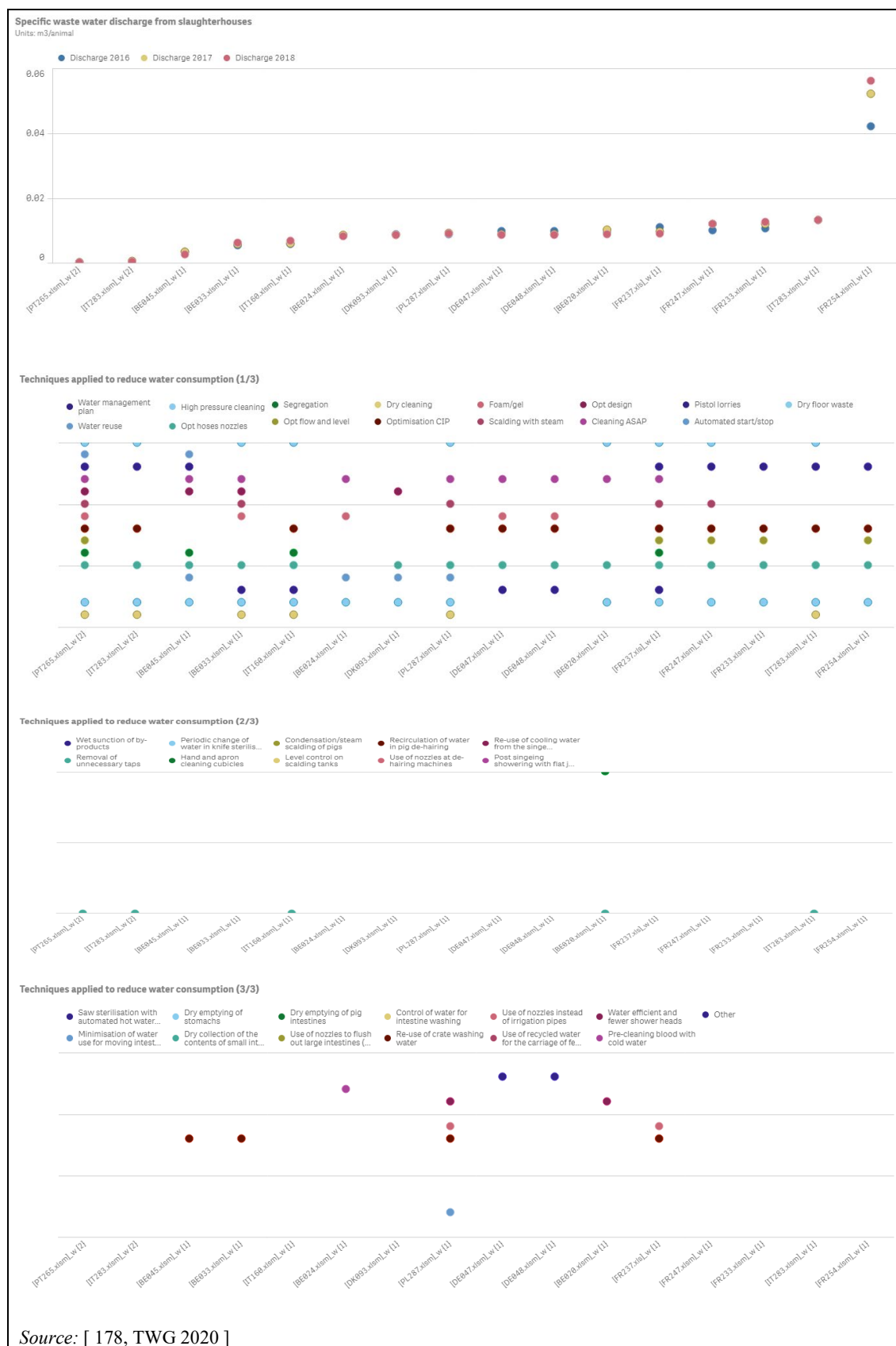

Figure 3.80: Specific waste water discharge per emission point (m³/animal) in chicken slaughterhouses for all types of discharges and applied techniques to reduce water consumption

Blood has the highest COD strength of any liquid effluent arising from poultry slaughter operations. Poultry blood has a COD strength of about 400 g/l, which would lead to a doubling of the effluent strength at a typical poultry slaughterhouse if it was allowed to enter the waste water stream.

3.4.3 Techniques to consider in the determination of BAT

3.4.3.1 General environmental performance

3.4.3.1.1 Low-atmospheric-pressure stunning

Description

Birds are rendered unconscious from a lack of oxygen by the use of reduced oxygen tension.

Technical description

During the slaughter process, chickens are frequently stunned before being killed using an electrical water bath (electrical stunning) and, more recently, through controlled atmosphere stunning (CAS) by using inert gas mixtures. Low-atmospheric-pressure stunning (LAPS) is an alternative technique using reduced oxygen tension to render the birds unconscious from a lack of oxygen [133, Vizzier-Thaxton et al. 2010].

Lower pressure is achieved through slow decompression of the air in a sealed chamber using a vacuum pump (Figure 3.81). Birds are placed in the chamber and rendered unconscious by a gradual reduction of oxygen, leading to a progressive deprivation of adequate oxygen supply to the birds' organs. The loss of consciousness is therefore gradual, as with CAS, and potentially painless because no air is trapped within the body cavities [134, The Poultry Site 2019].



Figure 3.81: Low-atmospheric-pressure stunning system

The LAPS system works as follows [135, COM 2012]:

- standard transport modules are put onto a rail by forklift and led to the vacuum chambers;
- the transport modules enter one of the chambers at a time;
- the chamber is sealed, and air is gradually extracted over a 4-minute period, causing anoxia;
- the unconscious birds are then tipped out and shackled.

Achieved environmental benefits

LAPS offers various advantages over traditional electric water baths:

- Reduced unusable waste streams (losses in the water bath due to fractures and bleeding).

- Reduced dust production due to wing flapping.
- Reduced water use and consequently waste water production.
- Improved hygiene as the birds do not defecate on themselves.

Environmental performance and operational data

Compared to the traditional electric water bath, the LAPS system obtains (data for a specific case of 12 000 birds/hour, [135, COM 2012]) > 80 % reduction in water use at the stunning stage (this relates to a saving of 10 950 m³/year of water).

Cross-media effects

Increased energy use with LAPS compared to the traditional electric water bath (13-16 kW compared to 0.5-1.5 kW for a capacity of 12 000 birds/hour).

Technical considerations relevant to applicability

None.

Economics

Table 3.10 shows an estimate of the costs for the different stunning systems which can be used in a bird slaughterhouse, with a capacity of 12 000 birds/hour. The overall cost per bird of LAPS is about 5 % higher than traditional water baths.

Table 3.10: Economic differences of stunning procedures (water bath/head only, CAS, LAPS)

Cost factor	Water bath/head only	CAS	LAPS
Installation cost (EUR)	370 000	308 300	500 000
Maintenance (% of installation cost)	3.00	6.90	2.40
Labour for reception and hanging (hours/day)	96	90	90
Water for stunning and cleaning (m ³ /day)	0.96	3.5	3.5 (max)
Electricity (kWh/day)	9.6	127	1,136
Gas used	-	3.1 tonnes/day	-
Other labour (hours/day)	0.5	5	5
EU average cost per bird (EUR/bird)	0.02521	0.03495	0.02641
Cost per bird including labour, water, electricity (EUR/bird)	0.04151	0.05105	0.04367
<i>Source: [135, COM 2012]</i>			

Driving force for implementation

During this procedure the birds are in darkness, which could therefore reduce the stress of the stunning procedure. Different studies suggest that there are no pain-inducing effects of the LAPS systems [136, McKeegan et al. 2013]. However, the European Food Safety Authority conducted a review of several documents presented by the EC and concluded that 'it is unclear from the submitted documents [...] that LAPS induced unconsciousness and death without causing avoidable pain' [137, EFSA 2014]. More research on the physiological responses of poultry to LAPS is therefore suggested.

This system offers the advantage for the workers of not having to handle and shackle live birds because they are stunned directly in their transport containers.

Example plants

OK Foods of Fort Smith, Arkansas (USA). They produce 318 tonnes of meat per week.

Reference literature

[133, Vizzier-Thaxton et al. 2010], [134, The Poultry Site 2019], [135, COM 2012], [136, McKeegan et al. 2013], [137, EFSA 2014].

3.4.3.1.2 Controlled atmosphere stunning

Description

Inert gases (e.g. argon, nitrogen) are used for stunning/killing chickens and turkeys, whilst they are in their in transport containers or unloaded on a conveyor belt.

Technical description

There are two commonly used CAS systems:

1. The birds are unloaded separately or the drawers with broilers are unloaded on a conveyor belt and then transported through the multistage gas stunner.
2. The birds are stunned in the container/drawer which enters the cabinet, and the gas mixture enters the closed cabinet. The birds are stunned according to a multistage process.

After the multistage gas stunning, the animals are irreversibly stunned and are shackled manually in the slaughter-line.

Mixtures of (a) argon, nitrogen or other inert gases, or any mixture of these gases, in atmospheric air with a maximum 2 % oxygen by volume or (b) any mixture of argon, nitrogen, or other inert gases with atmospheric air and CO₂ provided that the CO₂ concentration does not exceed 30 % by volume and the oxygen concentration does not exceed 2 % by volume can be used.

Achieved environmental benefits

- Reduced dust emissions during unloading, hanging and bleeding. It has also been reported that improved quality and yield have led to reduced by-product destined for disposal as waste. The increase in yield in turn leads to a tendency to store more of the slaughterhouse output in conditions which will not cause spillage or odour problems.
- Reduced energy consumption due to reduced refrigeration time and space requirements, since it is no longer necessary to mature the carcasses. Reduced water use, and consequently waste water production.

Environmental performance and operational data

The specific energy consumption is 3-10 W/kg bird. The specific gas (argon, CO₂ and/or O₂) consumption is 5-20 l/bird [156, TWG 2019].

A reduction in dust levels, from 11.1-29.6 mg/m³ to 9.0 mg/m³, has been reported.

A proprietary system has 12 drawers per module, each with a capacity of around 24 broiler chickens per drawer, giving a total of 288 birds per module. A typical poultry processing line operates at 8 000 birds per hour, thereby killing around 70 000 birds per line, per day.

The system is reported to have the following advantages. It does not impede blood loss; therefore, residual blood in the carcass meat is low. In comparison with electrical stunning, it reduces the number of birds with broken bones and the number of broken bones per bird; this is important as broken wishbones and collarbones frequently cause haemorrhaging in breast fillets and tenderloins. It greatly reduces the incidence of haemorrhaging, not associated with broken bones, in the breast and leg muscles and this improves the yield and the value of products.

Research during 2001 indicated that the adoption of a gas mixture consisting of 80 % by volume nitrogen and 20 % by volume argon is considered to be better than the carbon dioxide-argon mixture from bird welfare and meat quality points of views.

Cross-media effects

The reduced energy consumption, due to reduced refrigeration requirements, may be offset by installations using a nitrogen separation plant for processing atmospheric air.

Technical considerations relevant to applicability

Applicable in poultry slaughterhouses. CAS systems require more space than water bath systems.

Economics

See Table 3.10.

Driving force for implementation

The main driving force is reported to be animal welfare.

Some of the major welfare concerns associated with the water bath electrical stunning systems, which reportedly cause stress, trauma and pain, are removed. These include removing birds from their transport containers; shackling; conveying birds upside down on a shackle line; giving birds an electric shock before being stunned (pre-stun shocks); cutting the necks of birds which miss being stunned adequately, due to wing flapping at the entrance to the water bath stunners and the recovery of consciousness during bleeding due to inadequate stunning and/or an inappropriate neck cutting procedure.

Example plants

Approximately 15-20 % of the poultry slaughterhouses in the EU have a CAS system installed [183, COM 2012].

Reference literature

[66, Raj A.B.M. 2002], [184, IWC 2020].

3.4.3.1.3 Electrical water bath stunning (head only)**Description**

The birds are hung by their feet and only their heads are immersed in the water. An electric current is led to the water.

Technical description

The birds are hung in the shackles of the overhead conveyor by their feet, are led through the bath, in which only their heads are immersed. An electrode is placed which is connected to the control unit is placed in the water bath. The other electrode is formed by a stainless steel shackle guide that touches the shackles which are placed above the bath. In this way, an electric current is led from the electrode to the water, through the head and body of the bird to the feet, from the feet to the shackle.

Achieved environmental benefits

Reduced energy consumption compared to CAS and LAPS systems.

Environmental performance and operational data

The specific energy consumption is 0.1-0.5 W/kg bird. The specific water consumption is 0.05-0.11 l/bird [156, TWG 2019].

Cross-media effects

Dust emissions occur during shackling and stunning of birds.

Technical considerations relevant to applicability

Applicable in poultry slaughterhouses. EFSA has recommended the phasing out of electrical stunning methods on animal welfare grounds [184, IWC 2020].

Economics

See Table 3.10.

Driving force for implementation

No information provided.

Example plants

This technique is widely applied in EU poultry slaughterhouses.

Reference literature

[156, TWG 2019], [184, IWC 2020].

3.4.3.2 Techniques to increase energy efficiency

3.4.3.2.1 Immersion scalding with optimised water flow systems

Description

Use of scalders with optimised water flow systems.

Technical description

Water flow systems in immersion scalding may be optimised through the use of water jets or propellers, as well as through an appropriate shape of the scalding tank and/or the presence of guides. The optimised water flow results in an effective heat transfer to the skin of the animal.

Achieved environmental benefits

- Reduced energy consumption.
- No ammonia emissions are released from the scalding tank.
- Reduced water consumption.

Environmental performance and operational data

Energy savings of up to 30 % are reported, compared to scalding techniques where hot water is agitated by air. For specific models of scalding tanks, an energy consumption of 81 kJ/bird and a water consumption of between 0.2 l/bird and 0.4 l/bird are reported.

Cross-media effects

None.

Technical considerations relevant to applicability

Applicability to existing plants may be restricted by the plant layout/lack of space.

Economics

The investment level and cost of ownership are comparable with other types of scalding solutions.

Driving force for implementation

- Increasing the slaughter capacity or line speed of the plant.
- Replacement of current scalding system because of decreased performance.

Example plants

The technique is applied in several poultry slaughterhouses, in the EU and worldwide.

Reference literature

[182, ORGALIM 2019], [204, TWG 2021].

3.4.3.3 Techniques to reduce water consumption

3.4.3.3.1 Reuse of crate washing water

See also Section 2.3.5.1.2.

Description

Water from the final wash is reused for the early stages. Any large debris is filtered out and top-up water is added to maintain water levels in the system.

Technical description

The system is designed to make the most economical use of water by adding clean water from the final wash to the early stages. Any large debris is filtered out and top-up water is added to maintain water levels in the system.

Crate washing water can also be reused to transport feathers to the offal plant [156, TWG 2019].

Achieved environmental benefits

- Reduced water consumption.
- Reduced detergent use.

Environmental performance and operational data

The crates are removed from their transport container and passed to the bird unloading stage. After emptying, they are washed. The transport container goes to a separate washing system, after which it rejoins the cleaned crate for reloading onto the lorry.

Crate washing is achieved by the use of potable water at ambient temperature. The crate passes through a spray wash section. The water passes over a wire wedge screen and is then returned to a collection bath, for recirculation. A float-operated water make-up system maintains a constant water supply to the system. After leaving the washer, the crate is immersed in a dip tank and travels approximately 6 m, after which it is raised into a final spray washer. The overflow from the washer feeds into the immersion section and also into the first wash.

The last stage is a final rinse using clean water plus a quaternary amine compound detergent/disinfectant. This is added by an automated dosing system at a concentration of 15 mg of chemical per litre of water used.

The transport container passes to an inline spray booth and the water is recirculated via a wire wedge screen to remove large debris. Clean water is added to maintain the water level and this is controlled by a float valve. Detergent/disinfectant is added at a rate of 0.5 l/h.

The clean crates are assembled in the transport containers. Before leaving the system for reloading on the vehicle, they are rinsed again in clean water dosed at a concentration of 15 mg of detergent/disinfectant per litre of water used.

In an example slaughterhouse, the system was installed in a new building. The water consumption increased by an average of 400-450 m³ per 5-day week. This led to an equivalent increase in the amount of water being processed in the WWTP over a 7-day period and the slaughterhouse requiring an increase in its volume consent, from the environmental regulatory authority.

Cross-media effects

Significant increases in water consumption.

Technical considerations relevant to applicability

Applicable in poultry slaughterhouses.

Economics

No information provided.

Driving force for implementation

In an example company, all of the water consumed on a given site is purchased from a local supply company and treated in an on-site WWTP, before being discharged to a river. The discharge volume is set by the regulatory authority. When the live bird handling system was installed, it was necessary to limit the increase in water to enable the installation to operate within the consent limits.

The system was also introduced for bird welfare reasons, i.e. to prevent potential contamination/diseases being transported between farms and factories.

Disinfecting the crates and transport containers reduces the spread of food poisoning organisms between the birds and the human population, which can be carried on the trays.

Example plants

At least one poultry slaughterhouse in the UK.

Reference literature

[84, Rodgers K. 2002], [156, TWG 2019].

3.4.3.3.2 Use of recycled water, e.g. from scalding, for the transfer of feathers

See also Section 2.3.5.1.2.

Technical description

Feathers are collected in a trough under the plucking machine. They are then transported with recirculated water to a screen with water passing through it, before they are collected.

Systems in use in the UK include a water flume system for removing the feathers from the plucking. After the feathers have been screened out, this water is reused in the feather flume. This is topped up with fresh water used during the plucking process. There will be an overflow of water from the scald tank which runs into the feather flume [156, TWG 2019].

Achieved environmental benefits

Reduced water consumption.

Cross-media effects

None.

Technical considerations relevant to applicability

Applicable in all poultry slaughterhouses.

Reference literature

[23, Nordic 2001], [156, TWG 2019].

3.4.3.3.1 Immersion scalding with optimised water flow systems

See Section 3.4.3.2.1.

4 INSTALLATIONS PROCESSING ANIMAL BY-PRODUCTS AND/OR EDIBLE CO-PRODUCTS

4.1 General information for installations processing animal by-products and/or edible co-products

Installations processing animal by-products and/or edible co-products is a term used in this document to refer to the installations other than slaughterhouses covered by the scope of the SA BREF. Installations processing animal by-products and/or edible co-products [114, COM 2019]:

- are included in the scope of the SA BREF under under IED Annex I point 6.5 or 6.4 (b) activities;
- refer to the processing of animal by-products and/or edible co-products, such as rendering and fat melting, feather processing, blood processing, fishmeal and fish oil production, and gelatine manufacturing;
- include other SA activities such as combustion of meat-and-bone meal and of animal fat, incineration of carcasses, anaerobic digestion and composting.

According to the data collection, the majority (around 65 %) of animal by-products and/or edible co-products installations are permitted under IED Annex I point 6.5. Moreover, the vast majority of them have reported a capacity of more than 75 tonnes/day [178, TWG 2020].

The animal by-products industry handles:

- raw materials that are declared not fit for human consumption;
- raw materials that are fit for human consumption, but are not destined for human consumption for commercial reasons.

Both decisions are irreversible. It is not allowed to produce any edible co-products from animal by-products (ABP) [173, EFRA-EAPA 2020]. The permitted use and disposal routes of animal by-products are governed by the ABP Regulation (Regulation (EC) No 1069/2009) [119, EC 2009]. ABP are defined in this EU Regulation as ‘entire bodies or parts of animals, products of animal origin or other products obtained from animals, which are not intended for human consumption. After processing the animal by-products, the products may have several applications, e.g. food and feed, cosmetics, medicinal products and medical devices, technical products, fertilisers and many others.

Edible co-products, also called food-grade products, means products fit for human consumption and destined for human consumption. Therefore all processing steps, i.e. collection, transport, processing and delivery, fall under EU Regulation 853/2004 on hygiene for food of animal origin [174, EC 2004]. All edible co-products must come from ante-mortem inspected healthy animals and must have also passed a post-mortem inspection to be declared fit for human consumption.

Edible co-products can be received from slaughterhouses (blood), cutting plants (fat, bones, rind) and tanneries (split). The main examples of edible co-products are:

- gelatine/collagen;
- blood products like plasma and haemoglobin;
- fat, like lard (pig fat), tallow or beef dripping and poultry fat.

Fats like lard and tallow are mainly a food ingredient for human consumption, while blood products and gelatine are used as functional proteins. Food-grade products can also be used for purposes outside the food chain, like feed for technical applications, e.g. fat in feed or soaps, blood products in feed, or gelatine in pharmaceutical and technical applications like glue or wallpaper [173, EFRA-EAPA 2020].

Products from slaughterhouses like blood or animal fat can be either food-grade products or animal by-products (or non-food-grade products). It is very difficult to distinguish visually between edible co-products and animal by-products. It is therefore important to know what legal status they have, according to the inspection. The processes are in principle very similar, although it should be borne in mind that some food-grade plants cool the raw material transport and storage, which can increase the energy consumption. The hygiene requirements for processing edible co-products are stricter, and thus the consumption of disinfectants and/or chemical agents can be higher than for the processing of ABP.

Table 4.1 shows an overview of relevant animal by-products and the volumes generated per animal.

Table 4.1: Animal by-products (including products intended for human consumption)

Type of ABP	Cattle (kg/animal)	Pigs (kg/animal)
Blood (including food-grade blood)	15-20	3.5-5.0
Paunch and stomach contents	55	0,5
Gut contents	15	2,8
Skin	40	–
Bristles and hoofs/toenails	–	0.4-0.9
Shanks with hooves, horns	11	–
Internal fat tissue	35	1.5
Internal organs	90	10
<i>Source: [181, VDI 2020]</i>		

Installations processing animal by-products and/or edible co-products contribute, by definition, to the circularity of industrial processes, by turning residues and waste into value. Optimisation of streams across the value chain can contribute towards the objectives of circular economy and to the hierarchy of prioritisation for food surplus, by-products and food waste.

4.2 General processes and techniques across installations processing animal by-products and/or edible co-products

4.2.1 Applied processes and techniques across installations processing animal by-products and/or edible co-products

4.2.1.1 Odour treatment in installations processing animal by-products and/or edible co-products

Decomposition commences as soon as the animal is slaughtered. During the period from the time of death to the commencement of ABP processing, temperature in particular affects the rate of decomposition. Much of the material to be processed is wet in nature and this adds to the creation of ideal conditions for rapid putrefaction. Undue delays before ABP processing in conjunction with inadequate temperature control, therefore, have a direct effect on the state of decomposition and on the consequent severity of any odours [60, United Kingdom 2002]. The biological and/or thermal decomposition of raw materials leads to the formation of odour-intensive substances, such as ammonia and amines; sulphur compounds, such as hydrogen sulphide, mercaptans, and other sulphides; saturated and unsaturated low-boiling fatty acids; aldehydes; ketones and other organic compounds. Synergistic effects can increase the odour intensity of the mixture as a whole.

Odour in installations processing animal by-products and/or edible co-products can arise from different sources, e.g. the raw materials, the process, the by-products, or the waste water treatment. Malodorous gases generally include room air from storage of raw material, cooking vapours as a whole and, after the condensation stage, machine air (air from machine, e.g. pressing) and room air from the premises. Many of these installations are required to abate malodorous gases with a control strategy which is installation-specific.

Several factors should be considered prior to selecting treatment possibilities:

- The freshness of raw material, to consider storage or refrigeration before processing, mainly in summer time with high temperatures. The use of fresh raw material can be a problem in terms of reaching suppliers located far from the plant. In the case of long distances, not only would a correct design of the process line with a totally enclosed rendering line be highly recommended, but some previous pretreatment of the raw material to avoid bad smells could also be considered.
- In the separation steps, for example if viscera are separated from skins, bones, etc., the process can be easily optimised in terms of odour streams segregation.
- The volume of raw materials treated is also a variable to consider, because it has an influence on the amount of gases generated.

The separation of high and low odour-concentrated gases is important to facilitate their treatment. Low concentrated gases coming from milling or conveyors can be easily treated compared to gases from cooking, pressing or drying.

The cooker exhaust gas streams (usually treated in thermal oxidisers) are low volumes of very high-intensity odour, often with odour concentrations in the order of million(s) odour units. In configurations where there is no on-site waste water treatment, the cooker exhaust gases may not be passed through condensers to remove the condensable fraction and the whole exhaust stream is fed into the oxidiser for treatment [206, TWG 2022].

The odour intensity of malodorous air streams extracted from areas other than cooker or hydrolyser exhausts (e.g. raw material reception buildings) is lower than that of streams from process exhaust sources but the volume of air is much higher. Biofilters and/or scrubbers in combination are the techniques predominantly used for treating large volumes of less intensely odorous air [206, TWG 2022].

The design for an odour treatment is plant-specific; it should be based on an in-depth analysis of the source and the emission points, considering the possibilities and the limitations of the abatement systems.

In this context, different systems could be applied to reduce odours. Table 4.2 summarises the main techniques to treat odours with their advantages and disadvantages. For example, [169, Pendashteh et al. 2015] suggest the use of absorption methods in a fishmeal and fish oil installation, such as a wet scrubber followed by oxidative scrubber systems which allows a removal efficiency of trimethylamine and trace sulphur compounds of 97 % and 100 %, respectively.

Combustion methods can also be applied. High-temperature combustion can achieve 99 % odour elimination; however, the energy consumption to reach 750 °C for example is important. Another solution can be to apply catalytic combustion using platinum as a catalyser. The temperatures used in catalytic oxidation are much lower (350-400 °C) than in high-temperature combustion. Catalytic oxidation can be applied for installations with low hydrocarbon concentrations in waste gases, but the cost of the catalyst process is also relatively high. For plants with less odour problems, mainly due to location, volume processed, etc., adsorption by active carbon can be considered, but the price of active carbon can be relevant.

Biological systems for odour treatment are being applied. These biofilters or bioscrubbers should guarantee microorganism maintenance since they absorb the problematic odour compounds of the treated gases and allow their biological decomposition. The low cost and simple technology are the main advantages of these systems, which, however, may present difficulties for treating highly polluted streams or due to their considerable demand for space.

Table 4.2: Main techniques for odour treatment in installations processing animal by-products and/or edible co-products

Technology	Advantages	Disadvantages
Absorption	<ul style="list-style-type: none"> - Low CAPEX - Low OPEX - Treatment of highly odorous gases 	<ul style="list-style-type: none"> - Sometimes further purification steps are necessary - Possible corrosion in installations
Adsorption	<ul style="list-style-type: none"> - Recovery of adsorbed compounds - Useful in lightly contaminated streams 	<ul style="list-style-type: none"> - Adsorbent regeneration - Possible secondary emissions
Catalytic combustion	<ul style="list-style-type: none"> - High effectiveness - Possibility to eliminate gases with a broad range of odour compounds - Useful for highly and less polluted gases 	<ul style="list-style-type: none"> - High operating costs - High energy consumption
Thermal combustion	<ul style="list-style-type: none"> - High effectiveness - Useful for highly polluted gases 	<ul style="list-style-type: none"> - High energy demand - High CAPEX
Biological treatment	<ul style="list-style-type: none"> - Low CAPEX - Low OPEX - Useful for less polluted gases 	<ul style="list-style-type: none"> - Components should be biodegradable - Large surface area for installation - Problems with biomass generated

Source: [167, Spain 2020]

4.2.1.1.1 Approach to assessing odour characteristics – sensorial analysis procedure

An approach to assess the odour characteristics is being followed in Belgium (Flanders), which involves assessing undiluted samples against the following parameters:

- intensity;
- (un)pleasantness;
- annoyance.

A sensorial analysis is performed on the collected air, water or product samples in an odour-free and ventilated room. The goal of this analysis is to obtain a qualitative odour evaluation based on the above three parameters. The evaluation of these parameters is done using the scores presented in Table 4.3 and the results are plotted in a colour-coded chart. The members of the panel are also asked to describe the odour characteristics in their own words.

Table 4.3: Scores used for assessing the odour characteristics

Intensity	(Un)pleasantness	Annoyance
Not perceivable (0)	Neutral to pleasant (0)	Not annoying (0)
Weak, faint (1)	Slightly unpleasant (-1)	Slightly annoying (1)
Moderate (2)	Unpleasant (-2)	Annoying (2)
Clear (3)	Very unpleasant (-3)	Very annoying (3)
Strong (4)	Extremely unpleasant (-4)	-
Overwhelming (5)	-	-

Source: [207, TWG 2023]

The sensorial analysis is ideally performed on the same day as the sampling, with a maximum of 24 hours between sampling and analysis. After longer periods, some compounds may react or diffuse through the sample bag which may change the odour character. At least six people perform the analysis to get a more representative average assessment.

The application of this approach is illustrated by the following four examples from rendering installations:

- well-performing water scrubber and biofilter;
- insufficiently performing water scrubber and biofilter;
- well-performing thermal oxidation;
- insufficiently performing thermal oxidation.

1. Well-performing water scrubber and biofilter

In Table 4.4 some information on the samples taken is presented. The results of the approach for determining the odour characteristics are presented in Figure 4.1.

Table 4.4: Odour information for the samples taken in a well-performing water scrubber/biofilter treatment system

Sample location	Odour concentration (ouE/m³)	Odour description	Abatement efficiency (%)
IN scrubber	26 822	Offal, rotten, rendering	-
OUT biofilter	1 232	Forest soil, bark/wood, compost	95.4

Source: [207, TWG 2023]

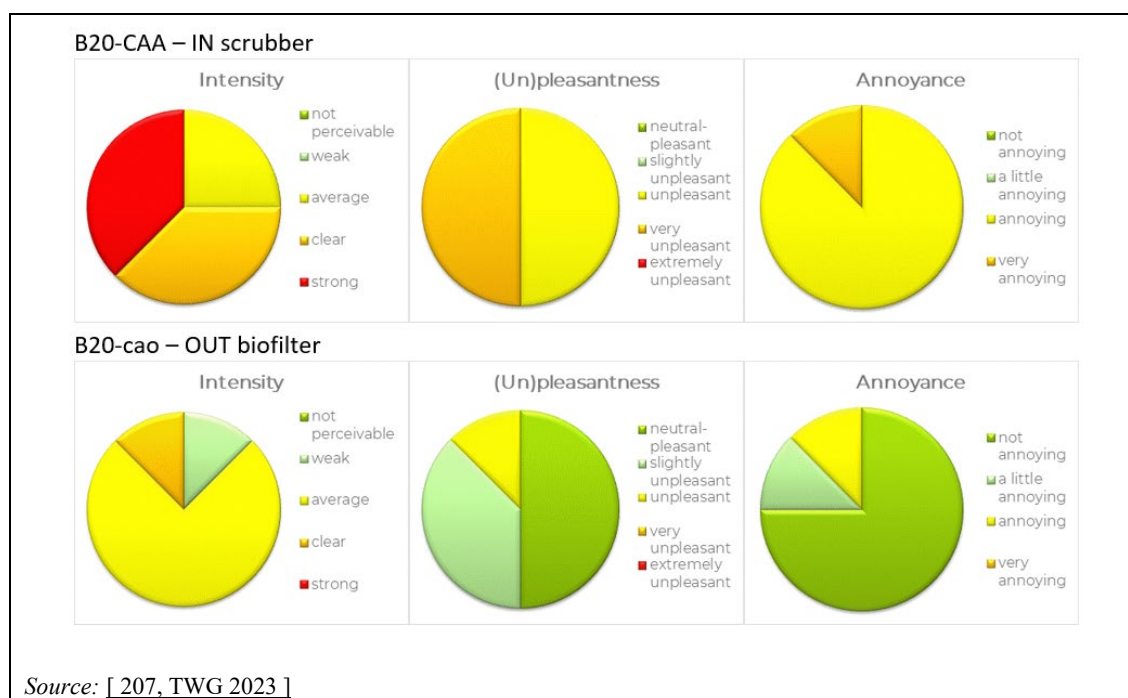

Figure 4.1: Odour characteristics in a well-performing water scrubber/biofilter treatment system

2. Insufficiently performing water scrubber and biofilter

In Table 4.5 some information on the samples taken is presented. The results of the approach for determining the odour characteristics are presented in Figure 4.2.

Table 4.5: Odour information for the samples taken in a insufficiently performing water scrubber/biofilter treatment system

Sample location	Odour concentration (ouE/m ³)	Odour description	Abatement efficiency (%)
IN scrubber	299 680	Fat, rotten, offal	-
OUT biofilter	9 377	Woody, forest soil, rusty, light cabbage smells (sulphurs)	96.9

Source: [207, TWG 2023]

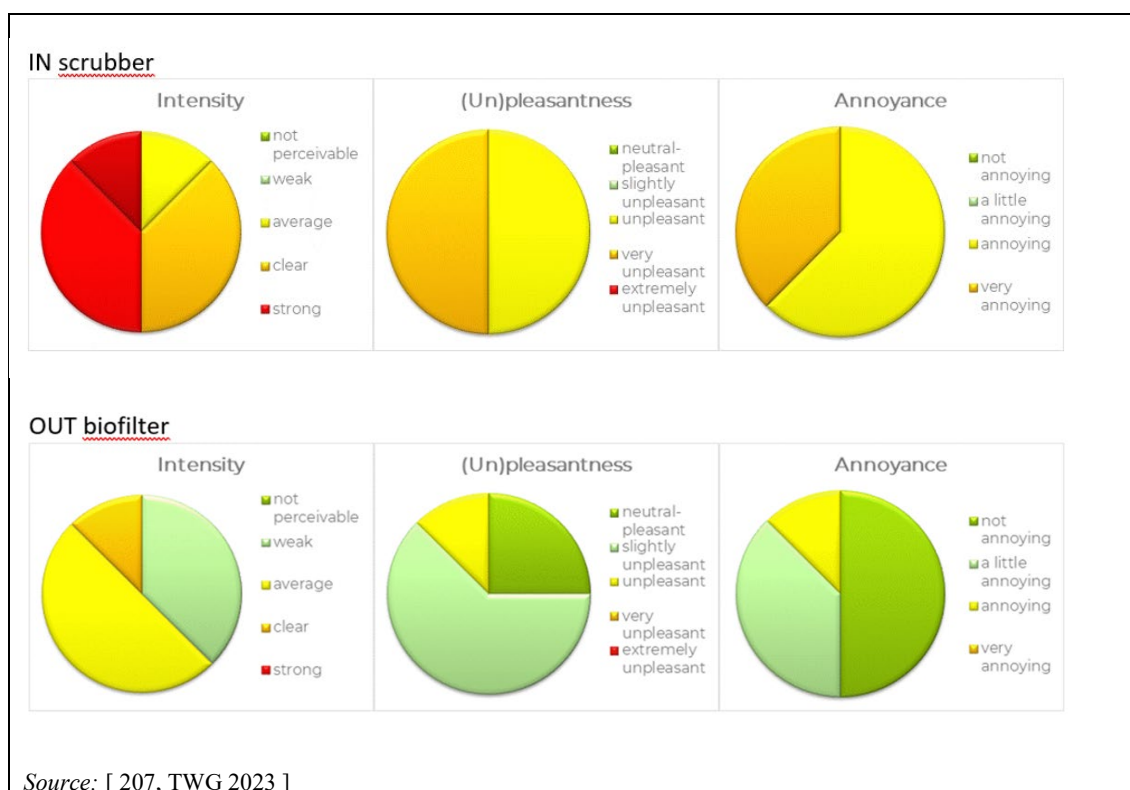

Figure 4.2: Odour characteristics in an insufficiently performing water scrubber/biofilter treatment system

3. Well-performing thermal treatment system

In Table 4.6 some information on the samples taken is presented. The results of the approach for determining the odour characteristics are presented in Figure 4.3.

Table 4.6: Odour information for the samples taken in a well-performing thermal treatment system

Sample location	Odour concentration (ou _E /m ³)	Odour description	Abatement efficiency (%)
IN big flame	16 732 435	Process odour, burned fat, non-condensables	-
OUT big flame	2 988	Gas, prickling, chloride	99.9

Source: [207, TWG 2023]

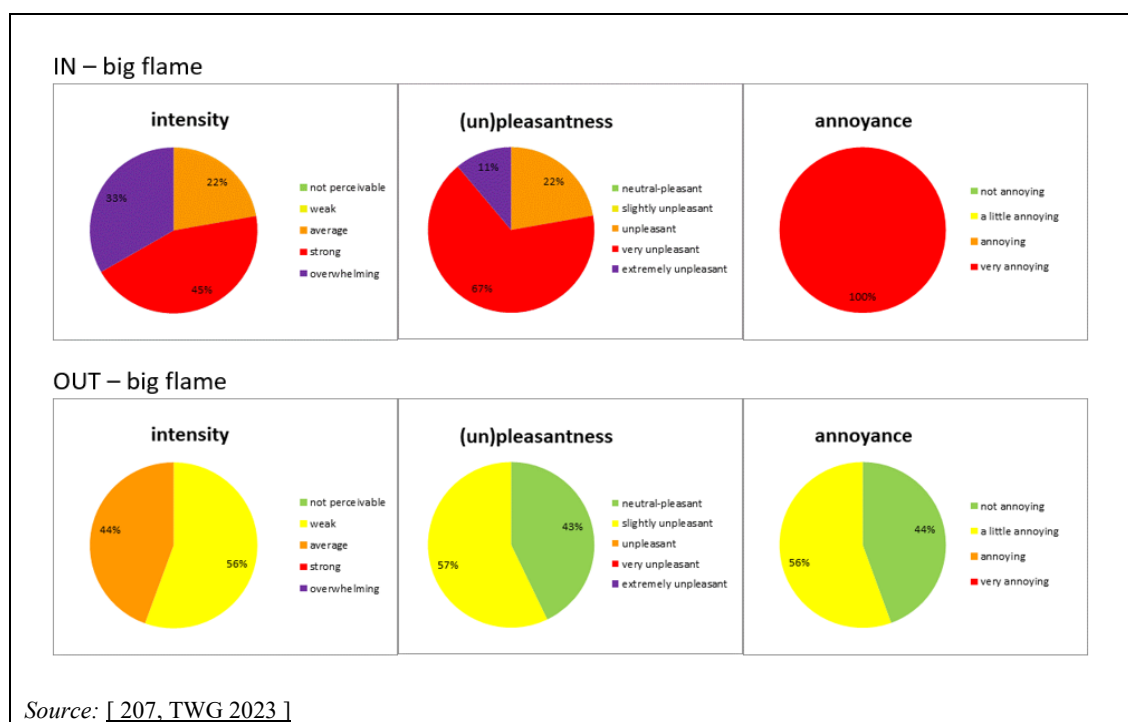

Figure 4.3: Odour characteristics in a well-performing thermal treatment system

4. Insufficiently performing thermal treatment system (temperature 574-606 °C)

In Table 4.7 some information on the samples taken is presented. The results of the approach for determining the odour characteristics are presented in Figure 4.4.

Table 4.7: Odour information for the samples taken in an insufficiently performing thermal treatment system

Sample location	Odour concentration (ou _E /m ³)	Odour description	Abatement efficiency (%)
IN	14 344 393	Burnt fat	-
OUT	85 856	Offal, musty waste smell	99.4

Source: [207, TWG 2023]

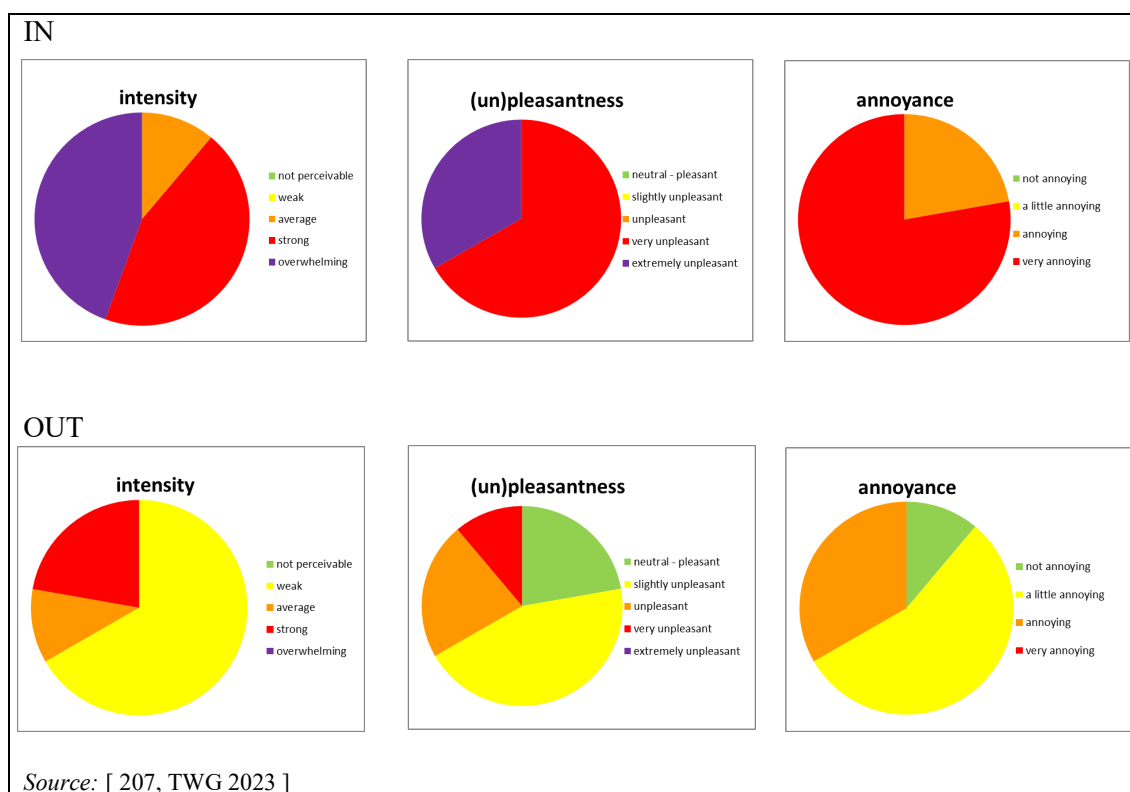

Figure 4.4: Odour characteristics in an insufficiently performing thermal treatment system

4.2.1.2 Combustion of meat-and-bone meal / animal fat

Fats may be used as an alternative to conventional primary energy sources such as fuel oil and natural gas to fuel the steam generator units of the processing plants.

Meat-and-bone meal (MBM) is brown in colour, weighs approximately 600 kg/m^3 and has an intense sweet odour. It is a highly calorific, easily flammable fuel [30, Nottrodt 2001]. The incineration of MBM, in particular has, therefore, developed into a relatively large-scale activity since the use of animal proteins in animal feed was banned.

Commission Regulation (EU) No 2020/735 amending Commission Regulation (EU) No 142/2011 provides rules concerning combustion plants in which MBM is used as a fuel for combustion, including emission limits and monitoring requirements. The emission limits and monitoring requirements applying to combustion plants using poultry manure as a fuel should also apply to combustion plants with a total rated thermal input not exceeding 50 MW using MBM as a fuel in order to meet the relevant environmental standards [188, COM 2020].

In more detail, the following rules are in place [207, TWG 2023]:

Stationary internal combustion engines

Chapter V of Annex III to Commission Regulation (EU) No 142/2011 (as amended) covers types of plants and fuels that may be used for combustion and specific requirements for particular types of plants. This includes combustion of animal fat as a fuel in a stationary internal combustion engine.

Thermal boiler processes

Chapter IV of Annex IV to Commission Regulation (EU) No 142/2011 (as amended) – Alternative Process Methods includes the combustion of animal fat in a thermal boiler process.

The fat fraction must be separated from the protein and, in the case of fat from ruminant origin which is intended to be combusted in another plant, insoluble impurities in excess of 0.15 % by

weight must be removed. The fat must then be vaporised in a steam-raising boiler and combusted at a temperature of at least 1 100 °C for at least 0.2 seconds or processed using equivalent process parameters as authorised.

Description of animal meal

Animal meal can be combusted on the rendering site where it is produced, it can be sent directly from the rendering plant to the incinerator, or it may be kept in an intermediate store. It may be in the form of true meal, i.e. finely ground. In most cases, however, the grinding stage which would have been undertaken during animal feed preparation will have been omitted. Normally it will comprise lumps of up to 50 mm down to dust and this can cause problems with both handling and combustion. Sometimes MBM is delivered in pellets [30, Nottrodt 2001]. The variability of MBM composition is shown in Table 4.8 and Table 4.9. The variability in supply may affect the combustion process and the emission levels.

Table 4.8: Fat, moisture and ash composition of meat and bone meal

Constituent	Intervention Board Analyses	Other analyses
Fat (%)	10-14	8.4-28.6
Moisture (%)	5-10	1.7-14.3
Ash (%)	25-30	12.8-30.7
NB: Details of raw materials unknown. Source: [14, EA 1998]		

Table 4.9: Composition of meat and bone meal

Substance and source	Units	MBM analysis	MBM sample	MBM sample	MBM sample	MBM Cat 1	MBM Cat 3	Feather meal
		Bavaria	Ireland	Portugal	(¹)	(OTMS)	UK	
Net calorific value	MJ/kg	18.0	15.7	17.8	16.13	19.1	14.4	21.2
Water	%	4.6	18.9	2.2	7.53	4.5	3.3	5.0
Ash	%	22.03	29.4	23.6	31.0	15.0	31.7	2.9
Nitrogen	%	7.65	5.8	10.6	7.3	9.0	6.2	13.2
Sulphur total	%	0.62	0.5	0.4	0.33	0.57	0.32	2.5
Hydrogen	%	5.86	7.7	6.9	5.07	6.1	4.4	8.1
Carbon	%	40.83	37.2	47.3	36.3	45.7	32.7	50.8
(¹) Origin unknown. NB: Details of raw materials unknown. Source: [30, Nottrodt 2001], [86, Smith T. 2002]								

Only ground animal meal with a water content of under 5 % and a fat content of under 14 % can be transported pneumatically. There are reports of problems arising with fat contents above 10 %. There is rarely less than 10 % fat in MBM, so pneumatic transport is more practical for lower-fat bone meal and blood meal [30, Nottrodt 2001].

Rotary kiln or fluidised bed furnaces are used for the dedicated combustion of MBM because they can handle the finely divided material. MBM can also be combusted in combined heat and power (CHP) plants.

Tallow may in some cases be incinerated as a support fuel. It burns readily and cleanly and has a very low sulphur content.

Delivery, storage and handling

Animal meal is delivered in bulk tipper lorries or in skips. Tankers can be used for ground animal meal with a water content less than 5 % by weight and a maximum fat content of 10-13 % by weight. It can also be delivered packaged, e.g. in 25 kg or 50 kg sacks [30, Nottrodt 2001]. It is then transferred to an unloading hopper, either mechanically via conveyors/augurs or

pneumatically. This takes place in enclosed buildings to avoid problems of possible wind dispersion of dusty material. The transfer and handling equipment may also be fully enclosed to avoid the spread of dust. Some animal meal will break down and become dusty, whilst that left at the bottom of stockpiles for long periods becomes compacted into large lumps which will have to be broken up sufficiently for handling and effective combustion. Tallow is likely to require heated storage.

Opinions vary about the potential problems associated with the storage of animal meal. The delivery of MBM in quantities which ensure that it is processed and combusted on the day of delivery will minimise storage times and reportedly avoid problems with pests and vermin, spontaneous overheating and combustion and will avoid compaction and hardening over time [30, Nottrodt 2001]. It is reported elsewhere that, unless there is already a specific problem with old or damp animal meal, storage times do not cause a problem [12, Environment Agency 1996].

Gasification of meat and bone meal

MBM has a significant calorific value and one option for combusting it is by gasification to produce 'syngas', which can then be burned or used in methanol production. Heat and/or power can be generated during the process. MBM can be gasified without a support fossil fuel. The following information is largely taken from equipment supply literature [39, Therma CCT 2000] (other sources are cited).

There are optimum MBM characteristics for the gasification process, so the source and pretreatment affect the efficiency of the process. The optimal characteristics are shown in Table 4.10.

Table 4.10: Optimum MBM composition (% mass dry) for gasification and thermal oxidation

Chemical composition	%
Carbohydrate	18
Ash	25
Protein	40
Moisture	3
Fat	14
<i>Source:</i> [130, COM 2005]	

The gasification process involves partial combustion in a reduced oxygen environment. The MBM is fed by a vertical screw conveyor to a ring-shaped combustion chamber, where process room air is added at sub-stoichiometric quantities compared to the fuel load at a temperature of 1 300-1 500 °C. The fuel is recirculated back to the gasifier, in the form of partially carbonised material. Syngas is the product of the low-oxygen combustion process. The syngas has a lower heating value of 4 605 kJ/m³ (NTP) [38, EURA 2000]. The gasification process is endothermic and the syngas is thereby cooled to between 680 °C and 850 °C. The syngas then passes through a cyclone and a heat exchanger to cool it further to 500-550 °C, for combustion in a thermal oxidiser and boiler.

The typical chemical composition of the syngas produced is shown in Table 4.11.

Table 4.11: Typical chemical composition of syngas produced by the gasification of MBM

Chemical composition	%
CO	18-24
H ₂	15-22
CO ₂	10-14
CH ₄	1-4
N ₂	45
<i>Source:</i> [130, COM 2005]	

The syngas can then be burned in a thermal oxidiser or boiler, to produce steam. The combined system can combust MBM; burn air, vapour and non-condensables from rendering; and produce steam. Ash residues containing some carbon are produced [38, EURA 2000].

4.2.1.3 Incineration of carcasses

Incineration is a high-temperature oxidation, which converts materials into gaseous products and solid residues with a high degree of volume reduction. It is possible to incinerate a wide diversity of materials, including a variety of animal by-products.

Rotary kiln or fluidised bed incinerators tend to be used for the incineration of animal by-products. Liquids and finely divided materials are placed within the combustion zone so that they are destroyed after passing through the furnace only once. If a grate furnace is used there is a higher risk of run-out and pooling, especially when carcasses and parts of carcasses are heated, causing fat to liquefy and drip through the openings in the grate. The particle sizes of animal meal may also be small enough for it to fall through the grate openings. A technically and operationally reliable and well-maintained system for conveying material which has passed through the grate back to the combustion zone is therefore a prerequisite for this type of equipment.

Description of animal carcasses and parts of animal carcasses

Carcasses containing up to 70 % moisture and up to 5 % incombustible solids have a heating value of approximately 5 815 kJ/kg [6, EPA 1997]. Other figures, based on a limited experience of large-scale carcass incineration, quote calorific values in the order of 10 000-12 000 kJ/kg for whole carcasses, 11 000-13 000 kJ/kg for quartered meat [3, Environment Agency 1997] and 12 000-15 000 kJ/kg for SRM, comprising skulls, intestines and vertebral columns [64, Sorlini G. 2002].

Animal carcasses are incinerated in fixed hearth incinerators in the UK. Other combustion technologies which have been reported to be suitable include pulsed hearth, rotary kiln and semi-pyrolitic incinerators [12, Environment Agency 1996], [24, Det Norske Veritas 2001]. Promising trials using bubbling fluidised bed incinerators to dispose of crushed animal carcasses have been reported [40, Widell S. 2001]. The incinerators are described below. BFB incinerators are described under Section 4.2.1.2, as the technique is more widely used for incinerating animal meal.

Fixed hearth incinerator

A fixed hearth incinerator operates as follows. A ram loader pushes the carcasses into a primary chamber where they are over-fired with primary air and/or with burners, depending on whether combustion is self-sustaining. Proper mixing of the material on the hearth can be difficult and requires careful adjustment of the feed and ash removal rates. Achieving constant burnout is difficult. The skill and training of the operator are particularly important.

A secondary chamber with an injection of supplementary fuel and secondary air is essential.

Semi-pyrolitic incinerator

This technology is described more as a control method than as a specific configuration of incineration. A primary chamber operates at less than the stoichiometric air requirement for complete combustion and a secondary chamber operates under excess air conditions. The material is dried, heated and pyrolised in the primary chamber, releasing moisture and volatile components. The gas is driven off and then burned in the secondary chamber, which is supported by a supplementary fuel burner.

This method of combustion is reported to ensure a controlled burn with relatively low releases of both VOCs and CO. Also, the low combustion air flow results in a low entrainment of particulate-borne pollutants.

Stepped hearth incinerator

Stepped hearth incinerators comprise a series of concrete steps, typically three, with embedded air channels. The materials are moved from step to step by a series of rams. The first step is a drying stage, with sub-stoichiometric oxygen conditions, during which most volatile compounds are released and burned above the grate in the combustion chamber. The remaining, less volatile material is pushed onto the next step, where the main combustion takes place. The third step is the burnout stage, before the ash is discharged into a final ash burnout chamber, which incorporates air injection and agitation. Material can take 8 hours to pass through the hearths and a further 8 hours in the burnout chamber. This depends, to an extent, on the feed rate, which will also determine the supplementary fuel requirements.

The steps between the hearths provide good agitation as the waste tumbles down the step; however, this also produces surges of unincinerated material, so good secondary combustion and residence time are important.

Pulsed hearth incinerator

Pulsed hearth incinerators use the pulsed movement of one or more refractory hearths to move the waste and ash through the incinerator. The hearths, which are stepped at each side to form a 'U' shape, are suspended from four external supports. The smooth hearth can handle difficult wastes without the risk of jamming and there are no moving mechanical parts exposed to burning material or hot gases. There may, however, be problems achieving the good burnout of solid wastes [12, Environment Agency 1996].

Rotary kiln incinerator

Incineration in a rotary kiln is normally a two-stage process, which takes place in a primary combustion chamber and a secondary combustion chamber. The kiln is a cylindrical shell lined with a refractory substance. It is inclined downwards from the feed end and rotates slowly about its cylindrical axis. The rotation moves the waste through the kiln with a tumbling action, thus exposing fresh surfaces to heat and oxygen. Structures may be added within the kiln, to aid turbulence and to slow the passage of liquid wastes. The residence time of material incinerated in the kiln can be changed by adjusting its rotational speed.

Rotary kilns can operate at very high temperatures. Careful attention needs to be paid to the rotating kiln and the endplates, to prevent the leakage of gases and unburnt waste. The tumbling of waste may generate fine particles.

Commissioning

Commissioning tests carried out for new plants and existing installations planning to incinerate a different fuel from that for which they are authorised for or would normally incinerate enable checks to be made about whether the desired results are achieved.

Delivery, storage and handling

Unloading, storage and handling can be done in totally enclosed buildings and equipment. There may be a risk of theft of meat which is unfit for human consumption, so security needs to be applied.

Charging the incinerator

For batch processes, carcasses are generally fed into the incinerator intermittently, by front-loader vehicles, ram-feed or manually. Opening of the doors for loading can allow considerable ingress of cold air which may upset combustion conditions and increase emissions. Fans capable of responding to changes in furnace pressure during charging, to avoid the escape of fumes or excess airflows, may therefore be used. Large drops in temperature, e.g. during charging of batch incinerators, can be avoided by using charging systems which incorporate airlocks. Continuously operating incinerators are generally fed from enclosed handling and sometimes pretreatment and charging systems. Control of air and consequently combustion is easier with continuously operating systems.

The incineration process

Residence time in the furnace has to be long enough to ensure good burnout, as measured by the total organic carbon content and it needs to be controllable. The supply of air to different combustion zones also has to be controllable.

With most furnace designs, the minimisation of primary air will minimise both NO_x production and the velocities which lead to the entrainment of particles. An adequate distribution of air and fuel on the bed will prevent the formation of hot zones and thereby reduce the volatilisation of material, which could otherwise lead to the formation of heavy metal oxides and alkali metal salts in the fly ash. Combustion zones may be separate chambers or, as in the case of BFB incinerators, they may simply be areas within the same chamber where primary and secondary air are introduced.

Water cooling of grates may be an alternative to providing excess air in grates to control metal temperatures. This can also improve primary air control and hence combustion.

Ash handling and storage

Enclosed handling systems avoiding the use of brushes or compressed air minimise dust emissions and, therefore, assist compliance with both occupational health and environmental controls.

Cleaning

One rotary kiln incinerator operating continuously and its enclosed equipment upstream of the rotary kiln, i.e. the storage, handling, grinding and charging mechanisms, are cleaned by feeding woodchips through the system periodically, usually before maintenance, and then incinerating them in the incinerator. This incinerator is dedicated to the destruction of SRM comprising cattle heads and vertebral columns.

4.2.1.4 Evaporation

Evaporators are used in several SA installations, e.g. rendering systems, fat melting, fishmeal production, to remove water from liquid mixtures. They usually operate at relatively low temperatures and this prevents scorching of the animal by-product being treated. Removing water by evaporation is an energy-intensive process, and low-pressure evaporators are more efficient at this than open kettles or other systems operating at atmospheric pressure. At 50.7 kPa (0.5 atmospheres), water boils at 81.5 °C. Evaporators can be made to operate at much lower pressures than 50.7 kPa; therefore, vapour just above 100 °C can be used as the heat source for the evaporators [72, Ockerman H.W. and Hansen C.L. 2000].

Figure 4.5 illustrates a single-effect evaporator and a typical method of operation. The condensation of live steam or cooker/dryer vapour in the steam jacket provides the heat source to drive the evaporator. Vapour produced from the liquid being evaporated is condensed by the cool water sprayed into the condenser chamber. Water leaving the condenser flows through a barometric leg into an open tank. The water level in the barometric leg is higher than that in the open tank so it creates a vacuum within the evaporator, approximately equal to 74 mm Hg (9.87 kPa) per metre of water in the barometric leg. A pump may be used in place of the barometric leg to maintain the vacuum. The function of the vacuum pump is to remove non-condensable gases, such as air, from the evaporator.

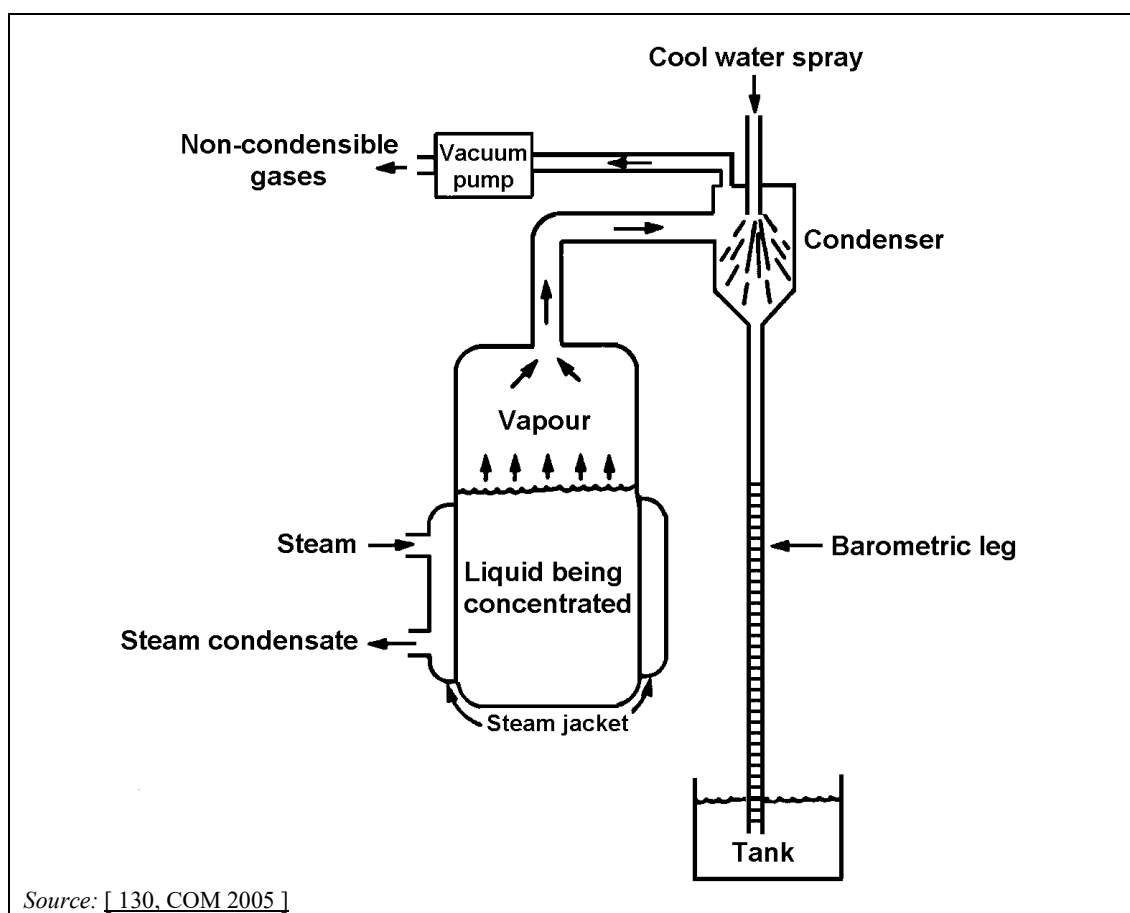

Figure 4.5: Single-effect evaporator

4.2.1.5 Emissions to water

Several installations have no on-site waste water treatment plant (WWTP). These installations either evaporate waste water in the cookers or discharge directly to the sewer or tanker it off site for treatment [160, EFPA 2019].

4.2.2 Current consumption and emission levels across installations processing animal by-products and/or edible co-products

4.2.2.1 Combustion of animal fat

Two boilers (for steam production) are heated by animal fat in a rendering installation in Austria. General information and emissions from the steam boilers are presented in Table 4.12.

Table 4.12: Emissions to air from combustion of animal fat in two steam boilers

Parameter	Steam boiler 1	Steam boiler 2
Rated thermal input (MW)	6.9	6
Start of operation	1993	1975
Fuel	120-695 kg/h animal fat (natural gas for start-up only)	120-590 kg/h animal fat (natural gas for start-up only)
Flue-gas cleaning	No secondary installations for emission reduction	No secondary installations for emission reduction
Flue-gas temperature (°C)	226	257

Parameter	Steam boiler 1		Steam boiler 2	
	Maximum	Average	Maximum	Average
Pollutant (3 half-hour measurements)				
Dust (mg/Nm ³ ; 11 % O ₂)	16	15	18	14
NO _x (mg/Nm ³ ; 11% O ₂)	145	138	147	146
CO (mg/Nm ³ ; 11% O ₂)	< 10	< 10	22	18
SO ₂ (mg/Nm ³ ; 11% O ₂)	< 9	< 9	< 9	< 9
Total C (mg/Nm ³ ; 11% O ₂)	< 5	< 5	< 5	< 5

Source: [113, Waxwender et al. 2016]

Installation AT017 has reported emissions levels from two combustion plants (for steam production) burning animal fat. A minimum value of 166 mg/Nm³ and a maximum one of 297 mg/Nm³ has been reported for NO_x emissions to air. The equivalent values for SO_x emissions are 52 mg/Nm³ and 76 mg/Nm³. No information on a possible O₂ reference level (%) was given [178, TWG 2020].

In installation BE027, animal fat (Category 1) is used as a fuel in three boilers (for steam production). Values of 264 mg/Nm³, 298 mg/Nm³ and 395 mg/Nm³ were reported for NO_x emissions to air. The values for SO_x emissions were 7 mg/Nm³, 8 mg/Nm³ and 13 mg/Nm³. The values refer to a 3 % O₂ reference level [211, TWG 2023].

4.2.3 Techniques to consider in the determination of BAT across installations processing animal by-products and/or edible co-products

4.2.3.1 Techniques to increase energy efficiency

4.2.3.1.1 Multiple-effect evaporators

Description

Multiple-effect evaporators are used to remove water from liquid mixtures generated for example in fat melting, rendering, and fishmeal and fish oil production. Steam is introduced in a series of successive vessels, each one exhibiting a lower temperature and pressure than the previous one.

Technical description

Multiple-effect evaporators are used in, for example, fat melters, rendering systems, fishmeal factories and gelatine plants, to remove water from liquid mixtures. In rendering, raw materials typically contain about 60 % water. Multiple-effect evaporators operate at relatively low temperatures and this prevents scorching of the animal by-products being treated. Removing water by evaporation is an energy-intensive process, and low-pressure evaporators are more efficient at this than open kettles or other systems operating at atmospheric pressure. At 50.7 kPa (0.5 atmospheres), water boils at 81.5 °C. Evaporators can be made to operate at much lower pressures than 50.7 kPa; therefore, vapour just above 100 °C can be used as the heat source for the evaporators.

An effective use of the evaporative heat can be achieved in a multiple-effect evaporator. After the separation of the raw materials into a solid and a liquid phase in a continuous system, by either pressing, centrifugation, or a combination of both, the liquid phase can be dried in a multiple-effect evaporator. The heating medium is the steam generated from the drying of the solid phase and from the evaporation in the other stages of the vacuum dryer. The Atlas process of mechanical dewatering is an example of such a process. The heat consumption in this process is 400-450 kWh/t of raw materials.

Achieved environmental benefits

Reduced energy use for evaporation, i.e. by reuse of the heat from the evaporated water.

Environmental performance and operational data

A multiple-effect evaporator is shown in Figure 4.6. In theory, the efficiency of evaporation can be almost doubled by each doubling of effects, i.e. twice as much liquid can be evaporated per quantity of live steam or vapour consumed in the steam jacket. In a multiple-effect evaporator system, vapour from an effect is condensed in the steam jacket of a succeeding effect. This is possible because the succeeding effect will be operated at a lower pressure and thus a lower temperature.

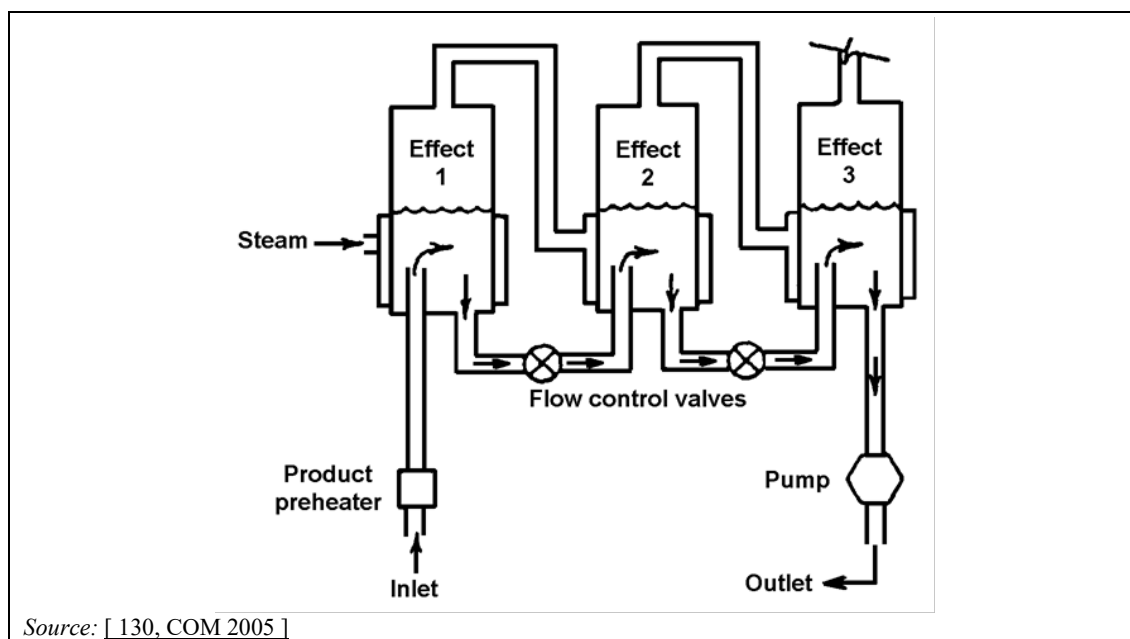

Figure 4.6: Multiple-effect evaporator

The efficiency of evaporators can be improved by providing more heat transfer surface than that given by simply jacketing the boiling chamber. The evaporators often consist of vertical tube bundles with the heating medium on the outside of the tubes and the product boiling on the inside. Product is either moved up through the tubes, i.e. in what is described as a ‘rising film’, or downward through the tubes, in which case the evaporator is called a ‘falling film’ evaporator. The product is fed into these evaporators in such a way and at such a flow rate that it facilitates the formation of a thin film covering the inside of the tubes. This results in high heat transfer coefficients and a tremendous amount of water can be boiled off within a relatively small area of equipment.

Other possibilities are mechanical vapour recompression evaporators, forced circulator evaporators, or combinations of them. The selection of the evaporator type is dependent on the viscosity of the liquid. High-viscosity liquids (e.g. stickwater in fishmeal and fish oil production) should be treated in forced circulator evaporators, which are highly energetically demanding, but if low-viscosity material is treated a falling film evaporator should be enough [167, Spain 2020].

Another sustainable option (from the fishmeal/fish oil industry) for trying to reduce the energetic consumption, and also potentially reduce the carbon footprint linked to this consumption, is to combine the evaporation step with a membrane process as a ‘pre-concentration’ stage. Their use in conjunction with evaporation will allow reduction of the water volume to be treated in the evaporator and also, depending on the membrane and pore size, will increase the water for reuse [167, Spain 2020].

Cross-media effects

None.

Technical considerations relevant to applicability

Generally applicable.

Economics

The capital cost of such continuous installations is reportedly higher than that of conventional systems and they are reported to be only suited to plants with a relatively high level of raw material supplies, i.e. more than 50 000-100 000 tonnes per year.

The use of membrane technology combined with an evaporation step can reduce the operating costs by around 75 % compared with a five-stage multiple-effect evaporator using thermal vapour. [[168, Jevons et al. 2010](#)].

Driving force for implementation

Reduced energy consumption and consequently reduced costs.

Example plants

This technique has been reported in approximately 25 % of installations processing animal by-products and/or edible co-products in the SA data collection [[178, TWG 2020](#)].

Four-stage multiple-effect evaporators are common in onshore fishmeal and fish oil plants in northern Europe [[167, Spain 2020](#)].

Reference literature

[[65, GME 2002](#)], [[72, Ockerman H.W. and Hansen C.L. 2000](#)] [[167, Spain 2020](#)], [[168, Jevons et al. 2010](#)], [[178, TWG 2020](#)].

4.2.3.2 Techniques to reduce emissions to water

4.2.3.2.1 Use of fresh refrigerated raw materials

Description

Raw materials are handled as fresh as possible.

Technical description

If raw materials are handled as fresh as possible, the quantity of compounds that end up in the waste water or the air can be reduced. For example, by cooling warm waste, such as soft waste from the slaughter-line and casing-cleaning department, the formation of air and water pollution can be reduced. Consequently, the energy consumption for waste water and air cleaning is also reduced.

If it is not possible for the processing to take place within the time it takes for odour problems to develop after slaughter or intermediate treatment, materials may be refrigerated. Cooling can take place, if necessary, at the slaughterhouse, in transit or at the animal by-products installation. The refrigeration period may be kept to a minimum, sufficient to simply prevent odour/quality problems without delaying treatment of the animal by-products. Good cooperation between the operators of the slaughterhouse, the haulier and the animal by-products installation minimises the need for refrigeration and the time required, if refrigeration is needed at all.

Achieved environmental benefits

Reduced COD, BOD, sediments, nitrates and phosphates in waste water and reduced odour emissions from storage and processing.

Environmental performance and operational data

It may be appropriate to refrigerate animal by-products due to extreme operational difficulties, such as a long distance between the source of the materials and the installation, which makes quick treatment impossible. An additional or alternative reason may be high ambient temperatures, which cause materials to rapidly decompose and produce malodorous emissions. High temperatures may be seasonal in the north of Europe or permanent in countries with warmer climates.

A British investigation showed that the COD levels in rendering condensate from completely fresh raw materials, raw materials stored in winter and raw materials stored in summer was 2.7 g/l, 10 g/l and 50 g/l, respectively.

A German study comparing waste water contamination in summer and winter illustrates the effect that the storage temperature for raw materials can have on the contamination loads of waste water; see Table 4.13.

Table 4.13: Data for untreated waste water in a rendering plant seasonal differences

Parameter	Maximum (summer)	Minimum (winter)	Annual average values
Quantity of waste water			0.9-1.6 m ³ /t
Temperature			18-35 °C
COD	8-20 kg/t	0.5-3.8 kg/t	3-10 kg/t
BOD ₅	3-12 kg/t	0.3-2.3 kg/t	1.6-5 kg/t
Sediments	1-55 mg/t	≤ 1 mg/t	0.3-8 mg/t
Nitrogen (NH ₄ -N)	1.3-2.7 kg/t	0.1-0.7 kg/t	0.6-1 kg/t
pH value			6-9.7 ⁽¹⁾
AOX ⁽²⁾	25-30 µg/l	< 10-24 µg/l	15-39 µg/l
⁽¹⁾ Range reported over the period of 1 year. ⁽²⁾ At sewage plant outlet, not crude waste water. Source: [203, VDI 1996]			

Cross-media effects

Increased energy consumption if refrigeration is necessary.

Technical considerations relevant to applicability

Applicable in all animal by-products installations where there is a risk of odour emissions which are likely to cause offence and that cannot be prevented without the use of refrigeration.

Economics

The investment cost for a cooling well is reported to be between around GBP 7 000 and GBP 9 000 (2014 values) [211, TWG 2023].

Driving force for implementation

By-products companies charge more for degraded and malodorous materials, partly due to the additional environmental costs associated with odour control and waste water treatment and partly due to the fact that they have no value and have to be disposed of. This therefore provides the incentive for the slaughterhouse to keep the storage of by-products to as short a time as possible and even where further treatment is not possible, but before degradation and the formation of malodorous substances occurs, to refrigerate them.

Example plants

Six rendering plants in Germany.

Reference literature

[23, Nordic 2001], [62, Germany 2002], [75, Woodgate S. 2002], [211, TWG 2023].

4.2.3.3 Techniques to reduce emissions to air

4.2.3.3.1 Enclosure of animal by-products and/or edible co-products during transport, reception, loading/unloading and storage

See also Section 2.3.8.2.6.

Description

Loading/unloading and reception areas are situated in enclosed ventilated buildings. Appropriate equipment is used for transport and storage of the animal by-products and/or edible co-products.

Technical description

Unloading, storage and handling can be undertaken in totally enclosed equipment and in buildings with lockable, self-closing doors, which can be insect-, rodent- and bird-proof. The building can incorporate extraction fans through filters to minimise local odour problems. Material can be delivered in bulk tipper lorries and transferred directly to an unloading hopper, within an enclosed area. Extracted air is usually treated by an odour abatement system.

Hoppers can provide a storage method, which is relatively easy to control and may be combined with automated, fully enclosed, transfer and handling equipment. Material can be delivered in, for example, bulk tipper lorries and transferred directly to an unloading hopper, either mechanically via conveyors/augers or pneumatically.

Achieved environmental benefits

Reduction of odour emissions. A reduction in the risk of the spreading of potential biohazards by insects, rodents and birds.

Environmental performance and operational data

Some animal meal will break down and become dusty, but that left at the bottom of stockpiles for long periods can become compacted into large lumps which will have to be broken up sufficiently for handling and for effective combustion.

Cross-media effects

None.

Technical considerations relevant to applicability

May not be applicable to existing plants due to lack of space.

Economics

No information provided.

Driving force for implementation

Environmental regulator permits.

Example plants

Various installations.

Reference literature

[14, EA 1998].

4.2.3.3.2 Maintenance of negative pressure in storage, handling and processing areas

Description

Materials are stored in hoppers or on open floors in buildings which are well sealed and kept under a slight negative pressure.

Technical description

Material can be stored in hoppers or on open floors in buildings which are well sealed and kept under a slight negative pressure, whilst ensuring that the air is changed sufficiently frequently for the health and welfare of personnel. Storage times can also be kept to a minimum.

The process building can be subdivided internally into functional areas, by using full-height, solid walls, to control and manage air movement. All buildings can be designed and constructed so that they are well sealed to separate different processing areas, such as the raw material reception, storage, cooling and end product storage areas. The ventilation provided can be capable of maintaining negative pressure and preventing an uncontrolled escape of malodorous air to outdoors. The areas from which ventilation is provided can be connected to a suitable odour abatement plant.

Achieved environmental benefits

Reduced odour emissions.

Environmental performance and operational data

No information provided.

Cross-media effects

Energy is used to move large volumes of air. There may be cross-media effects associated with the odour abatement plant.

Technical considerations relevant to applicability

Applicable in animal by-products installations where malodorous animal by-products are handled.

Economics

No information provided.

Driving force for implementation

Prevention of odour emissions beyond the site boundary.

Example plants

A rendering plant and a fat melting plant in the UK. Two animal carcass incinerators in Italy. A slaughterhouse and several rendering plants in Germany.

Reference literature

[7, DoE SO and WO 1997], [30, Nottrodt 2001], [60, United Kingdom 2002], [64, Sorlini G. 2002].

4.2.3.3.3 Use of fresh refrigerated raw materials

See Section 4.2.3.2.1 and also Section 2.3.2.6.

4.3 Rendering of animal by-products and/or edible co-products (rendering, fat melting, blood and/or feather processing)

4.3.1 General information

European renderers turn animal by-products (ABP) and/or edible co-products from slaughterhouses and farms into different products, according to the risk they pose. Around 12 million tonnes of material/year posing a low risk (animal parts not used for human consumption generated in slaughterhouses) are processed into edible fats, animal feed, pet food, oleochemicals and fertiliser [115, EFPRA 2019].

The raw materials are categorised in three different risk categories [205, EFPRA 2022]:

- Category 1 contains material that is not destroyed by commonly known processes like rendering and might harm humans, animals and the environment, like certain medications (including animals which most probably received them like pet, zoo, circus and laboratory animals), SRM (including SRM-containing ruminant fallen stock), environmental contaminants (heavy metals, persistent organic pollutants, etc.) MBM is incinerated or burnt. Fat is used as bioliquid (e.g. in boilers) or to produce biofuels.
- Category 2 contains material that can be safely sterilised but should not enter the feed and food chain anymore, like fallen stock without SRM (for example young calves, fish, pigs and poultry), digestive gut content, etc. MBM is used as fertiliser, and fat is used as bioliquid (e.g. in boilers) or to produce biofuels.
- Category 3 is material from healthy slaughtered animals, safe for use in feed. Fats and processed animal proteins can be used in feed, pet food or fertilisers. Fats are also basic material for the oleochemical industry.

The European Fat Processors and Renderers Association (EFPRA) represents the European animal by-product industry and works on behalf of national associations and rendering companies.

EFPRA's EU members represent 227 processing plants with 410 different processing lines. Plants can run different lines. They do not need to be linked to one line only. Some plants process different categories which are fully separated but use common facilities for treating waste water and odour and for generating energy. It is very common for plants to process different Category 3 materials, for example there is a specialised poultry plant that processes, in different lines, blood, feathers and normal Category 3 materials from poultry slaughterhouses only. In total, there are 65 Category 1 lines in the EFPRA EU Member States, but only 22 Category 2 lines in 10 Member States. Category 3 by-product processing lines process all species and all different kinds of Category 3 material. Some lines are either specialised in processing a certain species, like poultry, pork or ruminant, or in processing certain materials for which a different type of processing is necessary. The techniques for edible or Category 3 products are in general the same, like for fat melting or blood products. However, for hygiene reasons, food- and feed-grade material is never processed in the same line [205, EFPRA 2022].

Table 4.14 gives an overview of the numbers of different lines in the EFPRA EU members.

Table 4.14: Different lines in the EFPRA EU Members

Processing line	Number
Category 1 by-products processing unit	65
Category 2 by-products processing unit	22
Category 3 by-products processing unit (mixed species)	91
Special lines	
Feathers or pig hairs hydrolysis	34

Processing line	Number
Blood meal processing	29
Blood product processing (Food)	4
Blood product processing (Feed)	15
Gelatine bones de-fatting unit	6
Gelatine pig skin de-fatting unit	6
Pure ruminant by-products processing line	2
Pure pig by-products processing line	33
Pure poultry by-products processing line	47
Frozen products unit for pet food	24
Food-grade fat melting unit	22
Feed-grade fat melting line	10
<i>Source: [205, EFPRA 2022]</i>	

In general, all lines produce fat and proteins; only blood and feather/pig bristle lines produce just proteins. Fat melting lines produce mainly fat but also greaves/greaves meal as a second product. Gelatine bone or pig skin de-fatting lines produce mainly fat and proteinaceous pre-products for the gelatine manufacturers.

In 2021, 5.1 million tonnes of Category 1 and 2 materials were processed into MBM and fats. Fats were mainly used as bioliquid in boilers and as a feedstock to produce biodiesel/biofuel. Category 1 MBM is combusted in power stations and cement kilns and Category 2 MBM is used as organic fertiliser. Figure 4.7 shows the different volumes in the different markets [205, EFPRA 2022].

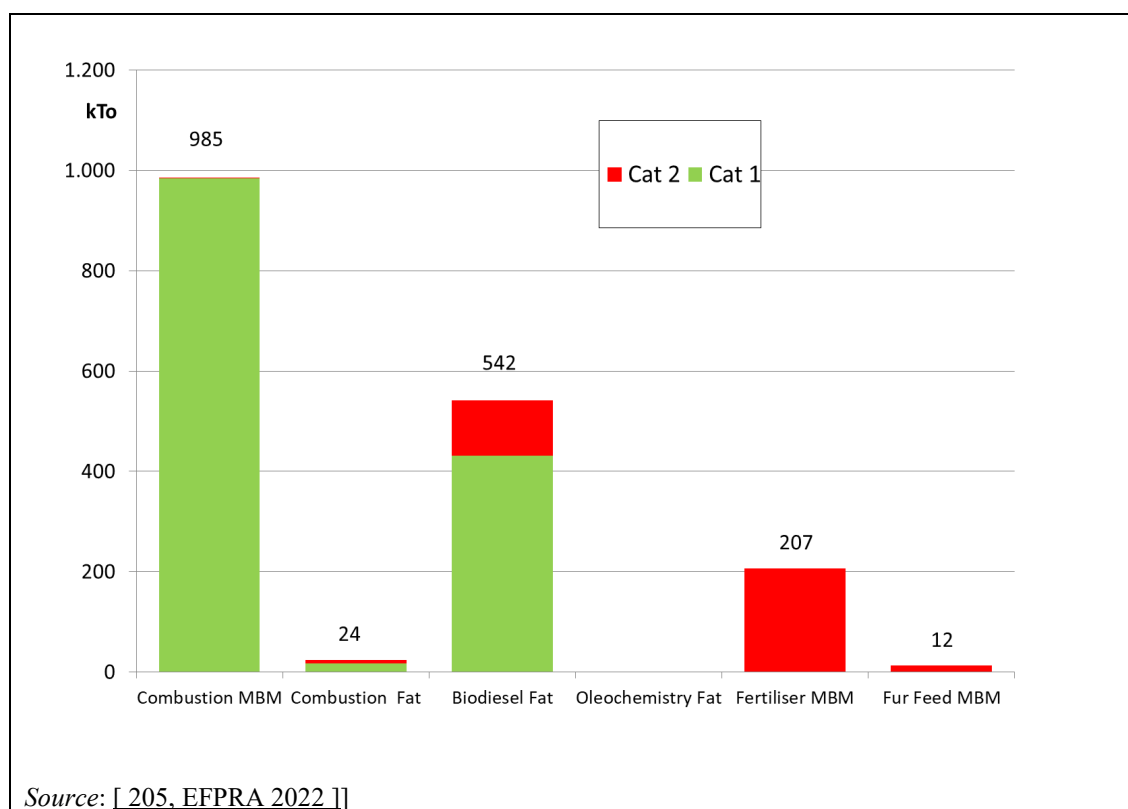

Figure 4.7: Different markets for Category 1 and 2 products

The main Category 3 fat is multispecies fat from mixed species lines (> 40 %). Pig and poultry fats account for about 20 % each. The melted fats lard and tallow represent 17 %. In total, 2.4 million tonnes of fats were produced in 2021. Category 3 fats are mainly sold in four key

markets: biodiesel/biofuels, terrestrial animal feed, oleochemical industry and pet food. Smaller markets include food (only food-grade fats), bioliquids for combustion and feed for aquaculture and fur [205, EFPPRA 2022]. Figure 4.8 shows different markets for Category 3 fats.

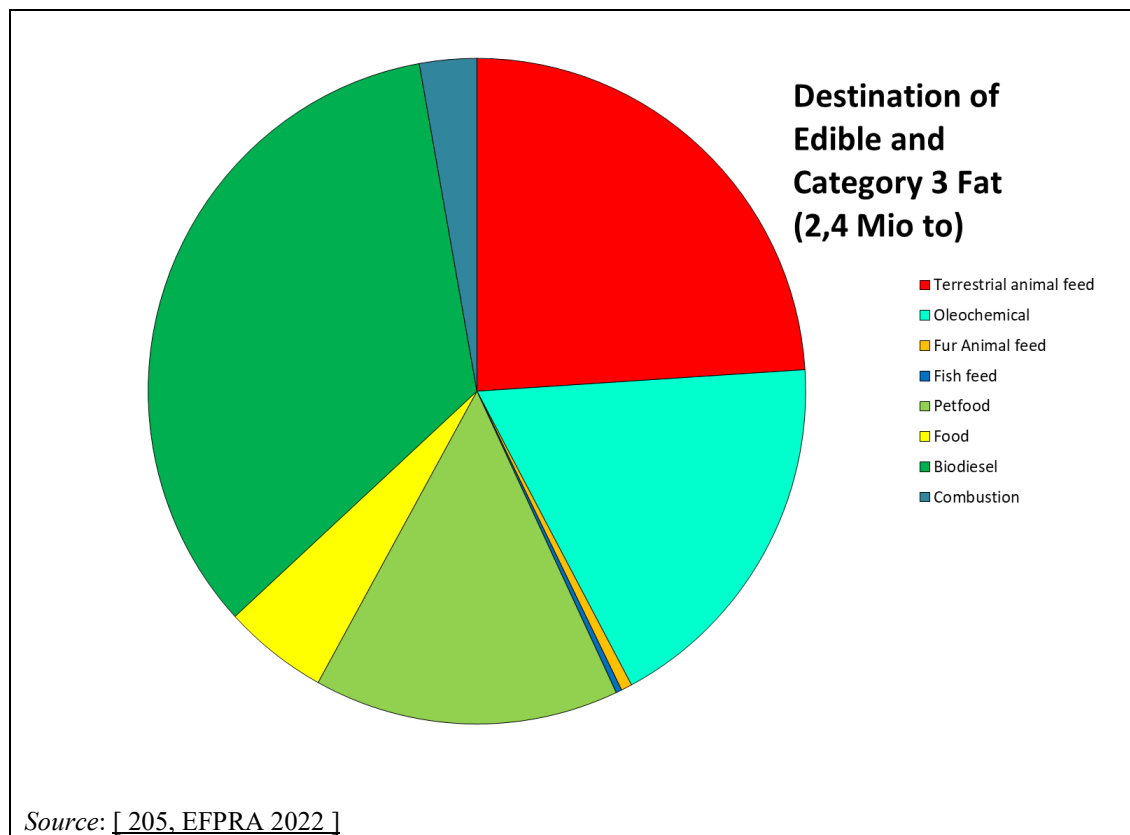

Figure 4.8: Different markets for Category 3 and edible fats

In 2021, EFPPRA members produced 2.85 million tonnes of processed animal proteins (PAPs) and edible proteins. The main products are also multispecies as well as pig and poultry proteins. Proteins from blood, pig bristles and feather processing have only a minor share. PAPs and edible proteins have for many years been mainly used as pet food or fertilisers [205, EFPPRA 2022].

Blood products are processed either under food hygiene regulations or animal by-product regulations. The blood itself must have passed both the ante- and post-mortem inspection of the competent veterinary authority.

Food-grade blood is obtained under strict hygiene rules (Regulation 853/2004) which allow no contamination, only when it is considered fit for human consumption after the post-mortem inspection. The blood is cooled and an anti-coagulant is added [173, EFPPRA-EAPA 2020].

Table 4.15 presents the different blood inspection patterns for different blood uses.

Table 4.15: Different inspection patterns for blood uses

Blood uses	Ante-mortem inspection only	Ante- and post-mortem inspection Blood not fit for human consumption	Ante- and post-mortem inspection Blood fit for human consumption
Blood meal Category 3	+	+	+

Blood uses	Ante-mortem inspection only	Ante- and post-mortem inspection Blood not fit for human consumption	Ante- and post-mortem inspection Blood fit for human consumption
Blood products Category 3	–	+	+
Blood products Food-grade	–	–	+

Source: [173, EFPR-EPAA 2020]

Full blood powder is made from ante- and post-mortem inspected blood. The process is the same as for blood meal production, but the approval of the competent authority is for blood products. The separation of blood products generates two products, i.e. plasma and haemoglobin, as can be seen in Table 4.16.

Table 4.16: Classification of different blood products

Blood category	Type of process	
	Coagulation	Separation
Blood meal / Category 3	+	–
Blood powder / Category 3	+	–
Plasma, Haemoglobin / Category 3	–	+
Food-grade blood products Plasma, Haemoglobin	–	+

Source: [173, EFPR-EPAA 2020]

Data for blood processing lines located in 19 EU Member States, Switzerland and Norway are presented in Table 4.17.

Table 4.17: Data for blood processing lines in EFPR plants

Blood product	Number of lines in 2018	Processed blood in 2018 (tonnes)
Blood meal / Category 3	32	700 000
Blood products / Category 3	11	585 000
Blood products / Food-grade	5	

NB: Blood processing lines located in EFPR members' plants. Data from non-EFPR members (e.g. fat melting lines in slaughterhouses) are excluded from this table. The volumes for edible and non-edible blood products are collected together and cannot be distinguished.
Source: [173, EFPR-EPAA 2020]

4.3.2 Applied processes and techniques

4.3.2.1 General

Rendering is similar in many ways to fat melting and some of the equipment described is identical for both processes. The feedstocks differ and consequently the conditions for separating the fat, water and solids fractions vary accordingly. The raw materials used in rendering are animal by-products which at times can be degraded to some extent, depending on the timeliness of collection and the storage and transit conditions, particularly in warmer weather. This can increase the odour of the material during processing and management and technical measures are usually employed to control odour. Where the water evaporated during rendering is condensed, the condensate has a high organic and nitrogen content and requires waste water treatment [204, TWG 2021].

The rendering process uses animal by-products and/or edible co-products such as carcasses, parts of carcasses, heads, feet, offal, excess fat, excess meat, hides, skins, feathers and bones. These originate from, for example, slaughterhouses, meat processing plants, butcher's shops, supermarkets and livestock rearing facilities. For example, about 10-11 % of a pig is rendered [26, Finnish Environment Institute and Finnish Food and Drink Industries' Federation 2001]. In Germany, an average of 35 % of the live weight of all species is treated by inedible rendering [106, Germany 2003]. The type of raw material in each rendering plant varies. Some plants specialise in individual species, e.g. producing just poultry meal and fats.

Rendering essentially consists of a combination of some of the following processes [160, EFPRA 2019]:

- receipt and handling of raw material;
- sizing of the material;
- phase separation;
- drying/cooking to separate material into separate phases:
 - protein (meat-and-bone meal (MBM) or processed animal protein);
 - fat (tallow);
 - water vapour;
- pressing of the processed animal protein (PAP) and MBM to separate excess tallow;
- filtering and centrifuging the tallow to remove fines;
- milling;
- storage and handling of products and intermediates.

Example process configurations are shown in Figure 4.9 and Figure 4.10.

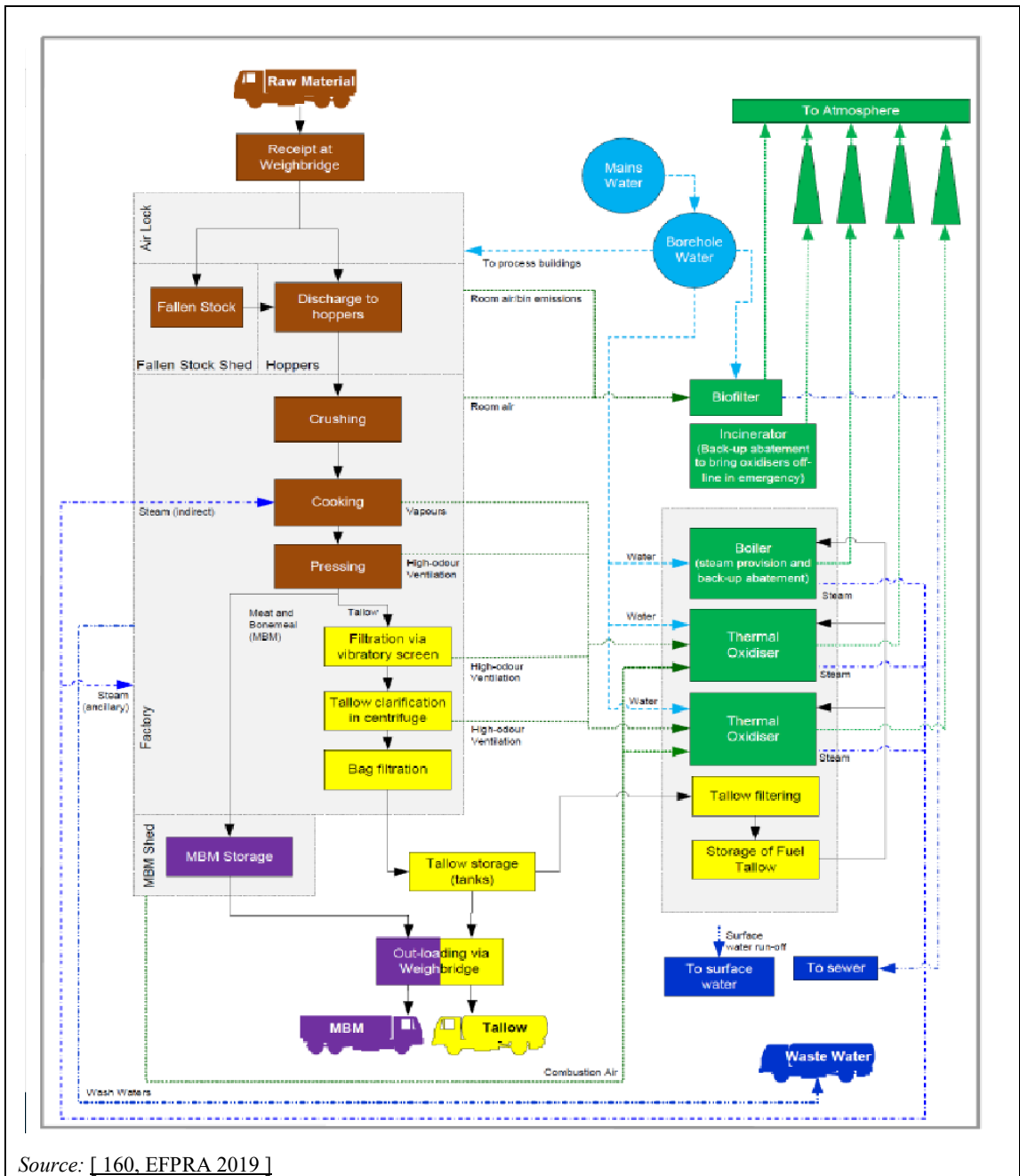

Source: [160, EFPRA 2019]

Figure 4.9: Example of a Category 1 rendering plant flow diagram

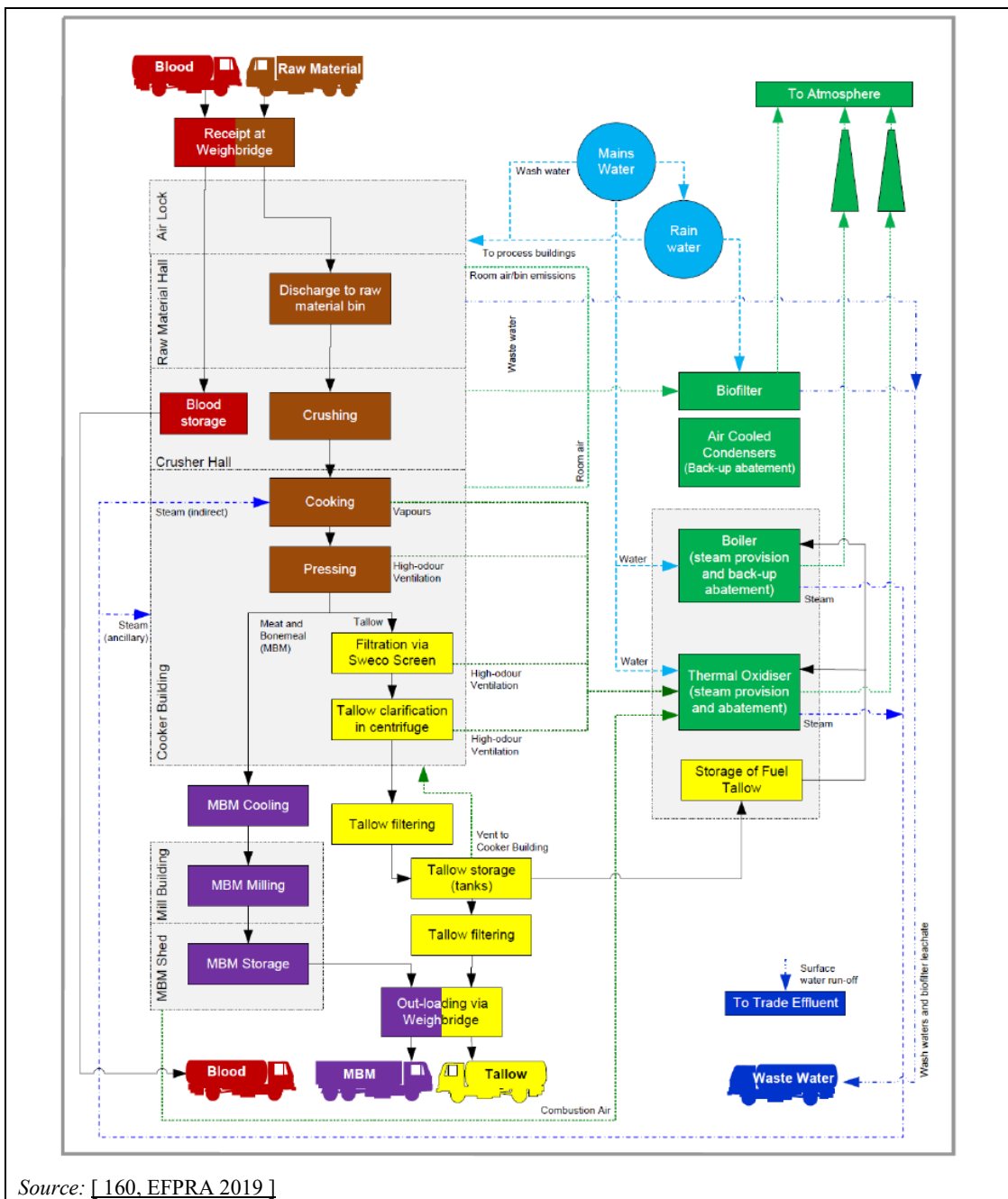

Figure 4.10: Example of a Category 3 rendering plant flow diagram

The rendering processes can be ‘dry’ or ‘wet’. Wet rendering is the removal of the fat phase from wet material (before drying). Dry rendering is the removal of the fat from already dried material.

Chapter III of Annex IV to Commission Regulation (EU) No 142/2011 implementing Regulation (EC) No 1069/2009 (the ABP Regulation) specifies the operating conditions of the processing methods required for rendering animal by-products not intended for human consumption. These vary depending on the risk associated with the materials. The risks are divided into Category 1, 2 or 3 materials, which are defined. The conditions include requirements for the segregation of slaughterhouses from animal by-products processing premises; separation of clean and unclean areas; adequate capacity of specified services and size reduction equipment. It also states general hygiene requirements and details operating conditions, including particle size, temperature, time and pressure [116, COM 2011], [119, EC 2009].

The operating conditions and the sequence of unit operations may vary due to the nature of the raw material or the desired properties of the product, as long as the requirements of the ABP Regulation (Regulation (EC) No 1069/2009) are also met.

The higher the fat-free solids content of the raw material, the larger the quantity of animal meal produced. The more bone in the raw material, the less protein the meal will contain, since bone has a lower protein content than meat or soft offal. If the raw material has a high bone content, the product will have a high mineral content. The average yield of fat and meal from a rendering plant will be about 35-45 % of the quantity of raw material fed into the plant. Examples of some extreme raw material contents include pure meat which can contain up to 75 % water; cleaned bone from a deboning department, which can contain 45 % solid and very fatty material which can contain 95 % fat. Further information can be found in [8, VDI 2008].

The composition of the product to some extent dictates its suitability for further use or disposal. The feedstock can be any part of the animal and may comprise a single substance, such as feathers or blood, or may be a mixture.

4.3.2.2 Raw material reception, handling and tipping

Overview

The freshness of ABP arriving at the site influences the nature and degree of odour associated with the material. Decomposition commences after the slaughter or death of the animal and materials continue to degrade over time, increasing both the offensive odour and the liquid fraction of the material. This is an issue that should be addressed so material is as fresh as possible and easier to handle and process at the rendering facility.

The rules for the chilling of ABP for processing into feed are specified in paragraph 1 of Section 2 of Annex VIII to Commission Regulation (EU) No 142/2011:

1. The transport of animal by-products destined for the production of feed material or raw pet food must take place at an appropriate temperature, in the case of animal by-products from meat and meat products which have been destined for purposes other than human consumption, at a maximum of 7 °C, unless they are used for feeding purposes in accordance with Chapter I of Annex II, in order to avoid any risk to animal or public health.
2. Unprocessed Category 3 material destined for the production of feed material or pet food must be stored and transported chilled, frozen or ensiled, unless it is processed within 24 hours after collection or after the end of storage in chilled or frozen form, if the subsequent transport takes place in means of transport in which the storage temperature is maintained.

As degradation increases, the likelihood of an odour problem increases, and even small odour releases are likely to be noticeable. Highly odorous raw material also puts a greater loading on the odour abatement equipment serving the rendering processing stages. Furthermore, an increase in the liquid fraction will increase pressure on trailer joints and seals and increases the likelihood of leaks and spillages, which can, in turn, lead to odour escape.

Processing material of a similar consistency is important for product quality and for odour control, particularly where abatement technologies other than thermal oxidation are employed. Highly odorous material may overload the abatement system and cause emission of odour. The blending of raw materials of variable moisture content helps to achieve a feedstock of a suitable consistency. The factor influencing the degree of freshness, and therefore the odour potential is the timely collection of the raw material in accordance with the ABP Regulation. The effect of these factors is seen in the different odour potential of different categories of raw material as shown in Table 4.18.

Table 4.18: Contrast between Category 1 or 2 and Category 3 raw material

	Category 1 or 2 raw material	Category 3 raw material
Origin	Can originate from slaughterhouses (SRM material), fallen livestock, dead animals from zoos and other sources.	Mostly ABP from slaughterhouses, meat processors, food manufacturing and retail outlets.
Collection frequency	Collection frequency varies, usually 1-2 days but sometimes up to several days after death of animal.	Regularly collected from the sites of origin.
Control	The renderer has less control over the freshness of the raw material.	Category 3 derived products have more value so raw material freshness is important to maintain the product quality.
Material freshness	Raw material is usually more decomposed and odorous when it arrives at the rendering site.	Raw material is relatively fresh in comparison to some Category 1 materials.

Source: [160, EFPRA 2019]

The main consumption and emissions associated with raw material reception, handling and tipping are listed in Table 4.19.

Table 4.19: Consumption and emissions associated with raw material reception, handling and tipping

Description		Used by / Arising from
Consumption	Water	Cleaning of vehicles, equipment and infrastructure
	Energy	Provision of hot water for cleaning; operation of air extraction and odour abatement systems
	Chemicals	Cleaning
Emission	Odour	Raw material conveyed in vehicles and stored reception buildings
	Waste water	Cleaning of vehicles, equipment and infrastructure

Source: [160, EFPRA 2019]

Refrigeration and freezing

Where chilling is required by the ABP Regulation, this is undertaken either at the slaughterhouse and/or in the transport vehicle, which is refrigerated. This includes high-value products such as offal for raw pet food and blood.

In Mediterranean regions, ABP are occasionally transported in chilled vehicles, even if this is not mandatory under the ABP Regulation. Elsewhere in the cooler EU regions, it is not standard practice to transport ABP in chilled transport unless it is a requirement of the ABP Regulation.

Some of the larger EU pig farms have considered installing refrigerated pits but doing this at all EU farms would be a huge task and would be financially prohibitive in most cases. Similarly, refrigeration of animal by-products at the point of slaughter would also be required to cover the whole supply chain to the rendering facility. This is not standard practice.

Receipt at site

Operators are responsible for ensuring that raw material is processed as quickly as possible and prioritised where necessary. Contingencies should deal with highly odorous material and this may

include exceptional circumstances such as transport delays or difficulties associated with bringing material from geographically remote areas.

Storage awaiting tipping

The aim is always to process material as quickly as possible after arrival at the site and to limit the opportunity for odour egress from trailers and skips up to the point of tipping.

Where space is available, raw material trailers or skips are moved indoors on arrival at the site. When space is not available, they may be parked outside. The following controls are commonly used to minimise odour emissions whilst awaiting tipping:

- trailers and skips remain covered until tipping;
- contingencies are in place to divert material to another site within 24 hours if a delay persists.

Access doors to raw material reception

At many sites, vehicle trailers are driven inside the raw material buildings through fast-acting vehicle access doors, activated by sensors as trailers approach. The doors automatically close a short time after the vehicle passes through. Door sensors can inadvertently open doors if they malfunction or are triggered by other means.

Manual controls for operating vehicle access doors are preferred by some operators who report that automated doors can be problematic, causing odour releases when they malfunction and fail to close. Odour control can be ensured if manual procedures are well managed so that vehicle access doors are kept closed during tipping and at all other times apart from vehicular access.

Personnel access raw material reception areas via dedicated personnel doors which are kept closed between use, either by procedural requirements or by using self-closing devices. It is not common practice for vehicle or personnel access doors to be alarmed if they are left open, when the methods described here are sufficient for door control. Even with good door controls, some air escape is inevitable due to air turbulence caused when a large vehicle passes into or out of a building.

Building airlock arrangements

Some sites have a physical airlock on raw material reception buildings, with a timed delay between the outer and inner doors opening and closing. A controlled ingress of air sweeps through the airlock and is drawn into the extraction ducting to the odour abatement system. Physical airlocks require sufficient space in front of the raw material building and this prevents their installation at some existing sites.

Some sites use an alternative arrangement and have vehicle access doors interlocked with the raw material hopper lids so both cannot be open simultaneously. Air extracted from around or inside the hoppers is fed into an odour abatement system. Where automatic doors are not in place, the opening and closure of manual doors is controlled procedurally.

Another alternative used at some sites is an air curtain across the access door to replace the need for an airlock. At most sites, the extraction of the building air to an odour abatement system minimises the fugitive escape of odours from the buildings.

Tipping location

At most rendering plants, raw material is tipped directly into hoppers. Some plants unload raw materials onto the building floor and then tip them into hoppers using a bucket loader machine. This allows materials to be blended to achieve a consistent feedstock to meet the desired product specifications.

Fallen stock is usually tipped onto the floor, often in a separate reception area, awaiting sampling for TSE controls or skin removal. Occasionally, raw material is tipped onto the floor for physical

inspection of suspect batches to remove foreign objects and prevent physical damage to the processing plant.

Cleaning after tipping

After raw materials are tipped, the trailers or skips are cleaned and disinfected and vehicles are not allowed to leave the site until they have been cleaned and disinfected. Trailer covers are inspected for damage when the vehicles are cleaned.

The building floors are cleaned and any spilt materials are scraped or shovelled back into raw material bins. Trailer, skip and floor washing water runs into internal waste water drains.

4.3.2.3 Raw material processing

Overview

Rendering can be carried out as either a batch or continuous process and there are varying configurations for both. In the EU, continuous cooking is used at all the EU sites where rendering is undertaken on a large scale and batch cooker/steriliser-type systems tend to be used in feather and blood processing plants and for other category materials. Batch processing is also used at smaller-scale rendering facilities at slaughterhouses where the throughput is lower.

The cookers use large amounts of energy to evaporate the moisture from the raw material. Cooker exhaust gases are intensely odorous and must be abated to destroy the odour. This is another very energy-intensive step.

Some sites remove the condensable fraction before thermal oxidation and treat the condensate in a waste water treatment plant. Sites without a waste water treatment plant cannot do this and the uncondensed gases are treated by thermal oxidation or condensate is treated off site.

The cooking room building can become very hot and odorous due to fugitive releases from the presses and cookers if equipment is poorly enclosed. The air from within buildings is often extracted to an odour abatement system. There are seven EU-approved processing methods that can be used to process ABP. These are specified in Table 4.20.

Table 4.20: Processing methods according to Commission Regulation (EU) No 142/2011

Name	Category of ABP	Maximum particle size	Core temperature	Time at core temperature	Special details
Method 1 (pressure sterilisation)	1, 2 and 3	50 mm	133 °C	20 minutes without interruption	Maintain minimum pressure of 3 bar (2 bar above normal atmospheric pressure), by removing all air from the sterilisation chamber and replacing with steam.
Method 2	1, 2 and 3	150 mm	120 °C	50 minutes	Process material in batches, one after another. Do not feed more material into the cooker while one batch is processing.
			and 110 °C	120 minutes	
			and 100 °C	125 minutes	
Method 3	1, 2 and 3	30 mm	120 °C	13 minutes	
			110 °C	55 minutes	
			100 °C	95 minutes	
Method 4	1, 2 and 3	30 mm	130 °C	3 minutes	Add fat before heating
			and 120 °C	8 minutes	

Name	Category of ABP	Maximum particle size	Core temperature	Time at core temperature	Special details
			and 110 °C	13 minutes	
			and 100 °C	16 minutes	
Method 5	1, 2 and 3	20 mm	100 °C	60 minutes	Before processing heat until ABP coagulate (begin to solidify). Then press so that fat and water are removed. Treat the leftover solid material.
			and 80 °C	120 minutes	
Method 6 (for aquatic ABP) preservation method	3	50 mm	90 °C	60 minutes	Mix with formic acid to pH 4.0 or lower and store for 24 hours before further treatment
		or 30 mm	70 °C	60 minutes	
Method 7 – Category 3 only					
Operators can also use other methods to process ABP if the local regulator grants permission. This is known as Method 7. Flexibility in temperature and cooking time is restricted by regulations and varies by customer country. Method 7 is the only way to deviate from these and offers an opportunity to save energy by using lower cooking temperatures and shorter cooking times. However, the method must be validated to prove pathogen destruction.					
NB: For methods where more than one time and temperature combination is required, time spent at the higher temperature also counts towards the lower temperature. For example, in Method 5, the 60 minutes spent at 100 °C count towards the 120 minutes that must be spent at 80 °C.					
<i>Source:</i> [160, EFPRA 2019]					

There is a balance between energy costs, processing time and ensuring the product quality is achieved. The digestible protein content and palatability of meal can vary with the cooking temperature for example. The method can also be chosen based on the feed safety criteria.

Tallow produced from rendered Category 1 and 2 materials must be sterilised (Method 1) if it is to be used for biodiesel production. Tallow for combustion must be sterilised unless it is used on the site where it is made and the import of unsterilised tallow to Europe remains forbidden. The main consumption and emissions associated with raw material processing are listed in Table 4.21.

Table 4.21: Consumption and emissions associated with raw material processing

Description		Used by/arising from
Consumption	Water	Cleaning of equipment and infrastructure, steam supply, cooling towers
	Energy	Used to heat cookers, drive motors, operate building air extraction systems and odour abatement plant, and to heat water for cleaning
	Chemicals	Cleaning, odour abatement
Emission	Air	Combustion plant emissions and odour abatement plant emissions
	Odour	Cooker exhaust gases, separation equipment and process buildings
	Waste water	Cleaning of vehicles and infrastructure, condensate
<i>Source:</i> [160, EFPRA 2019]		

Size reduction

Before it can be processed, any ABP material must be crushed into small pieces with a particle size between 20 mm and 150 mm (the exact size limit is different for each of the approved methods; see Table 4.20). For Method 7, this is specified upon validation.

The raw material is generally fed via screw conveyors or pumped via closed pipes from the hoppers into a mechanical crusher. The material is sometimes passed over a metal detector to remove any metal before entering the crusher.

The equipment used to crush the material may vary, e.g. mincers, cutters or breakers. The equipment is set up to ensure that material larger than the maximum size allowed for the specified processing method cannot pass through. Motors and drives serving this equipment are significant energy users.

Heat processing – cooking or drying

Crushed raw material is fed into the cookers and heated to the specified temperature for the required residence time. This evaporates the moisture and melts the fat. Where pressure sterilisation is required, the pressure is maintained at a minimum of 3 bar by removing all air from the sterilisation chamber and replacing it with steam. This part of the process is conventionally termed cooking but some refer to it as drying.

The cooker design and operating parameters will depend upon whether it is a batch or continuous process and whether pressure sterilisation is included. However, most cookers are heated by steam, fed into a jacket surrounding the material. Other heating methods are used at some sites.

A validated throughput of material per hour is set to ensure compliance with the regulatory method. Some sites use a constant raw material feed rate and vary the steam feed while others use a steady steam rate and vary the raw material feed. The cooker exhaust gases are drawn into ducting leading to the odour abatement system for intense odours.

Separation of cooked material

The cooked material, a mixture of oil (tallow) and solids (meal), is known as greaves. The solid meal material is referred to as meat and bone meal (MBM) for Category 1 and 2 material or processed animal protein (PAP) for Category 3.

The greaves are removed from the cooker via a variable feed screw conveyor and some sites pass them over a metal detector. The oil is drained from the meal in a screw conveyor with a perforated plate screen or through a two-phase decantation and the remaining oil is extracted using presses. Solid material is then pressed and the remaining oil removed. Any spillages or residues are commonly fed back through the cooker. The meal is transferred via screw conveyors to the milling area for further processing. Fine particles remaining in the oil are removed by centrifuge in the oil processing stage (see tallow processing and storage) and/or through gravity sedimentation.

Processing equipment is designed and maintained to contain odours from the handling of hot processed material. Good enclosure of equipment is important and air extraction points are located at essential inspection points and openings to draw odorous air into the odour abatement system.

Meal processing and storage

The meal is hot and odorous when it comes off the presses and is sometimes cooled before it is transported for direct dispatch or to the milling plant. Air cooling and water cooling are commonly used. Some sites cool the meal with building air from the meal dispatch area and then abate odour and dust in this air. Other sites use water jackets on conveyors for cooling.

Where material is stockpiled awaiting milling, it is important to recognise and address the potential for temperature build-up and spontaneous combustion. Thermal imaging and temperature probe monitoring are used at some sites to monitor temperature build-up and material can be spread out to cool if necessary.

Where meal is transported around the site, it is moved in covered containers or trailers to contain dust and odour. In the milling plant, the meal is passed over a metal detector and fed into hammer mills where the cake is broken down into smaller pieces. The material is passed over screens to achieve the desired particle size, followed by homogenisation to finished product specifications.

The product is either packed into bags or screw-fed into silos awaiting distribution. Category 1 and 2 MBM is often stockpiled inside product stores on the floor while awaiting distribution.

Dust from the meal milling operations is contained by enclosure of conveyors and screw feeds or collected in dust arrestors such as bag filters or cyclones. Dusty operations are potential explosion risks and good housekeeping is required to keep dust levels down and explosion risk assessments may be required.

Meal stores and milling areas have the potential to contribute to odour emissions, which need to be contained and may need to be abated.

Tallow processing and storage

Fine particles are removed from the oil/fat using centrifuges (decanter/separators) and/or through gravity sedimentation and the oil/fat is then pumped to bulk storage tanks. Filter aid is sometimes used to achieve a very low solids content.

Most tallow solidifies at ambient temperatures so the storage tanks and road tankers are mostly trace-heated with steam and are controlled to the optimum range using temperature gauges. Tallow is either distributed from the site in road tankers or used as a fuel in the on-site combustion plant.

Spillages of tallow will quickly solidify but could enter nearby drains so tallow tanks are either banded or boarded up or operating and emergency procedures are used to contain and clean up any spillages and prevent them entering the drainage system or damaging the waste water treatment plant.

4.3.2.4 Fat melting

Fat serves in the body as an energy deposit and as isolation under the skin and protects the organs in the abdominal cavity. Raw fat is unique in its composition: fat, protein, water. In contrast to hard tissue like bones, hooves and horns, fat is just weak material, which can be easily downsized and melted. Fat itself is also a known energy/heat carrier which supports the melting of raw fat. Therefore fat melting can be carried out very gently at 80-110 °C. Too high temperatures can degrade the fat in composition and colour [173, EFPR-EEPA 2020].

Fat melting is similar in many ways to rendering and some of the equipment described is identical for both processes. The feedstocks differ and consequently the conditions for separating the fat, water and solids fractions vary accordingly. The product of fat melting is generally for food use, so feedstocks are required to be fresh and consequently cause less odour problems during storage and processing.

Two methods of fat melting have been reported: fat melting with direct steam and fat melting with indirect steam. The method used affects the quality of fat produced. The most important quality demands are: low content of free fatty acids (FFA); low water content; good keeping qualities; low peroxide value; neutral taste, flavour and colour; and high solidification point. Extended storage and processing times adversely affect both quality and environmental standards. Unfresh raw materials may cause odour problems and add to the waste water pollution burden.

Under certain conditions, fat undergoes two important chemical changes, i.e. hydrolysis and oxidation. Hydrolysis is a chemical reaction between fat and water, through which free glycerides and FFAs are formed. The compounds formed during oxidation give the product a rancid taste.

The handling and storage of the raw material before processing and the type of processing carried out determine the FFA and the peroxide value. The FFA content increases with the duration of storage and treatment, especially any time at raised temperatures. To avoid this, the constituents need to be separated quickly. To achieve a low water content, the fat may be purified in a separator. The water content of the fatty raw material normally ranges between 6 % and 25 %.

Sometimes food-grade fat melting plants do not sell the product as edible greaves/greaves meal. It is then considered as Category 3. This does not change the approval as the main product is edible fat. The whole process runs under food hygiene rules and supervision. It is the economic decision of the operator to produce food- or feed-grade greaves.

4.3.2.4.1 Melting with direct steam

After size reduction, the fat tissue is melted with direct steam which is jetted into the raw material. Very often this is done in a continuous process, in a so-called melting tube. A decanter separates the melted material into solids and liquids, which are fats and water. They are separated in a separator. The fat might undergo further cleaning steps. The water is used to wash the solid phase again to remove further fat from the greaves in another decanter. The liquid phase is again separated in a decanter into fat and water. The water goes to the WWTP. The fat is cleaned and stored. The solid part of the decantation is then either sold as wet greaves after cooling (very rare) or dried into a greaves meal. The evaporated water is condensed and goes to the WWTP [173, EFRA-EAPA 2020].

An overview of the process is shown in Figure 4.11.

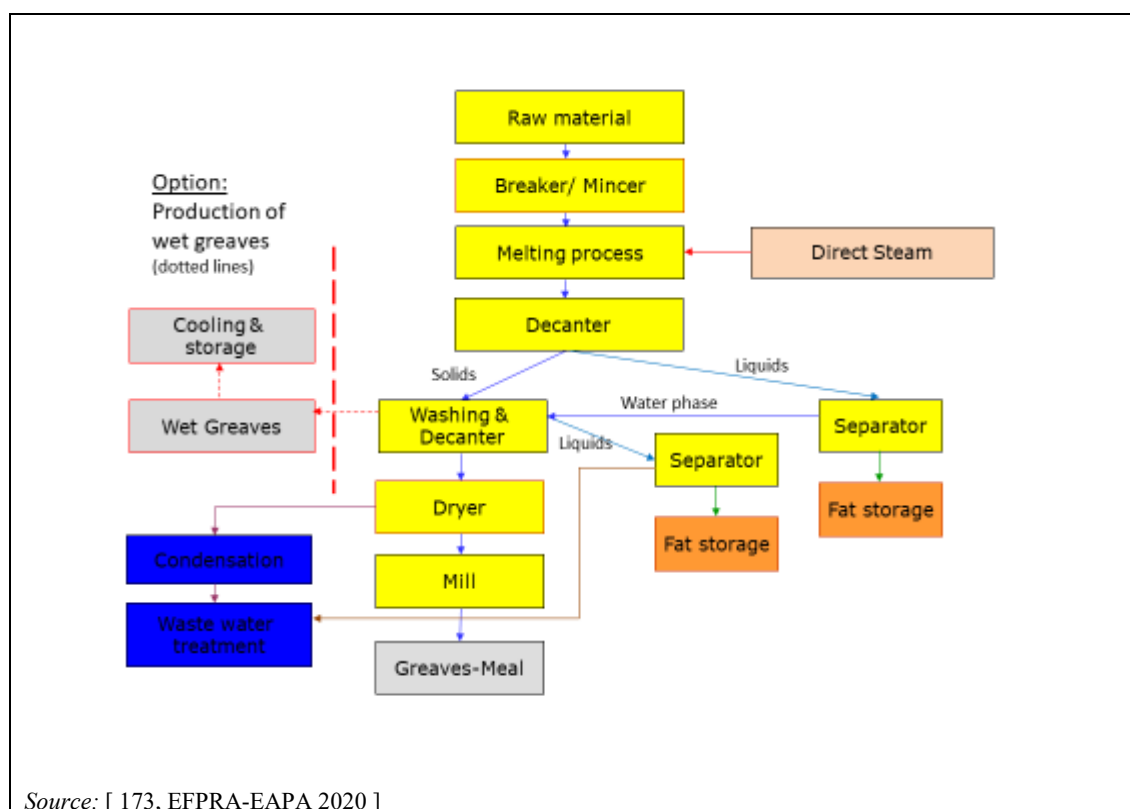

Figure 4.11: Fat melting with the use of direct steam

The direct injection of steam makes the processing time very short, displaces the air and minimises oxidation of the product. It has been reported that there is no rise in the FFA content or peroxide value in fat processed by continuous fat melting with direct steam. Continuous fat melting with direct steam takes less time and space than either batch fat melting with direct steam

or batch fat melting with indirect steam. The fat yield is, however, lower than in the batch method because the effluent water and the greaves contain more of the fat.

4.3.2.4.2 Melting with indirect steam

After size reduction, the fat tissue is melted with indirect steam in a jacketed steam cooker, very often in a batch cooker. Then the fat is separated by a decanter, cleaned and stored. The other phase is dried, the water is evaporated, condensed and sent to the WWTP. The dried solids still contain fat, which is removed in a press. That fat is also cleaned and stored. The remaining press cakes are milled into greaves meal [173, EFPRA-EAPA 2020].

An overview of the process is shown in Figure 4.12.

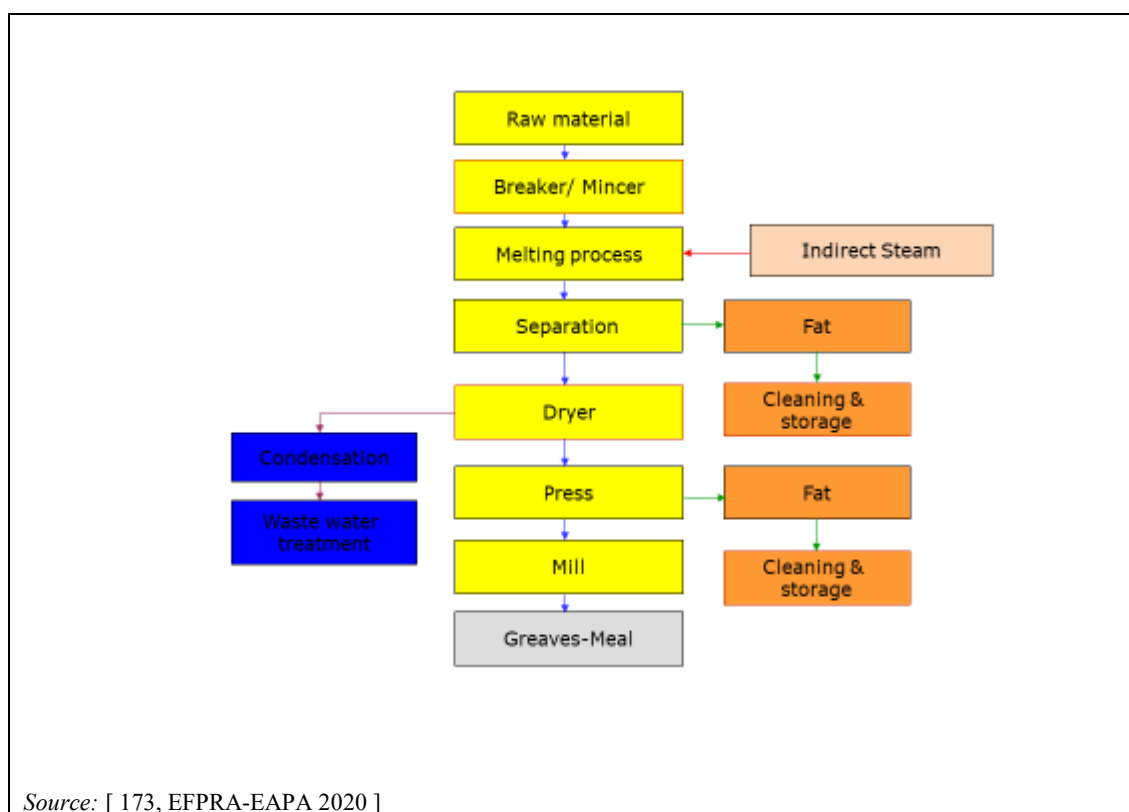

Figure 4.12: Fat melting with the use of indirect steam

The material is agitated during heat treatment and good heat transfer is obtained. It is therefore possible to use lower temperatures than for fat melting with the use of direct steam and to still liberate the fat in one batch within a shorter period of 1.5-2 hours. It is important that the heating process is stopped before all the water is evaporated; otherwise, the product will be discoloured.

Fat melting with the use of indirect steam requires less space and time than wet fat melting with the use of direct steam. Due to the process being dry, the fat yielded will not be equally neutral in taste, flavour, or colour, even if the cooking cycle has been carried out correctly. The slightly roasted taste of the fat is a desirable feature in some countries. Compared to processing with the use of direct steam (wet processing), an advantage is that all of the water is removed by evaporation and there is less waste water contamination, because water is not added to the raw material which would then need to be subsequently removed. The evaporated water will, however, contain some volatile substances released during the drying process. There is a disadvantage, in that certain discolouring elements, which would otherwise have been extracted with the water, now remain in the fat.

4.3.2.5 Blood processing

4.3.2.5.1 Blood processing – blood meal

Blood is a liquid whose dry matter content is dependent on the method of collection at the slaughterhouse, the species and the dosage of anti-oxidants/anti-clotting agents. The dry matter content is 10-12 % for poultry blood and 15-20 % for pigs and cattle blood. That means that 80-90 % of blood is water and has to be removed to receive a dry and stable product.

Blood contains functional proteins like albumin, immunoglobulin or fibrinogen. Those proteins are highly digestible and contain valuable amino acids. Their functionality and digestibility can be degraded or destroyed if the raw material is not properly cooled and treated or when the drying method and conditions are too harsh. The high functionality of the proteins leads to a lot of applications in the meat industry; the immunoglobulin G is specifically relevant for the diets of very young animals. A high digestibility of valuable proteins means a high body retention and therefore a reduced excretion, which protects the environment by not wasting energy and resources. This explains why mild and careful drying techniques are used [173, EFRA-EAPA 2020].

Blood from slaughterhouses is mostly sent to animal by-product processors where it is treated in several ways. Some ABP processors treat blood in the rendering process while others treat blood in a separate plant to either sterilise it for landspreading or to produce a blood meal. Slaughterhouses send blood for processing into food products such as black pudding or it can be spray-dried into pet food or made into plasma/haemoglobin.

Overview

The quality or freshness of blood and feather supplies is important for manufacturing blood and feather meals. Non-fresh material will cause significant odours during processing and handling and will affect the product quality.

Chilling blood at source extends the shelf life and minimises odour potential and blood suppliers often store blood in refrigerated tanks while awaiting collection for specialised uses. For lower-value products, it is not standard practice to chill blood at source and road tankers and bulk storage tanks at the processing site are not refrigerated.

Blood spillages are a risk and relatively common, either at the slaughterhouse during collection or at the processing site during offloading. Process water from feathers or blood water phase is also highly polluting. Failure to contain spillages on site can cause severe water pollution, either directly or by overloading the waste water treatment plant.

Minimising the degradation of blood in storage helps to control odours and product quality. The energy and odour issues associated with blood and feather processing are essentially the same as for rendering.

Receipt and storage

Blood is regularly received from the slaughterhouse, normally at the end of the day's slaughter, and is usually received in covered trailers and the same controls are applied as for raw materials related to rendering.

The blood is usually delivered to the processing site by road tanker, weighed and sent for unloading. The blood tanker is connected to the delivery lines and the blood is filtered into the storage tanks to remove unwanted material such as feathers.

Blood treatment by rendering

Most operators process blood through the rendering lines by feeding it in with other raw materials. Due to the high water content of blood, the energy consumption is high and cooking temperatures can be affected by excess moisture. This is managed by controlling the feed and mixing with other

raw material. Some sites preheat blood in a coagulator to overcome process fouling and this can reduce energy consumption in the cooking stage.

Blood sterilisation

Some operators sterilise blood before transfer off site for further processing or for application to land as fertiliser in accordance with the ABP Regulation. Blood is pumped from the bulk storage tanks, macerated and pumped into a coagulator where heat and pressure are applied to sterilise it.

Blood meal manufacture

An overview of the process is shown in Figure 4.13. Blood is pumped from the storage tanks into a coagulator and steam is injected to split the blood into water phase and solids. The coagulator is not always used as the sterilisation stage and sometimes the blood meal is sterilised and the water phase is sent to the WWTP without an official Method 1-7 sterilisation.

The coagulated blood is fed to a decanter to separate the solids from the water phase. The blood water phase is stored in tanks and fed to the waste water treatment plant or tankered off site for treatment. The solids are conveyed to a dryer and the dried meal (sterilised to comply with the requirements of the ABP Regulation approved method) is cooled, milled and discharged into bags at a bagging station or stored loose in bulk. Dust in the milling and bagging areas is contained in the equipment and with dust arrestors.

The process equipment is fully enclosed and all process waste gases are treated in an odour abatement unit. Despite this, buildings where blood processing is undertaken have the potential to contribute to fugitive odour emissions so the air may need to be extracted to an odour abatement system.

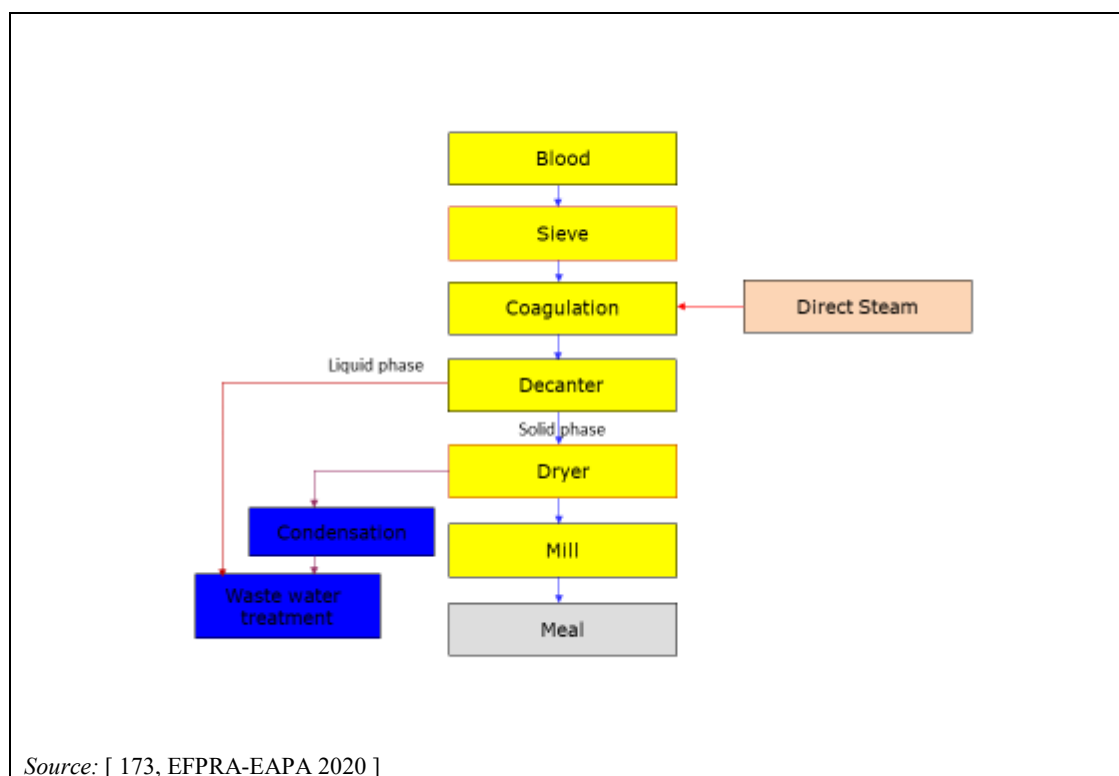

Figure 4.13: Typical process flow for a blood meal plant

4.3.2.5.2 Blood processing - plasma and haemoglobin

This process intends to keep the valuable properties of the two products, the plasma and the haemoglobin. This already begins at the slaughterhouse where the blood's autolysis is reduced by cooling, and the blood's clotting is reduced by adding anti-coagulants.

The blood is controlled on freshness and deterioration upon receipt at the blood processing plant. The process starts with the separation of the solid (containing red cells) and the liquid phase (containing plasma). The haemoglobin is obtained by spray drying after separation. The plasma, which contains most of the water, is concentrated first and then spray-dried. Only very careful drying can minimise the thermal destruction of the plasma and preserve its functionality.

An overview of the process is given in Figure 4.14.

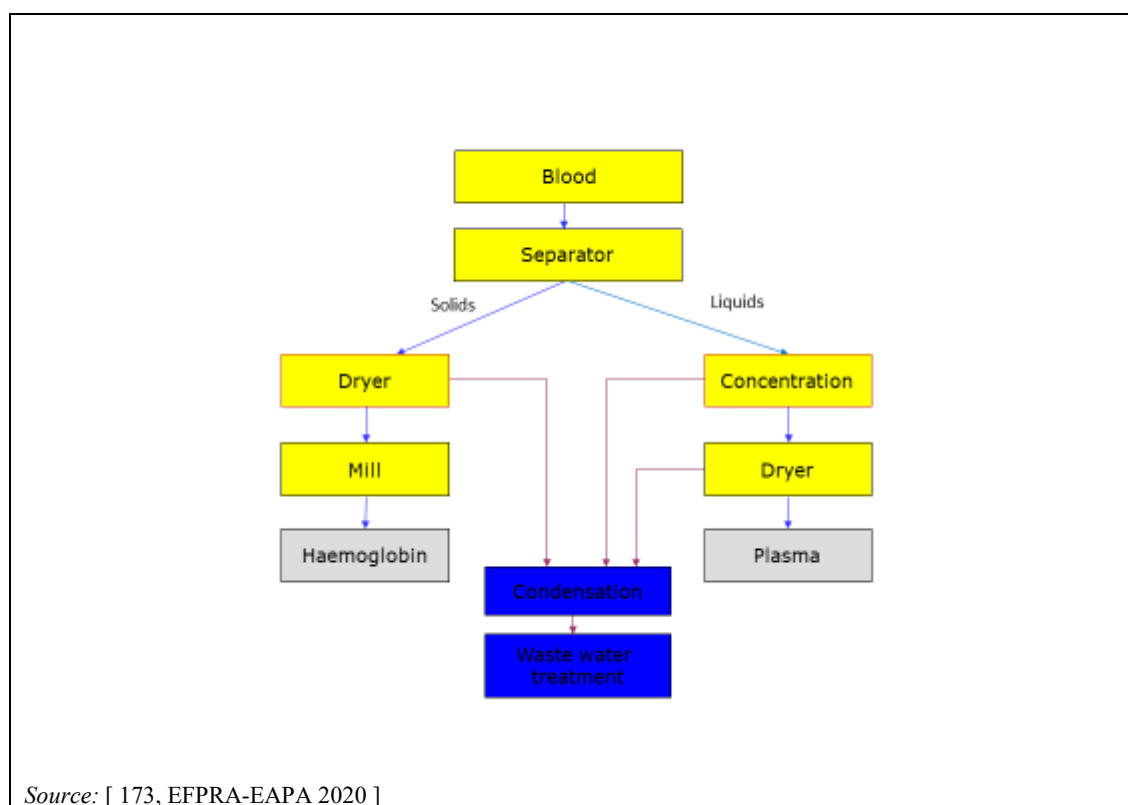

Figure 4.14: Overview of the blood processing to obtain plasma and haemoglobin

Blood collection

At the slaughterhouse, following hoisting, the stunned animal is stuck with a sticking knife at the lower end of the neck. This severs the major blood vessels, including at least one of the carotid arteries and jugular veins. Blood gushes from the stick hole to drain into a tank, canal or collection trough that receives the blood from multiple animals. For the collection of blood for the preparation of spray-dried plasma, it should not be allowed to clot. To prevent this, blood is mixed with a solution of sodium citrate and/or sodium phosphate. Blood can be collected animal by animal but this is generally not practical for large numbers of animals. Thus it is usually pooled at the point of collection.

Filtering and centrifugation

The blood is filtered at the slaughterhouse and at the manufacturing plant. Following filtration, it is centrifuged to separate the plasma from the blood cells. This is done either at the slaughterhouse or at the processing plant. These two processes also assist in removing large particles. If there is infectivity present, it will mostly be in the cellular fraction. Plasma would not necessarily be free

of infectivity but it would be likely to be significantly reduced by separation of the cells. Following centrifugation, there are three further filtration steps. Subsequent equipment is dedicated either to plasma or to cells.

Plasma production

The plasma yield is collected in a refrigerated stainless steel storage tank and chilled to 4 °C. At this point, the plasma from various sources is allowed to mix in the storage tank. One tank may hold the blood from 1 500-8 000 pigs or 350-750 adult cattle. Cattle and pig plasma may be mixed [53, APC Europe 2001].

The plasma received from the slaughterhouse contains approximately 8 % solids. These are removed by reverse osmosis and/or nano-filtration. This also concentrates the plasma, removing water and minerals, as well as the anticoagulant. The filters remove particles down to a 1 nm diameter. The purified plasma is then machine-homogenised and pressurised, in preparation for spray drying.

Alternatively, the plasma may be concentrated by vacuum evaporation. This technique involves the removal of the water from the plasma, under vacuum at < 40 °C.

The spray drying involves the injection of the plasma into a heated drying chamber, at high pressure to form very fine droplets of 10-200 µm diameter, using a high-pressure nozzle. The type of nozzle used depends on the configuration of the drying chamber and on the flow of heated air. The drying chamber is the part of the system where the tiny plasma droplets come into contact with the heated air and hence where the drying process takes place.

When the droplets encounter a stream of heated air, the moisture quickly evaporates to form a dry powder. It is important that the drops are uniformly sized and are produced at a consistent rate, so that all the particles are exposed to the same temperature conditions. Specially designed and engineered nozzles are used to achieve this.

The air circulating through the drying chamber is atmospheric air, finely filtered and warmed by passing through a steam heater or an indirect gas heater. A centrifugal ventilator moves the heated air into the circulation system. The inlet temperature at one installation is reported to be 240 °C. The minimum contact time is 15 seconds at that same installation. It may be up to 30 seconds in other plants. The outlet temperature is 90 °C.

The plasma fraction is then bagged and stored. It has a moisture content of < 10 %. It is used in pet food and piglet feed [41, APC Europe 2001]. Plasma can currently be used by the meat industry, e.g. in cooked ham and cooked sausages and for pet food production [74, Casanellas J. 2002].

The process is illustrated in Figure 4.15.

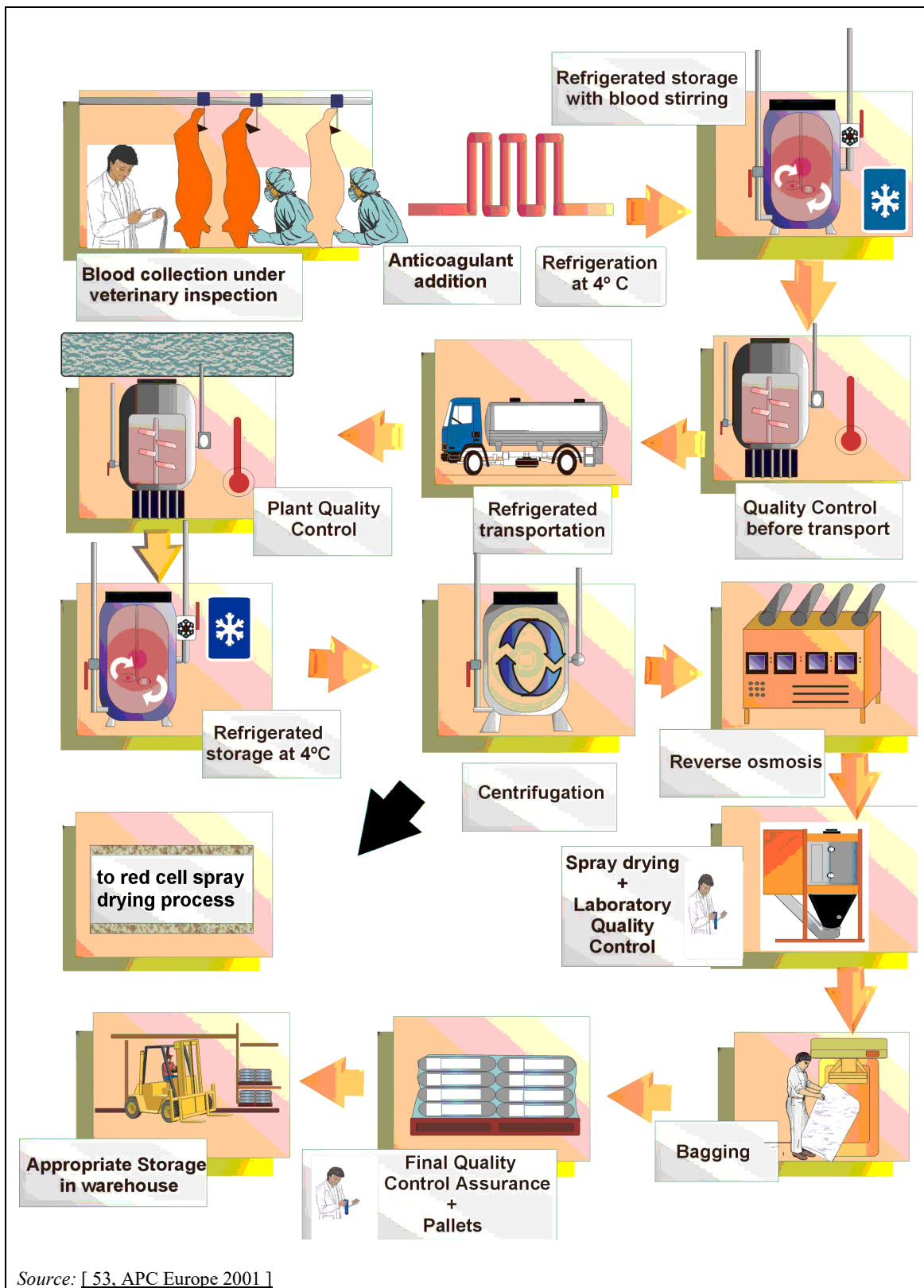

Figure 4.15: Spray-dried plasma manufacturing process

4.3.2.6 Feather processing

Receipt and storage

Feathers and bristles are collected regularly from the slaughterhouse, usually at the end of the day's slaughter. Feathers are usually received in covered trailers and the same controls are applied as for raw materials related to rendering.

Feather and hair/bristle processing

Feathers or hair/bristles are treated separately in a dedicated plant to manufacture a meal product. There are several feather and hair/bristle meal plants in the sector. These materials generally require different process equipment to rendering. The principles are the same, i.e. the application of heat to evaporate moisture and/or a pressure step if required by the ABP Regulation. An example process flow diagram for a feather meal plant is shown in Figure 4.16. Feather and hair/bristles are sometimes processed into hydrolysed proteins in a similar manner.

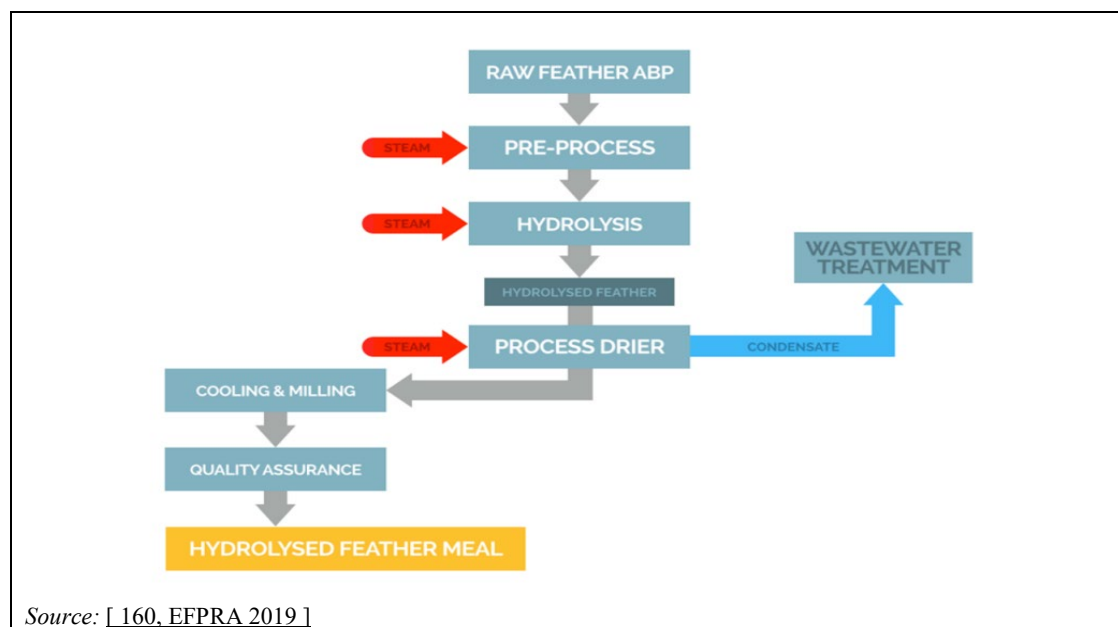

Figure 4.16: Typical process flow for a feather meal plant

Feather and hair/bristle meal manufacture

The raw material handling stages are essentially the same as for rendering. Feathers or hair/bristles are fed from raw material hoppers via conveyors into the hydrolyser which fluidises and hydrolyses them by applying steam and pressure at the regulatory approved method rate. Single-pass hydrolysers provide heating and fluidising of the feather or hair/bristle substrate at elevated temperatures while mixing to effect uniform hydrolysis. The sterilisation can take place in the hydrolysis stage or in the drying stage.

The hydrolysed material is distributed as a feed or fertiliser product for example. Alternatively, it can be further processed by pressing (pressed feathers have approximately 62 % water content) and then drying into meal. The dried material is milled to the desired product specifications before packing or bulk distribution.

Feather water from the press is collected and is either tankered away and injected into land or reprocessed via an evaporative condenser and fed back into the dryer to recover more product. The process equipment is usually fully enclosed and all process waste gases are treated in an odour abatement unit.

4.3.2.7 Production of pulp

It has been reported that some plants are processing carcasses as well as by-products from slaughterhouses for the production of pulp [204, TWG 2021].

The raw material is delivered in closed containers by truck to the plants. The production line consists of a coarse crusher, metal detector, grinder and a product silo.

The pulp (containing formic acid) is tanked and transported to be used as a fuel in combustion plants. To be able to handle the pulp, the combustion plants must be equipped with fluidised beds.

4.3.2.8 Odour abatement systems

4.3.2.8.1 General concepts

The malodorous emissions arise from gaseous emissions. These include highly concentrated process gases and vapours from the cooking operation and associated ductwork transferring the gases to the odour abatement plant. Odour emissions also arise from discharges from cookers, presses and/or centrifuges receiving hot rendered material for separation and hot separated materials en route to storage. Other sources include the displacement of malodorous air from the tallow storage tanks; the cleaning of process equipment; fugitive emissions from process buildings and the operation of an odour abatement plant beyond its design specification. They also arise from liquid effluents, including the following: accumulated liquid at the base of the raw material transport containment and on-site storage hoppers; material spillages and floor washings; cooler condensate; the by-products of abatement techniques and treatment/effluent holding tanks. The storage and handling of animal meal and tallow can also cause odour problems [60, United Kingdom 2002].

The proteins and enzymes in ABP undergo thermal and chemical decomposition over time and can produce a range of compounds which may include [160, EFPPRA 2019]:

- sulphurous compounds, e.g. hydrogen sulphide, mercaptans and organic sulphides;
- nitrogenous compounds, e.g. ammonia, amines and amides;
- oxygenated compounds, e.g. ketones, esters, alcohols, aldehydes and acids;
- aliphatic and aromatic compounds, e.g. oils and fats.

Many of these compounds, such as hydrogen sulphide and mercaptans, have very low odour thresholds and can be readily detected by human receptors, even when present in very low concentrations in the environment. Most people are likely to find such odours very offensive and the degree of offensiveness will vary with the intensity of the odour. Exposure to these odours for even a short period may lead to the human receptor making a complaint.

Cooker operating temperatures are specified by the approved cooking method and maintaining the cookers within the approved range, i.e. avoiding cooking at higher temperatures, will minimise odour generation.

The control of odour is best achieved by a hierarchy of full containment in well-sealed process equipment, with local exhaust ventilation to primary abatement, typically thermal oxidation with or without pretreatment in condensers (but other techniques are used and suitable). Treating this smaller volume of concentrated odorous air in primary abatement is easier and cheaper than dealing with large volumes of lower-intensity odour.

However, some odour release into the buildings is inevitable, particularly the raw material reception buildings, and therefore some room air extraction is necessary. Odorous building air is usually extracted into ducting leading into an odour abatement unit using a series of fans. The ongoing energy costs associated with extracting building air and its abatement are high.

In addition, air is often drawn into buildings, particularly raw material reception and storage buildings, to provide cooling and to remove noxious hydrogen sulphide and ammonia gases to control workplace safety. This may be passive or dynamic but either way it increases the volume of air requiring treatment for odour removal, adding to the energy consumption of the fans.

The main issues to be considered in the design of an effective odour control system include the following [160, EFPPRA 2019]:

- Equipment must be well sealed to prevent the release of high-intensity odour and excessive heat to buildings.
- Where point sources of odour are connected to abatement systems, the ventilation system should be designed to minimise the air volumes handled, i.e. low flow / high concentration. However, the local extraction rates must be high enough for efficient capture at the place where the odour is generated.
- During process or abatement plant interruptions, such as cooker faults, a controlled shutdown should be instigated and backup abatement systems employed if necessary. Removal of the heat to the cooker will reduce the temperature of the material inside the cooker and halt the production of non-condensable gases. This can prevent the build-up of odorous gases and potential fugitive releases into the building. Excess steam should be directed to other process applications where possible and only vented to atmosphere in an emergency.
- Where backup odour abatement systems are in place they should be immediately available in case the primary abatement unit goes offline.
- The air extraction systems should be checked and maintained regularly to ensure that sufficient air changes per hour are achieved. A well-balanced, effective extraction system should ensure there is minimal escape of air from the building.

4.3.2.8.2 Condensers

Malodorous emissions which arise from the processing of animal by-products develop and are emitted from a variety of sources. Concentrated emissions, such as vapours and non-condensable gaseous products, are emitted directly from cookers. These are captured directly from cookers and/or by the extraction equipment over presses.

In a typical rendering odour abatement system, high-intensity cooking vapours are passed through a condenser(s) to separate condensable and non-condensable gases. The vapour from cookers and meal presses can be extracted and ducted to an air-cooled condenser for example. Drop-out pots situated within the ducting, upstream of the condensers, remove solid material entrained in the gas stream. The condensers reduce the temperature of the extracted vapour stream and condense out the aqueous fraction and some organic compounds. Where this is done, the non-condensable gases are passed for further abatement (e.g. thermal oxidation) and the condensate is either treated on site in a waste water treatment plant or at an off-site plant [160, EFPPRA 2019].

High-efficiency condensers (chilled water condensers / glycol systems) can increase condensing performance and the residual air may be suitable for abatement in a biofilter or chemical scrubber rather than using energy-intensive thermal oxidation.

See also Section 2.3.8.2.10.

4.3.2.8.3 Thermal oxidation

Highly odorous cooking vapours can be effectively destroyed by thermal oxidation with high odour removal efficiencies. The gases can be extracted into the combustion chamber of a thermal oxidiser or passed through a condenser to remove the condensable fraction and the non-condensable gases passed to the combustion chamber of a boiler or incinerator.

Where an oxidiser is also used for process steam production, it is important that there are controls in place to prevent the reduction or loss of incineration capacity when the process steam demand falls. This is also true for boilers. These will usually comprise diversional controls to other process areas or to atmosphere and will prevent spikes of high-intensity odour overloading secondary systems. Standby or alternative systems should be separate from the process demands to maintain treatment capacity in abnormal circumstances.

It is important in facilities using a condenser-boiler configuration that the temperature within the boiler combustion zone is maintained to ensure adequate destruction of the odorous emissions. In some cases (start-up/shutdown), this may lead to steam release until the minimum temperature is achieved to avoid incomplete odour destruction in the boilers [160, EFPPRA 2019].

See also Section 2.3.8.2.13.

4.3.2.8.4 Biofilters

Biofilters are normally used for abating lower-intensity odours such as extracted building air. They are a form of biological treatment which is achieved by the metabolism of organic compounds to non-odorous products – a biological oxidation process which consumes carbon (from organic contaminants in the gas stream) and oxygen, giving rise to carbon dioxide, water and biomass. Intermediate products may be acidic.

The bacteria require a continual feed of organic material and are therefore most effective when treating a consistent air stream. They will hibernate during periods where no foul air is being supplied and if such periods extend for several days bacteria die-off may occur or the pick-up in performance will take time. Bacteria also struggle to deal with spikes of intense odours, e.g. during extreme conditions such as sudden very hot or very cold weather or shock loading with high-intensity inlet air, and such periods may cause bacterial die-off and a marked reduction in the treatment capacity of the biofilter until bacteria recover. Recovery may require reseeded.

Biofilters usually have concrete walls or walls made from wooden slats covered with plastic and have concrete slats over a void space (plenum chamber). The filter media are housed above a plastic mesh sheet covering the slats to prevent the media falling through the slats and blocking the drainage outlets. The odorous air is pretreated, drawn through a humidifier unit or water scrubber by large fans where high-pressure water is sprayed directly into the flow of the air to remove any solid particles. The air is then forced underneath the biofilter and it passes up through the media where the bacteria break down the odorous compounds. Leachate collects in chambers under the beds and is sent to an on-site waste water treatment plant or off site for treatment [160, EFPPRA 2019].

See also Section 2.3.8.2.8.

4.3.2.8.5 Chemical scrubbers

Chemical scrubbers are an alternative or addition to biofilters and are a good option where limited space is available. They are mostly used for abating lower-level odours such as extracted building air but can be used for treating more odorous process air, either as a standby system or as the primary treatment.

Multi-stage scrubbing is usually specified for the more complex odour streams from animal by-product processors and is often combined with an initial venturi scrubber for dust removal and a final polishing dry media filter for insoluble VOC removal.

The incoming gas stream to be treated is met by an opposing stream of neutralising reagent, which falls from spray nozzles in the different sections of the scrubber. The sections below the spray nozzles are packed with a medium, usually plastic, designed to give a maximum surface area of contact between the reagent and the gas stream to ensure the maximum abatement is achieved [160, EFPPRA 2019].

See also Section 2.3.8.2.11.

4.3.2.9 Sludge management options

Sludge from a biological WWTP can be managed on site or off site, depending on the market demands around the rendering plant.

Sludge categorised as Category 1 can be reused in the meal processing line. This technique requires the separation of process and other waste water streams (e.g. from sanitary facilities, canteens, social rooms, offices, etc.) in order to reuse excess sewage sludge and filter material from the WWTP in the production of animal by-products [113, Waxwender et al. 2016].

Sludge from the WWTP can also be dried by recovering heat from the installation; the dried sludge can be sent off site for combustion and recovery of phosphorus from the ashes [185, Karlis et al. 2020].

Sludge generated from waste water that has been in contact with Category 1 material can be treated as Category 1 ABP and sent to ultrafiltration. The liquid phase (around 35 % of the waste water generated) is reused in the installation for cleaning, truck washing, steam production and cleaning of the reverse osmosis systems for boilers; the solid phase can be sent off site to incineration [155, Karlis et al. 2019].

4.3.3 Current emission and consumption levels

4.3.3.1 Energy consumption

Data from installations applying rendering, fat melting, blood and/or feather processing are presented in this section.

Figure 4.17 shows data (from installations participating in the data collection, for the years 2016 to 2018) on total specific net energy consumption in kWh/tonne of raw material at installation level, as well as the applied techniques to reduce energy consumption.

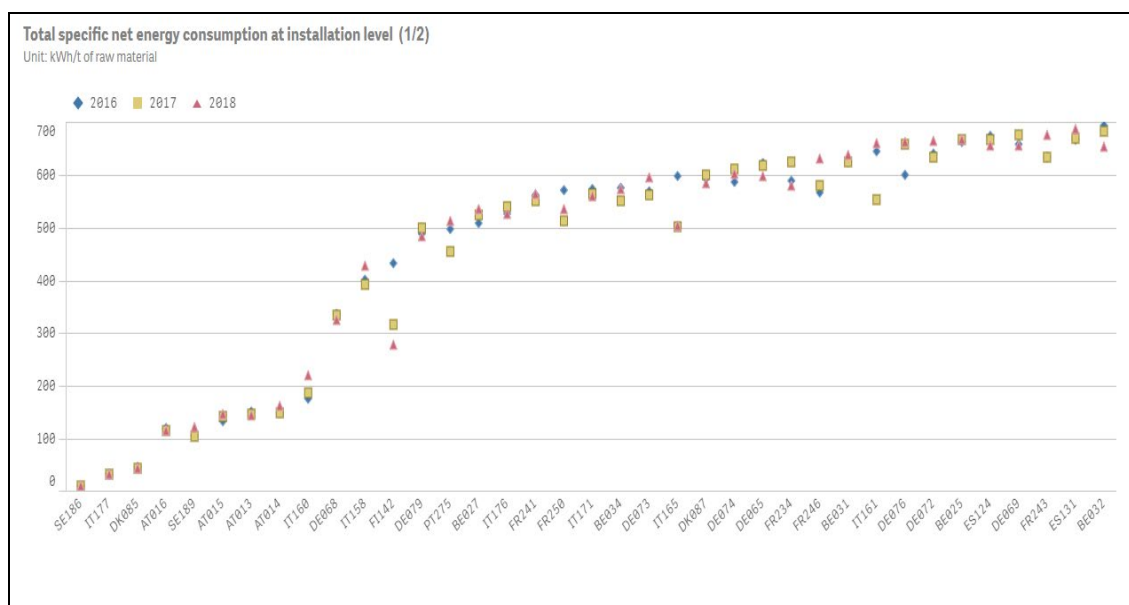

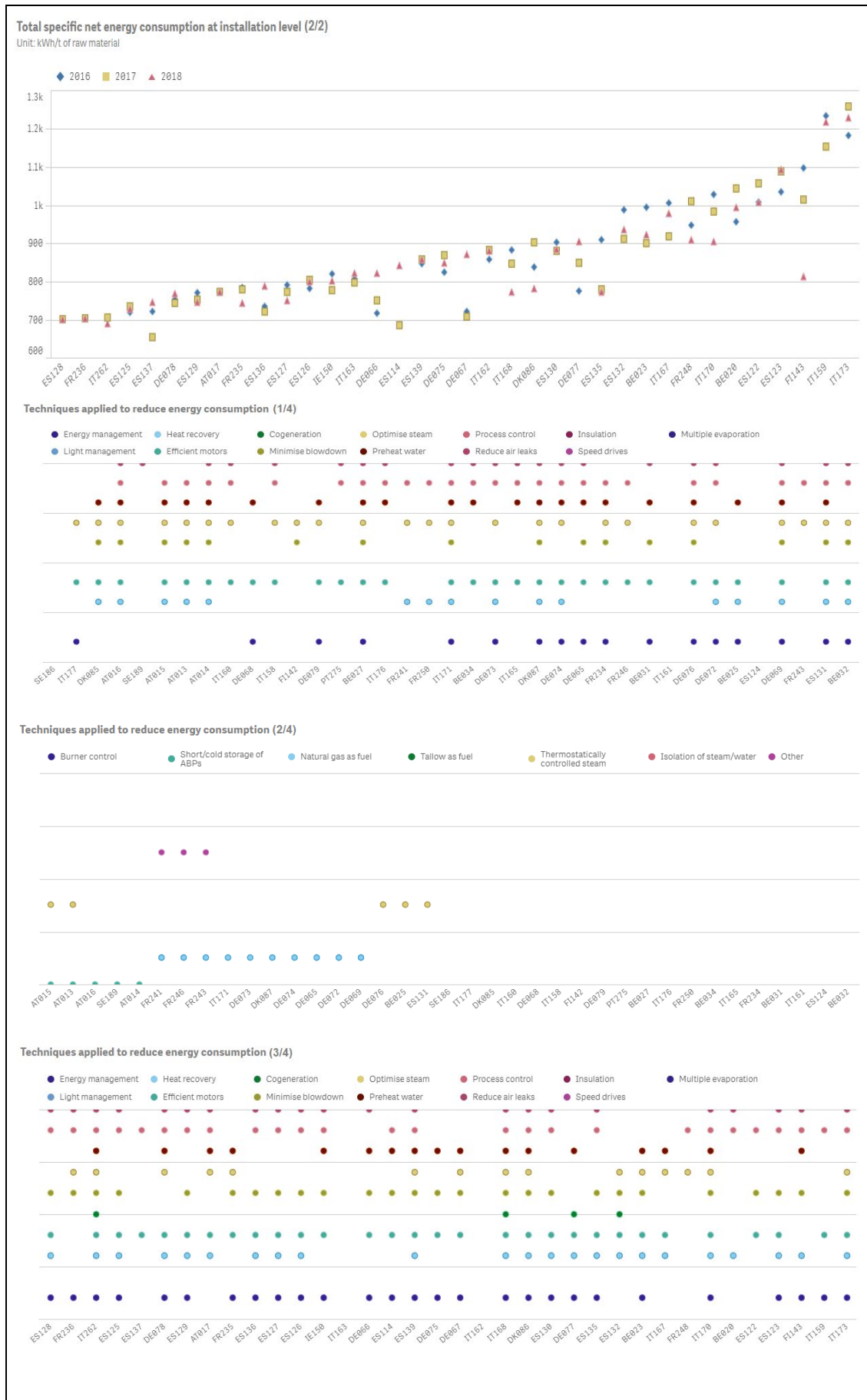

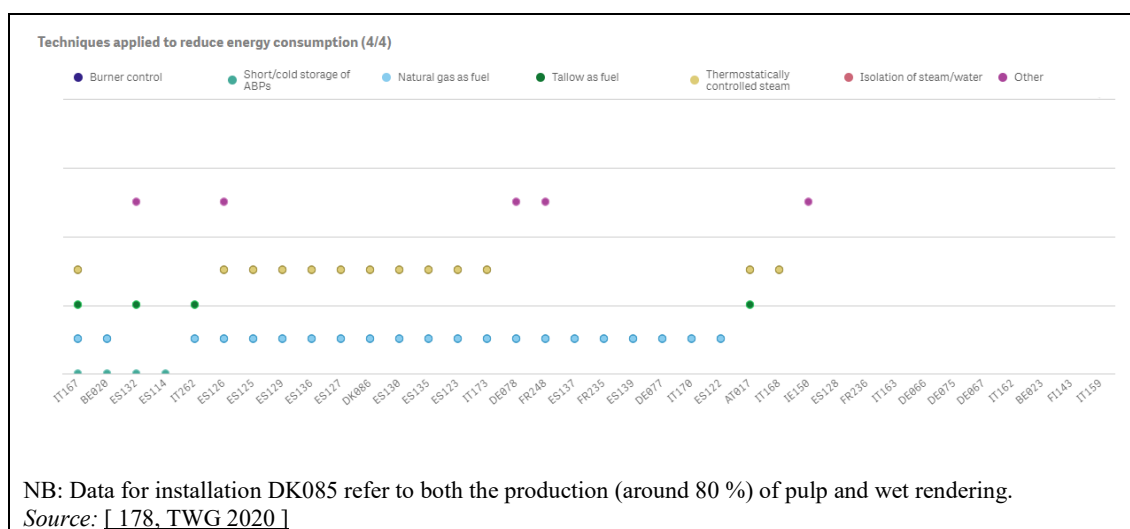

Figure 4.17: Specific net energy consumption (kWh/tonne of raw material) and applied techniques to reduce energy consumption in rendering, fat melting, blood and/or feather processing

Figure 4.18 shows data (from installations participating in the data collection, for the years 2016 to 2018) on total specific net electricity and heat consumption in kWh/tonne of raw material at installation level.

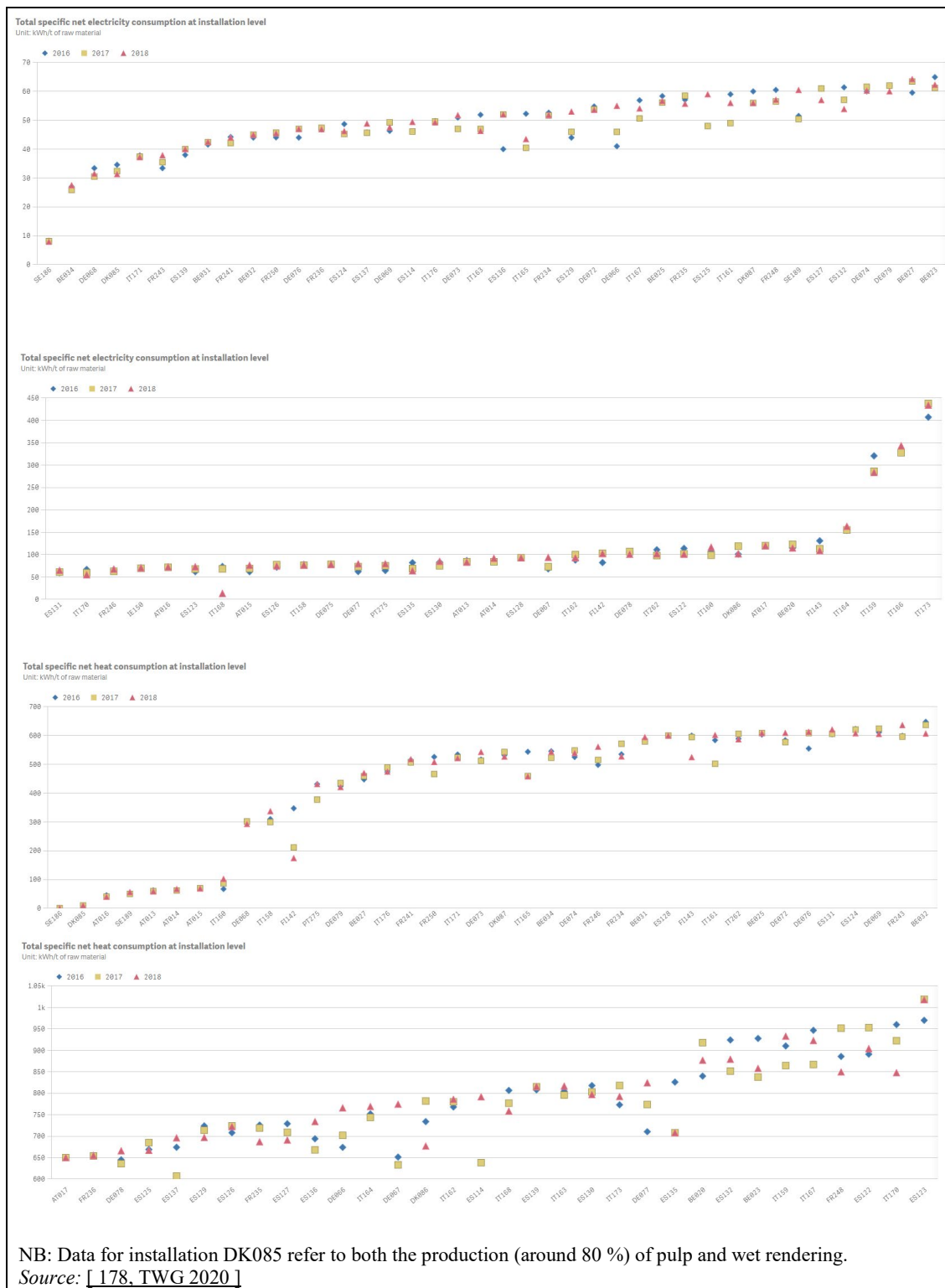

Figure 4.18: Specific net electricity and heat consumption (kWh/tonne of raw material) in rendering, fat melting, blood and/or feather processing

Figure 4.19 and Figure 4.20 show the specific net energy consumption (from installations participating in the data collection, for the years 2016 to 2018) in kWh/tonne of raw material in some processes (rendering, fat melting, blood and/or feather processing).

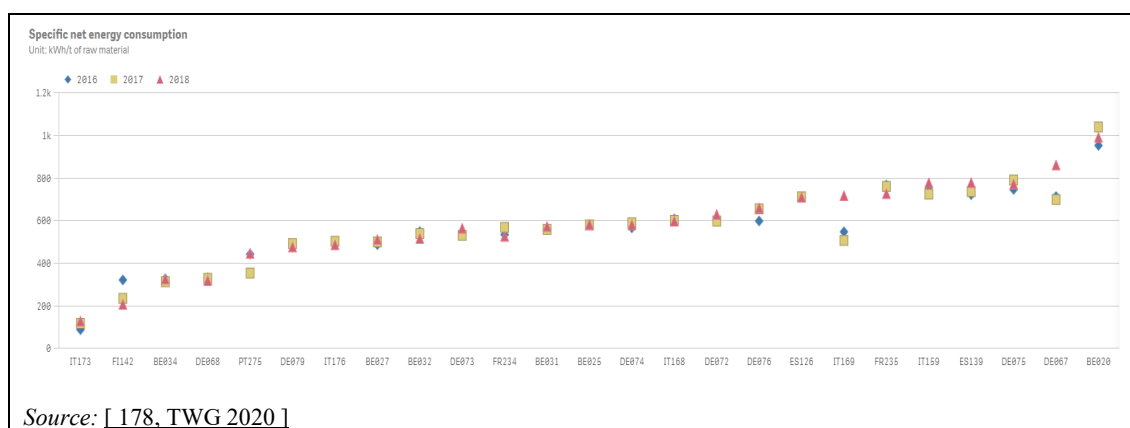

Figure 4.19: Specific net energy consumption (kWh/tonne of raw material) for drying and cooking/sterilisation in rendering, fat melting, blood and/or feather processing

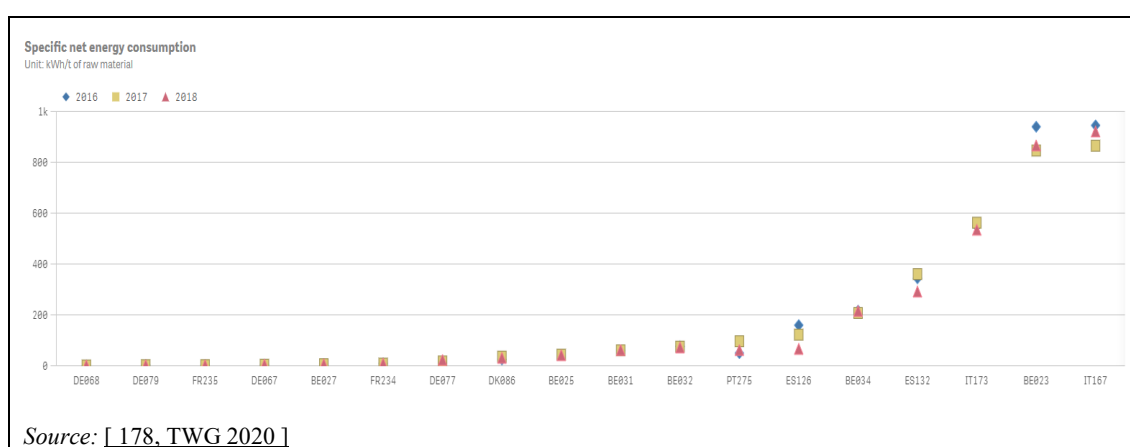

Figure 4.20: Specific net energy consumption (kWh/tonne of raw material) for waste gas treatment in rendering, fat melting, blood and/or feather processing

4.3.3.2 Water consumption

Figure 4.21 and Figure 4.22 show reported data (from installations participating in the data collection, for the years 2016 to 2018) on specific net water consumption, in m^3/tonne of raw material, from rendering of animal by-products and/or edible co-products (rendering, fat melting, blood and/or feather processing) at installation level.

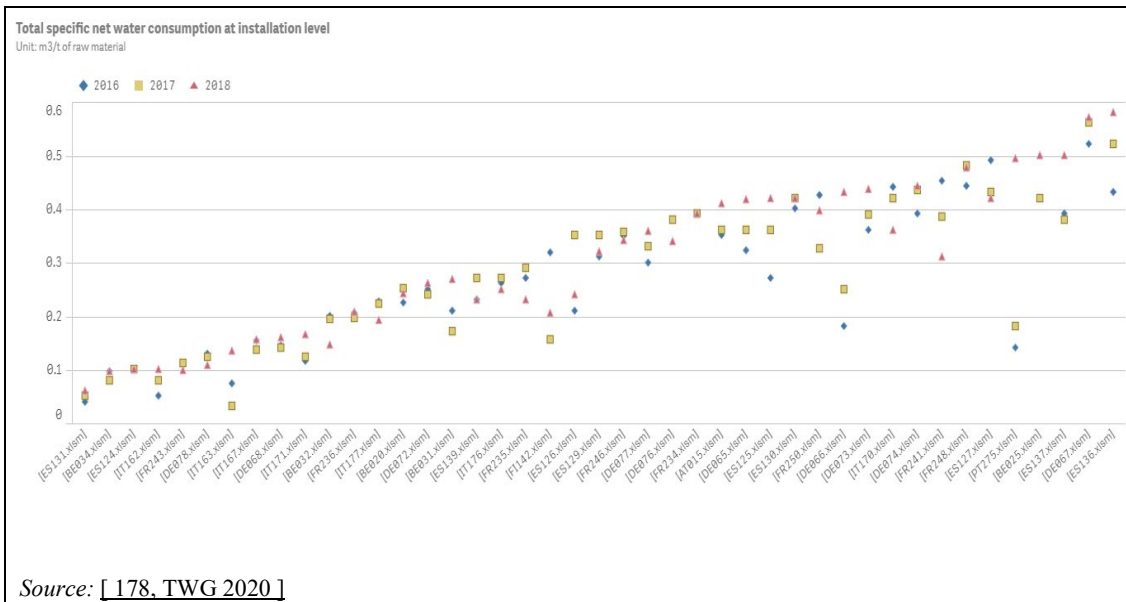

Figure 4.21: Specific net water consumption (m³/tonne of raw material) in rendering of animal by-products and/or edible co-products (installation level) (Part 1 of 2)

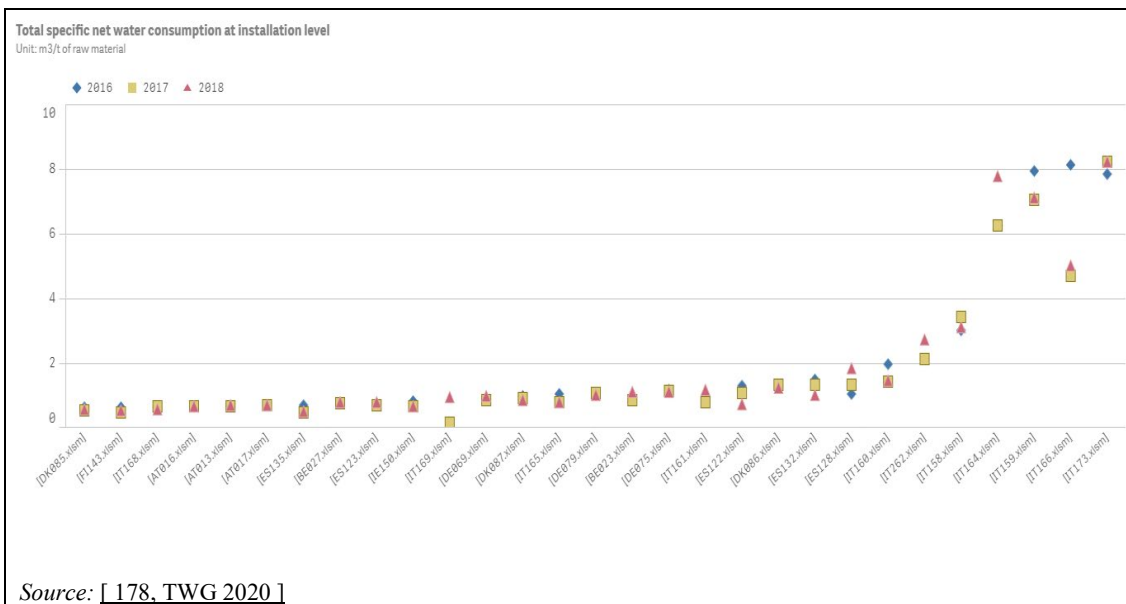

Figure 4.22: Specific net water consumption (m³/tonne of raw material) in rendering of animal by-products and/or edible co-products (installation level) (Part 2 of 2)

Figure 4.23, Figure 4.24 and Figure 4.25 show the specific net water consumption (from installations participating in the data collection, for the years 2016 to 2018), in m³/tonne of raw material, for several specific processes in rendering of animal by-products (rendering, fat melting, blood and/or feather processing).

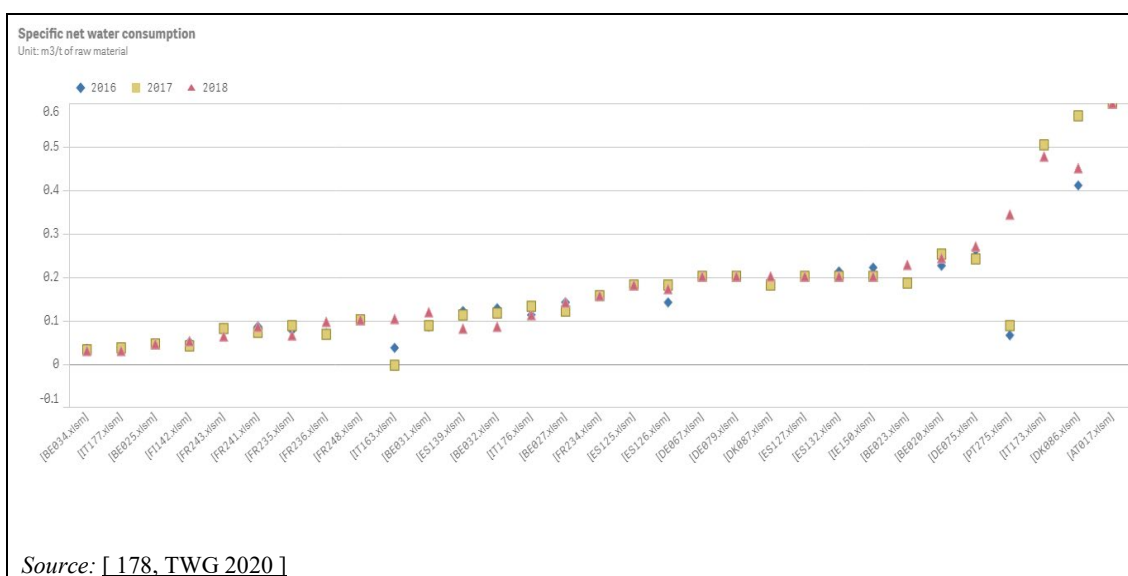

Figure 4.23: Specific net water consumption (m³/tonne of raw material) for boilers in rendering of animal by-products and/or edible co-products

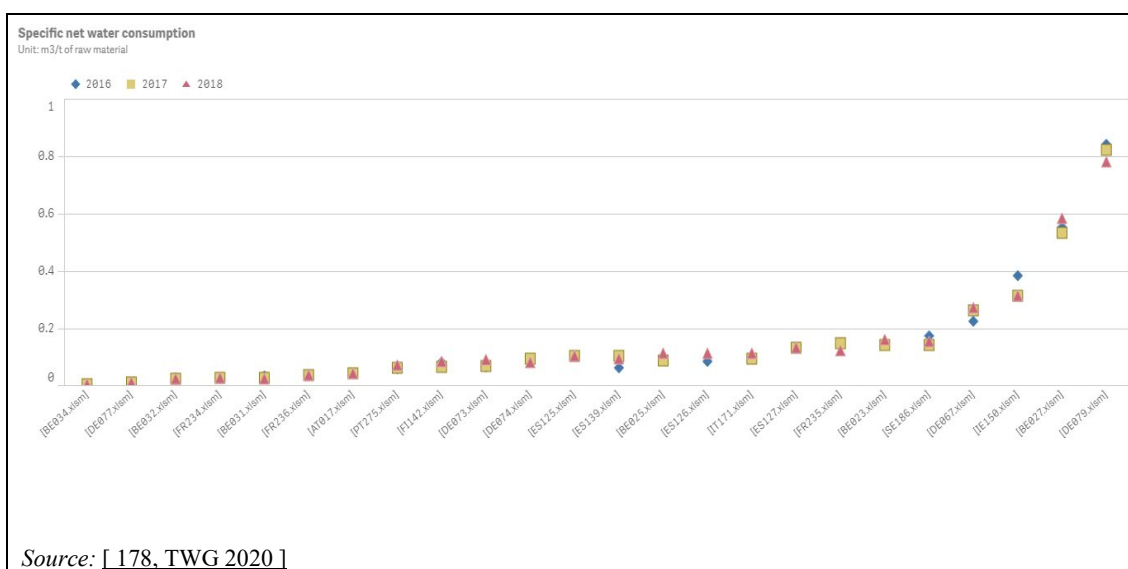

Figure 4.24: Specific net water consumption (m³/tonne of raw material) for cleaning of floors/walls and equipment in rendering of animal by-products and/or edible co-products

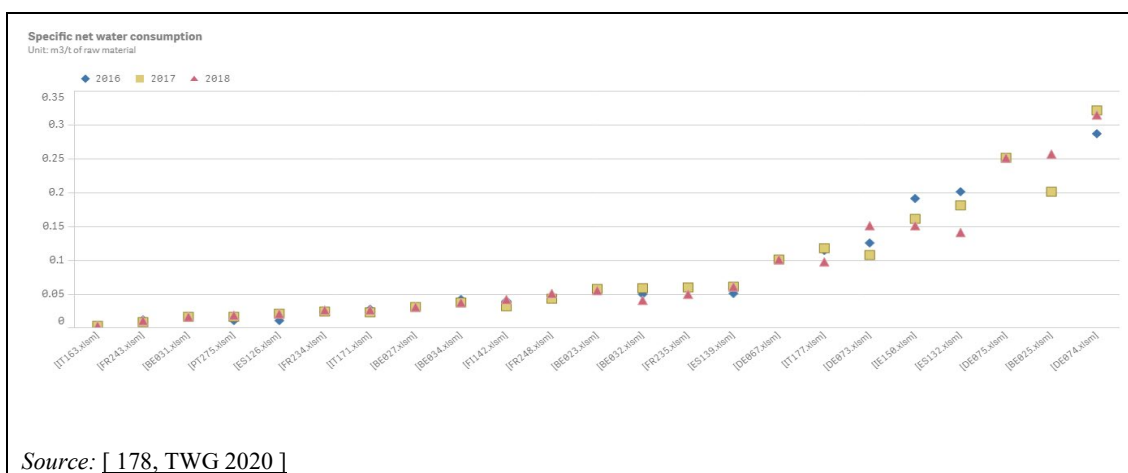

Figure 4.25: Specific net water consumption (m³/tonne of raw material) for vehicle washing in rendering of animal by-products and/or edible co-products (rendering, fat melting, blood and/or feather processing)

4.3.3.3 Emissions to water

Figure 4.26 and Figure 4.27 show reported data (from installations participating in the data collection, for the years 2016 to 2018) on specific waste water discharges in m³/tonne of raw material from rendering (rendering, fat melting, blood and/or feather processing) of animal by-products and/or edible co-products and all types of discharges. The applied techniques for reducing water consumption are also shown.

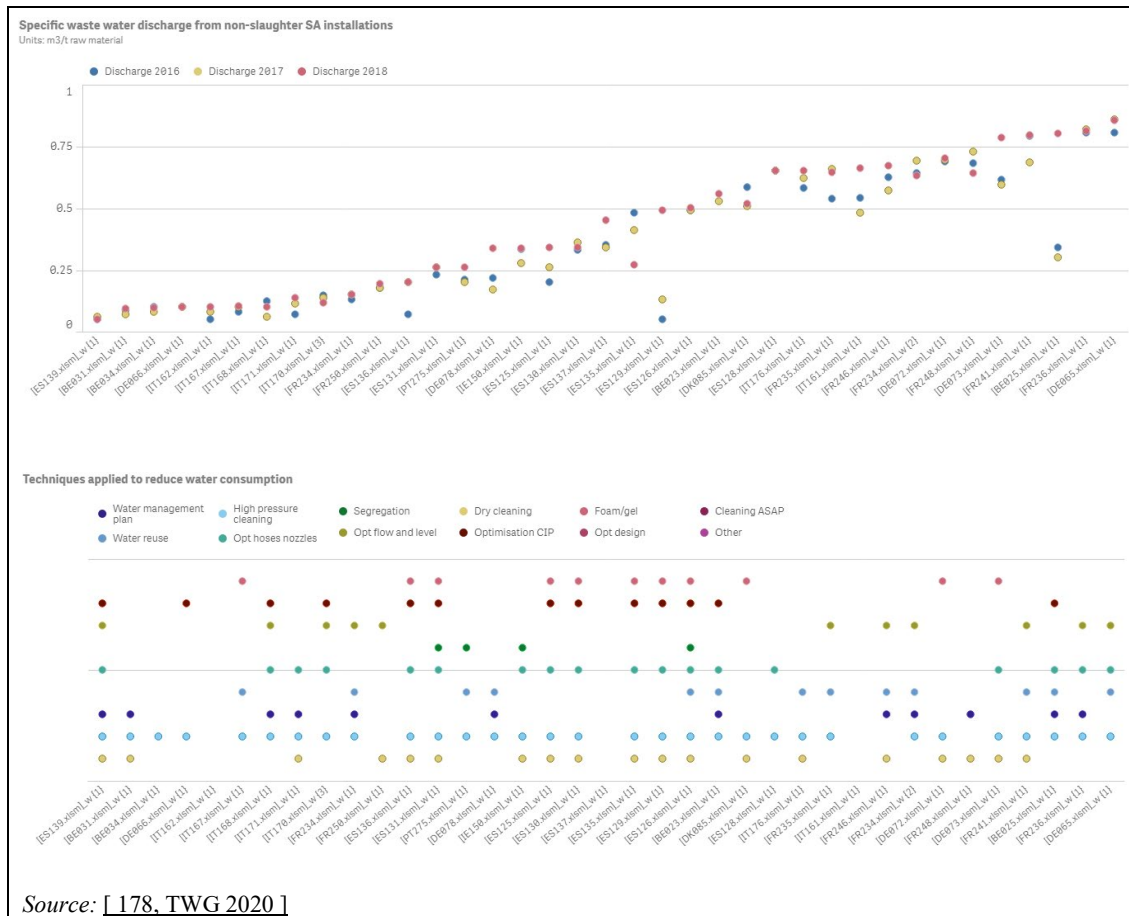

Figure 4.26: Specific waste water discharge (m³/tonne of raw material) and applied techniques for reducing water consumption in rendering of animal by-products and/or edible co-products for all types of discharges (Part 1 of 2)

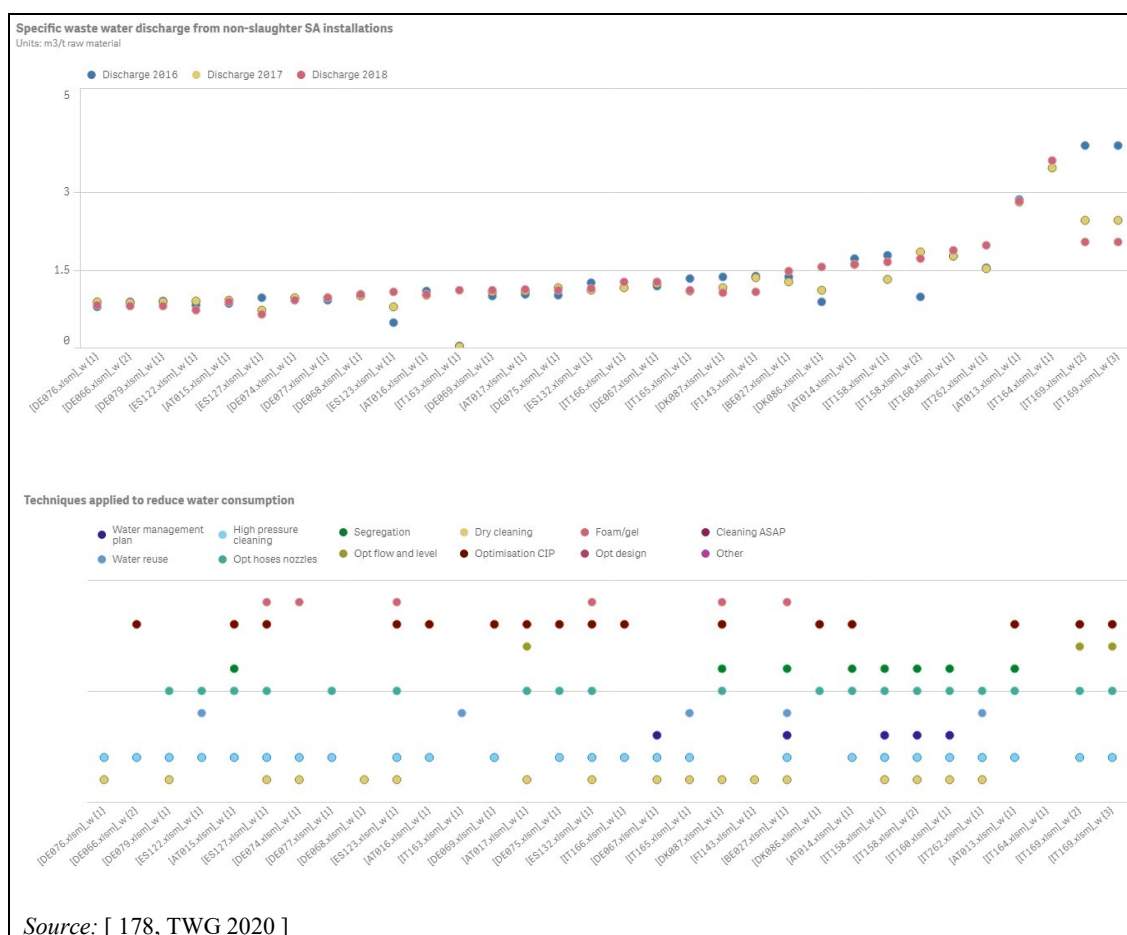

Figure 4.27: Specific waste water discharge (m³/tonne of raw material) and applied techniques for reducing water consumption in rendering of animal by-products and/or edible co-products for all types of discharges (Part 2 of 2)

It should be noted that, in some cases, treating surface run-off water can be a permit condition (e.g. for AT013). Thus the amount of waste water to be discharged can be influenced by weather conditions (rain).

The waste water comprises the following: production waste water; rinsing water from the vehicles and raw material storage; the water fraction from mechanical blood separation; vapour condensate from sterilisation and drying and from abatement techniques, such as seeping water from a biofilter [29, Germany 2001]. The composition varies a lot depending on the process and the freshness of the feedstock. On average, one tonne of raw material is reported to produce 5 kg of COD, 600 g of nitrogen [23, Nordic 2001] and 1.65 kg of solids [24, Det Norske Veritas 2001], before waste water treatment.

In total, 50-90 % of the waste water contamination originates from the vapour condensate. If wet rendering is undertaken, there will be a higher volume of contaminated waste water produced. Breakdown products of degradation of the raw material are conveyed into the waste water through the vapours from sterilisation and drying of the material. The amount of water pollutants expelled during processing is less for fresh animal by-products than for raw materials that have been allowed to decompose [29, Germany 2001].

Waste water from the cleaning of the 'clean side' of the process has a considerably lower load than that from the 'unclean side'. This does not increase proportionately with the size of the plant. Waste water from the exhaust air treatment comprises waste water from the process exhaust air and from the room exhaust air. The treatment can be done together or separately. The waste water from the process exhaust air treatment can be highly loaded with organic components, up to

25 g/l COD; ≤ 2 g/l mercaptans ; ≤ 800 mg/l hydrogen sulphide ; ≤ 400 mg/l ammonium nitrogen; volatile oils, phenols, aldehydes and others [29, Germany 2001].

Waste water from the lorry cleaning may contain mineral oil, solids and possibly cleaning agents [29, Germany 2001].

De-sludging waste water from the evaporators has hardly any organic load, but it may contain phosphorus compounds from any conditioning agents used. It can also have high pH values, which need to be neutralised. There is also waste water from the de-sludging of the cooling water recirculation [29, Germany 2001].

4.3.3.4 Emissions to air

Odour

Malodorous compounds may be organic or inorganic. High odour strength is not necessarily associated with high chemical concentrations. Where emissions of different odour intensity are produced within the process, the odour streams may be kept separate and treated by the appropriate odour abatement plant. It is possible to build in a facility to ensure that, in the event of an odour abatement plant malfunction or breakdown, malodorous air is diverted to an alternative suitable odour abatement plant [60, United Kingdom 2002].

Figure 4.28 and Figure 4.29 show reported data (from installations participating in the data collection, for the years 2016 to 2018) for channelled emissions of odour, as well as the applied abatement techniques, from rendering, fat melting, blood and/or feather processing.

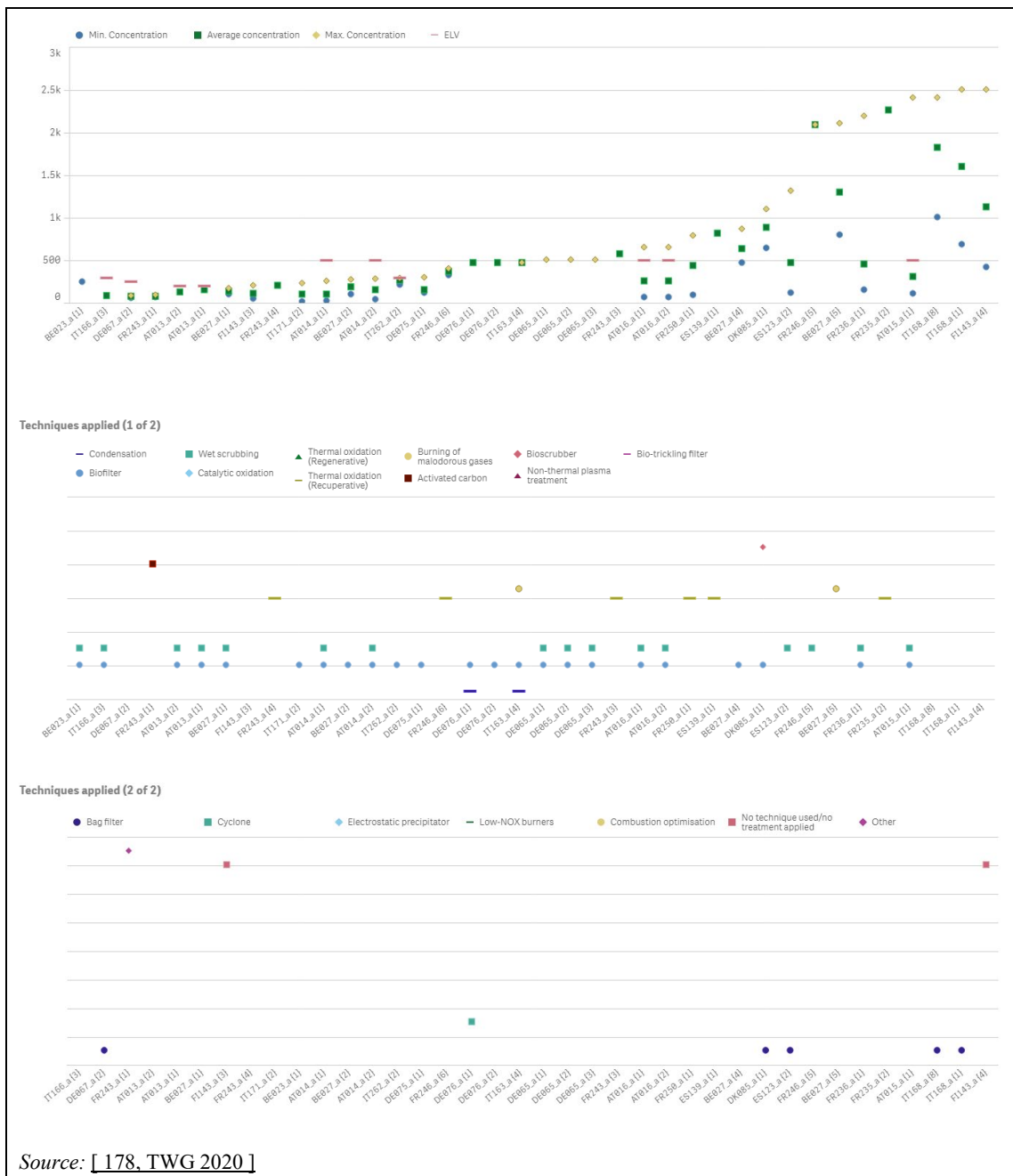

Figure 4.28: Odour emissions (OUE/m³) and abatement techniques from rendering, fat melting, blood and/or feather processing (Part 1 of 2)

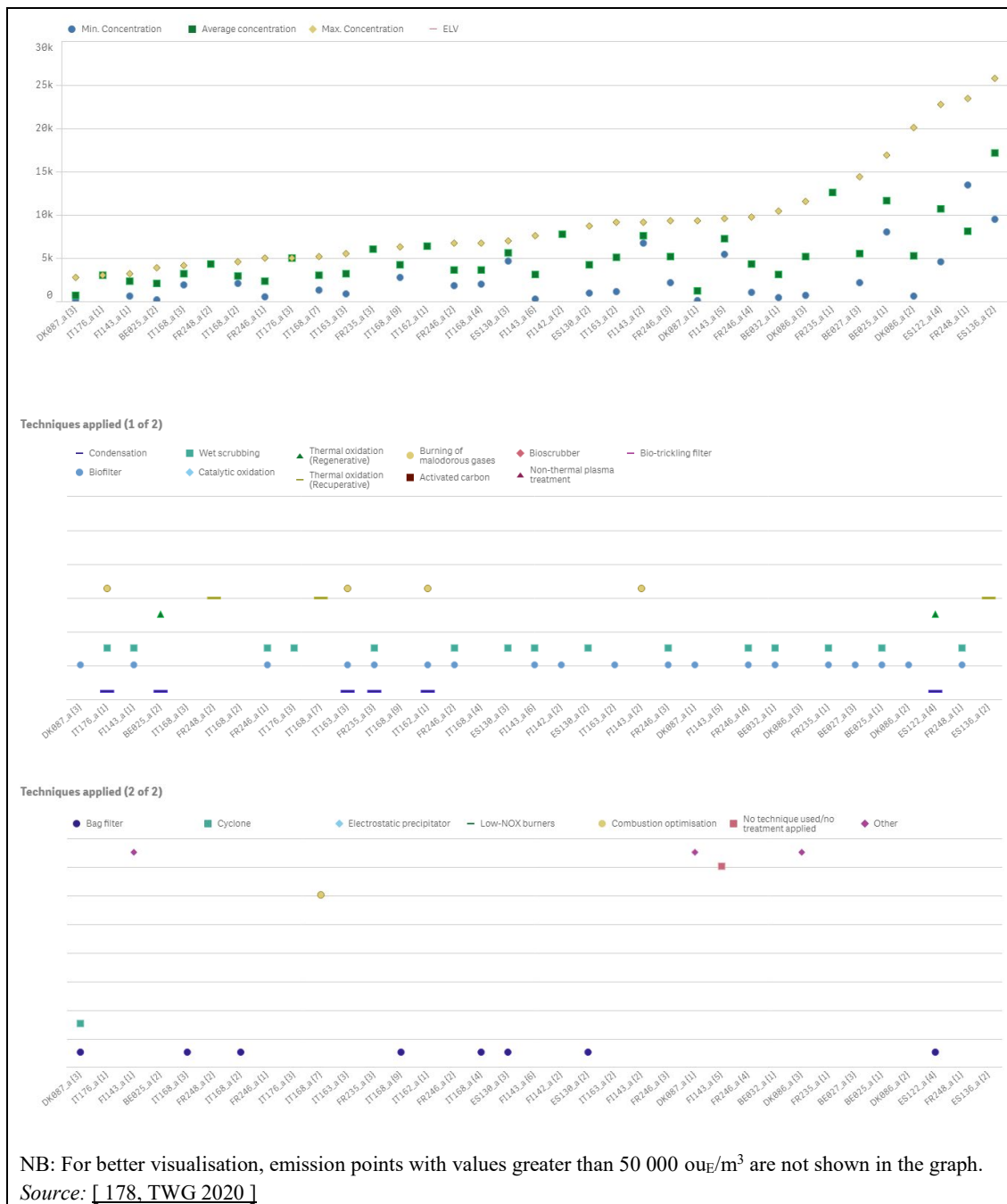

Figure 4.29: Odour emissions (ouE/m³) and abatement techniques from rendering, fat melting, blood and/or feather processing (Part 2 of 2)

TVOC

Figure 4.30 and Figure 4.31 show reported data (from installations participating in the data collection, for the years 2016 to 2018) for channelled TVOC emissions to air, as well as the applied abatement techniques, from rendering, fat melting, blood and/or feather processing.

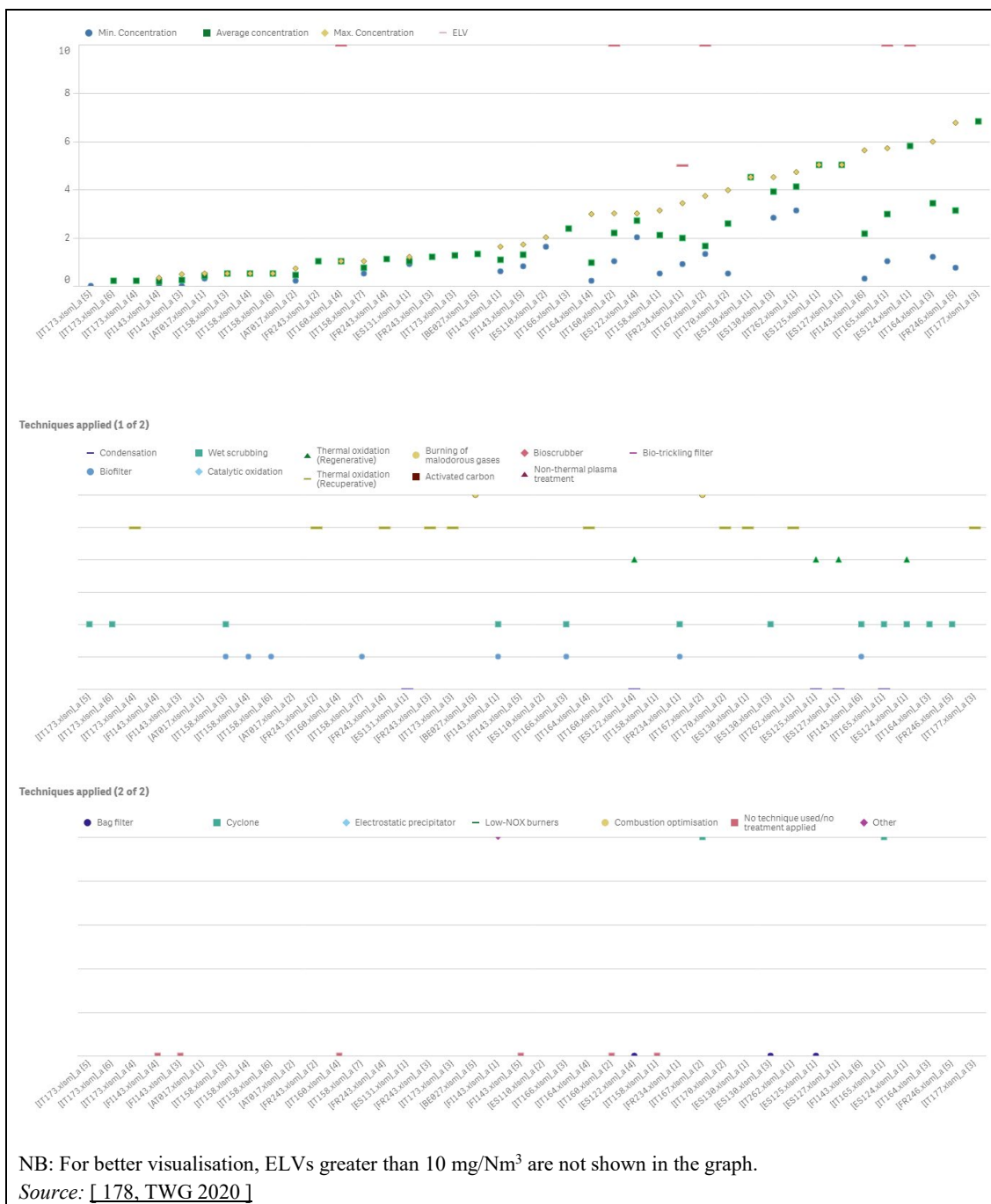

Figure 4.30: TVOC emissions to air (mg/Nm³) and abatement techniques from rendering, fat melting, blood and/or feather processing (Part 1 of 2)

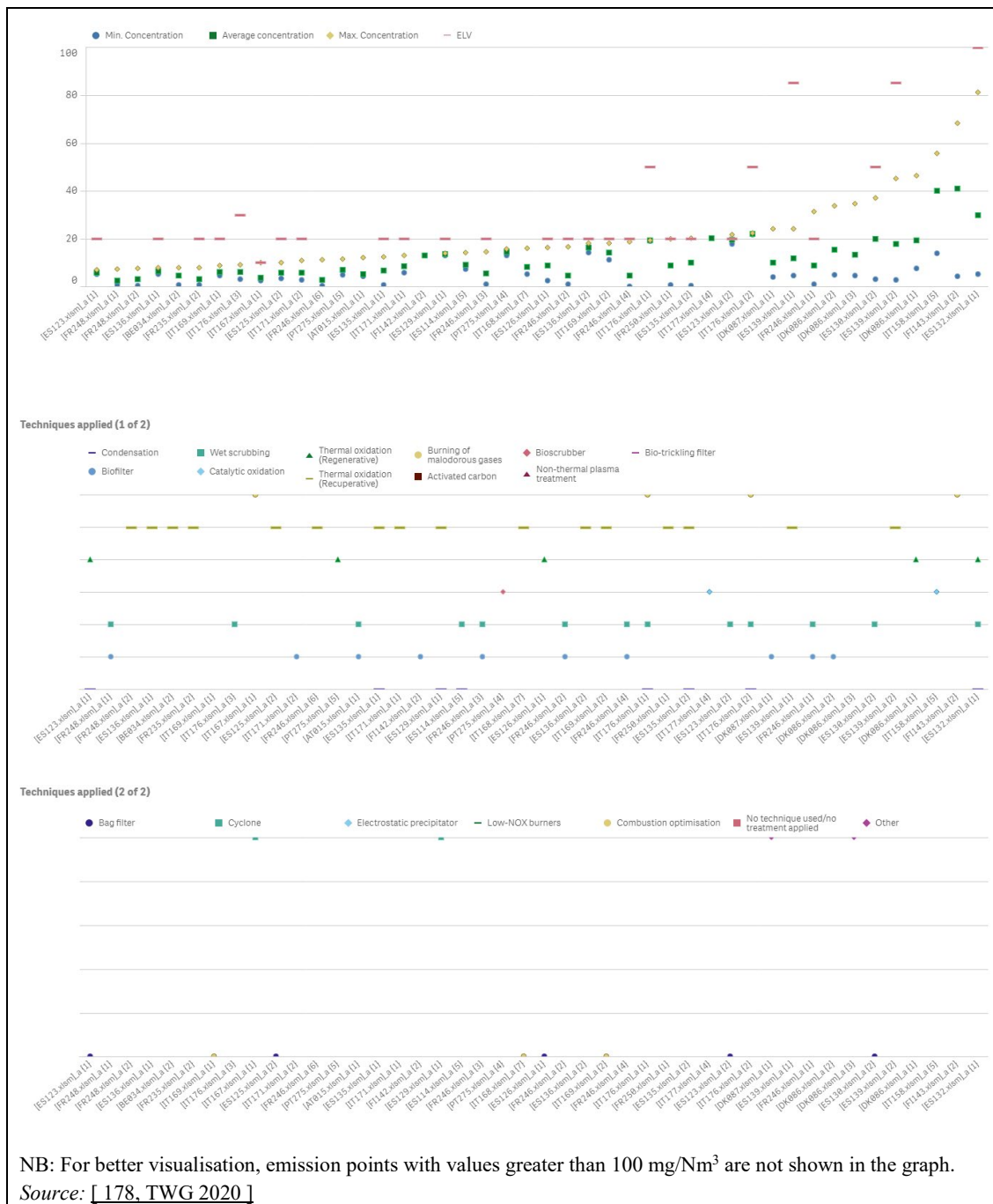

Figure 4.31: TVOC emissions to air (mg/Nm³) and abatement techniques from rendering, fat melting, blood and/or feather processing (Part 2 of 2)

NH₃

Figure 4.32 and Figure 4.33 show reported data (from installations participating in the data collection, for the years 2016 to 2018) for channelled NH₃ emissions to air, as well as the applied abatement techniques, from rendering, fat melting, blood and/or feather processing.

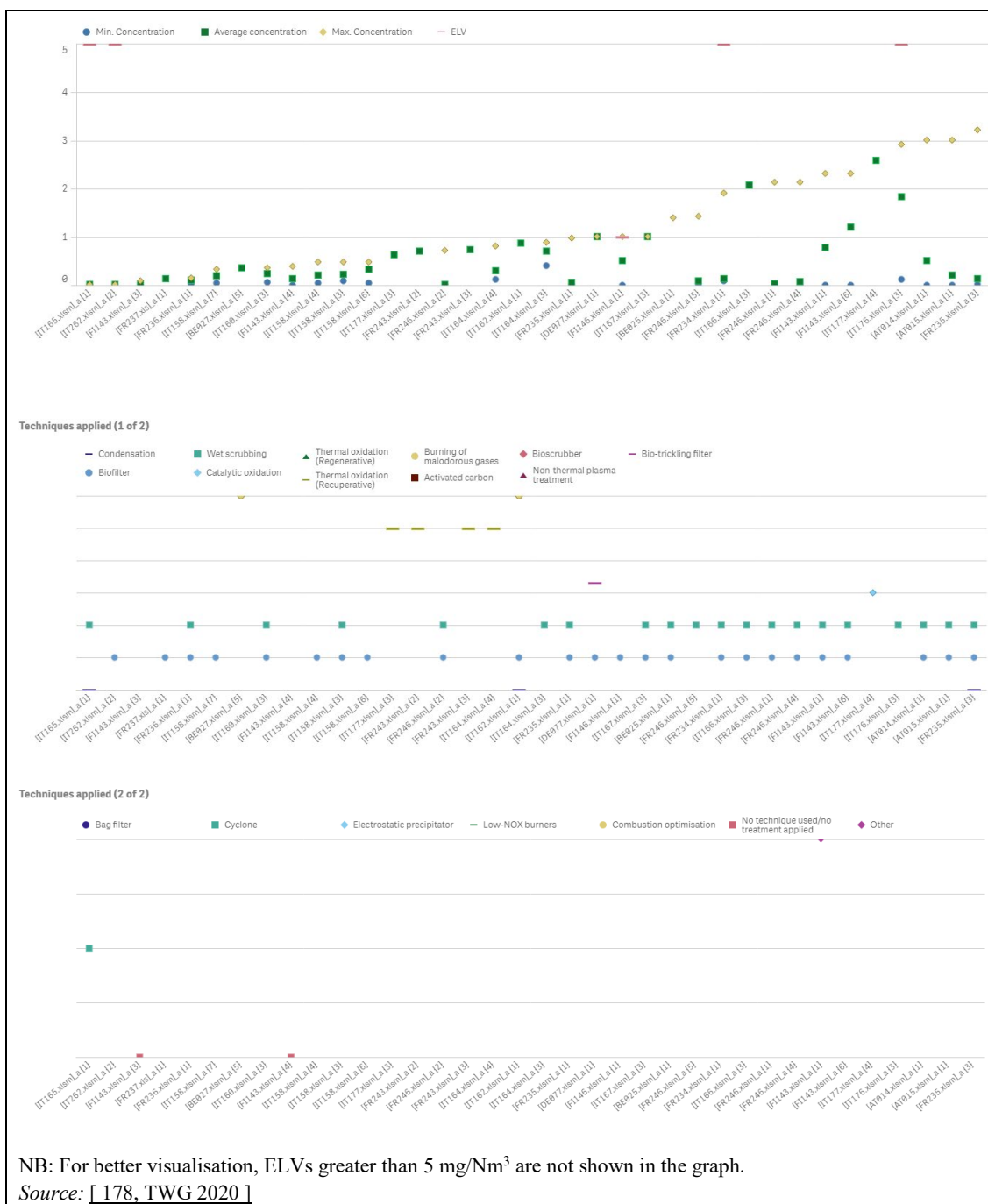

Figure 4.32: NH₃ emissions to air (mg/Nm³) and abatement techniques for rendering, fat melting, blood and/or feather processing (Part 1 of 2)



NB: For better visualisation, emission points with values greater than 50 mg/Nm³ are not shown in the graph.

Source: [178, TWG 2020]

Figure 4.33: NH₃ emissions to air (mg/Nm³) and abatement techniques from rendering, fat melting, blood and/or feather processing (Part 2 of 2)

H₂S

Figure 4.34 and Figure 4.35 show reported data (from installations participating in the data collection, for the years 2016 to 2018) for channelled H₂S emissions to air, as well as the applied abatement techniques, from rendering, fat melting, blood and/or feather processing.

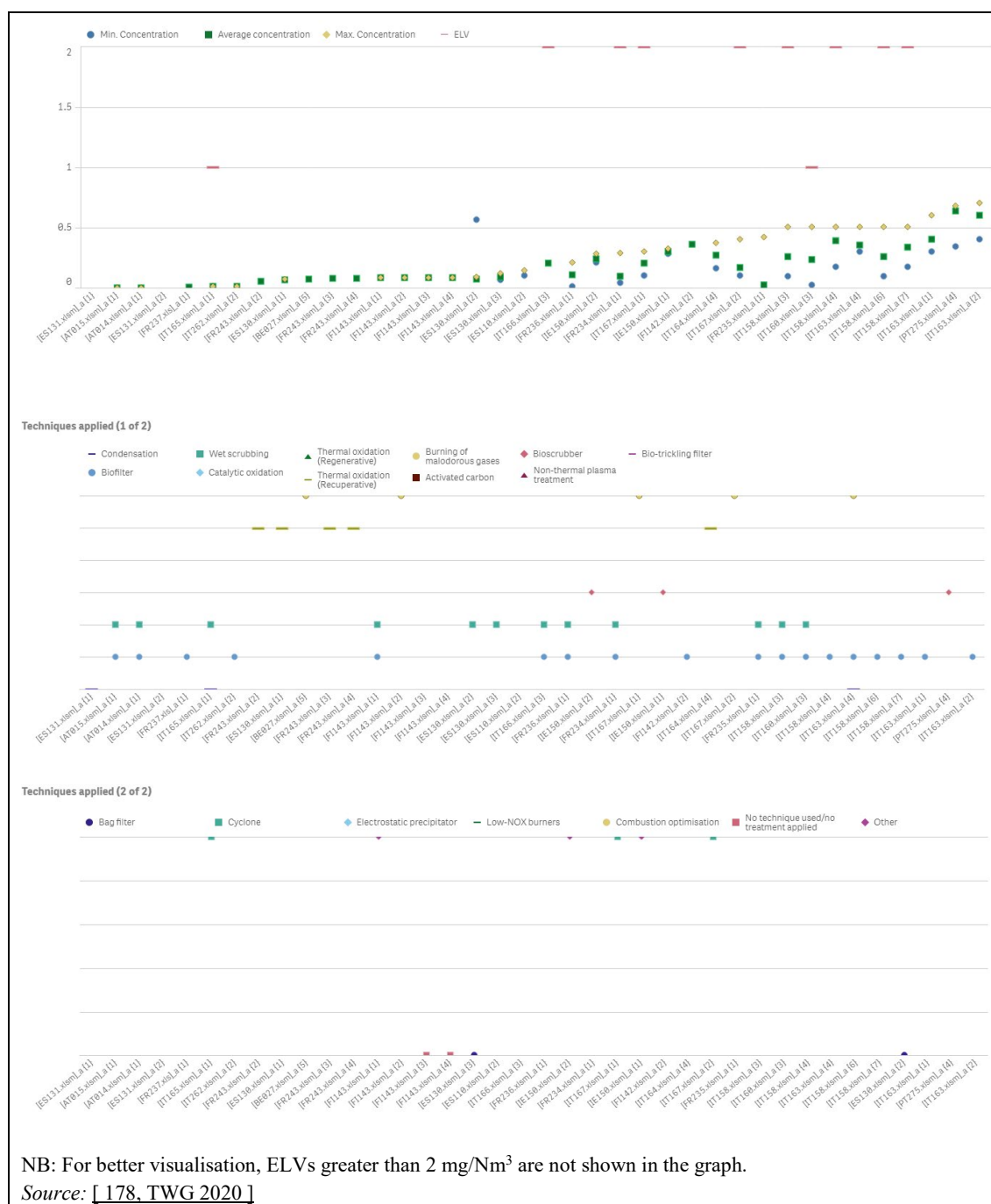

Figure 4.34: H₂S emissions to air (mg/Nm³) and abatement techniques from rendering, fat melting, blood and/or feather processing (Part 1 of 2)

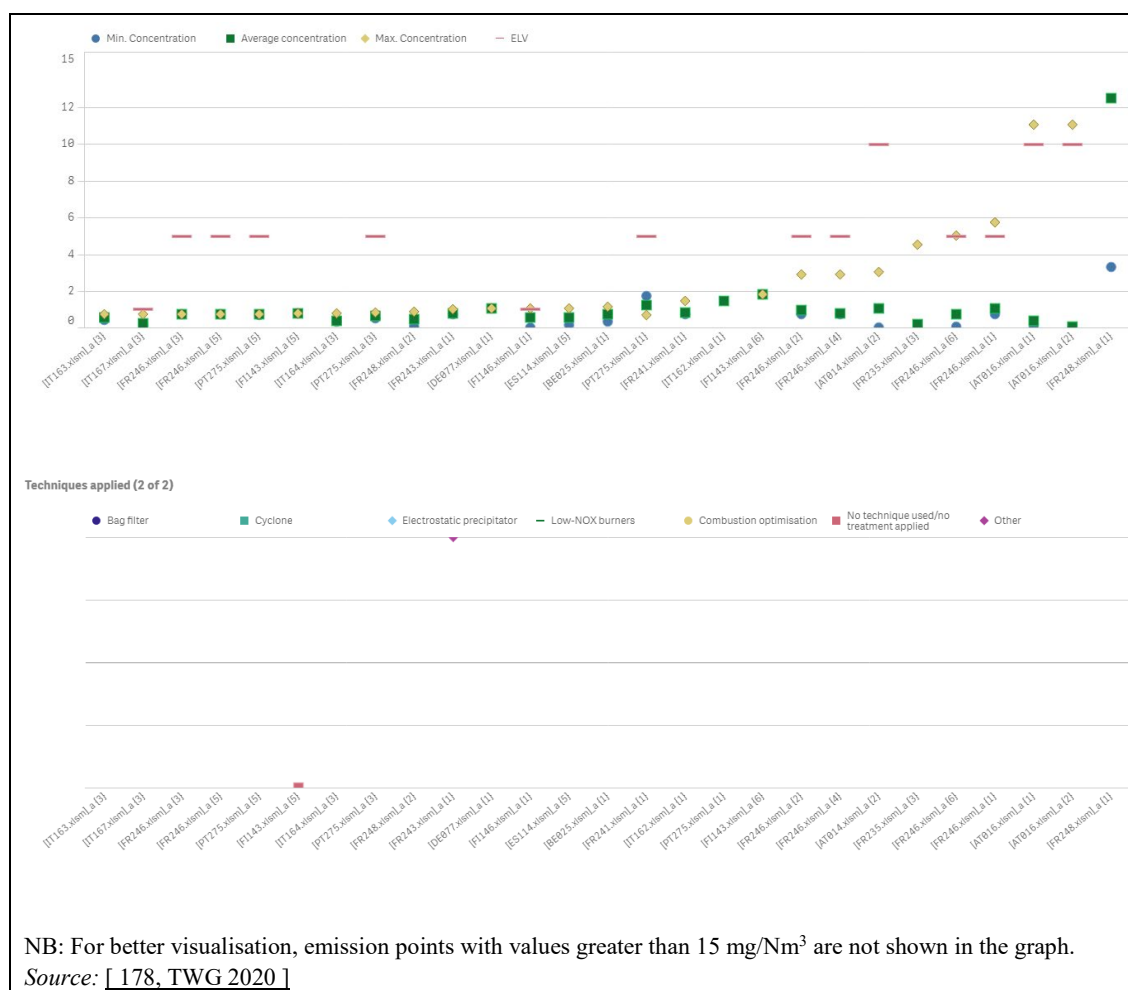

Figure 4.35: H₂S emissions to air (mg/Nm³) and abatement techniques from rendering, fat melting, blood and/or feather processing (Part 2 of 2)

4.3.3.5 Noise and vibration

New plants are usually constructed on the outskirts of towns, at least 1 km from residential areas. The reference noise levels of 60 dB(A) during the day and 45 dB(A) during the night can reportedly be achieved without particular noise-reducing measures. In existing installations close to residential areas, significant noise emissions can occur. Some reported sources of noise problems are induced fans, scrubbing towers, filtration equipment and conveyors [24, Det Norske Veritas 2001].

4.3.4 Techniques to consider in the determination of BAT

4.3.4.1 Techniques to reduce emissions to water

4.3.4.1.1 Use of H₂O₂ to remove H₂S from waste water in feather rendering plants

Description

For waste water with high sulphide concentrations, e.g. from feather processing, the reduction of the H₂S concentration is a high priority. Concentrations from about 80-100 mg/l of sulphide will impair the activated sludge biocoenosis and thus the biological treatment process in the downstream biological stage.

Hydrogen peroxide can be added to the waste water to oxidise the sulphide into SO₂, which is then removed with NaOH.

Environmental performance and operational data

To oxidise 1 kg of sulphide stoichiometrically, around 13 litres of 30 % hydrogen peroxide are needed. The reaction takes approximately 10 minutes. If surplus hydrogen peroxide is used the reaction time will be less, e.g. at a 50 % surplus the reaction takes approximately 5 minutes.

Example plants

A German rendering plant.

Reference literature

[29, Germany 2001], [62, Germany 2002] [156, TWG 2019].

4.3.4.2 Techniques to reduce emissions to air

4.3.4.2.1 Ammonia stripping of exhaust vapour condensates from rendering

Technical description

The following example of a stripping plant for the exhaust air treatment in a biofilter describes the purification performance. The stripping plant consists of two columns which are dimensioned as follows:

Influent to the stripping plant:	75 m ³ /d
Filling body height:	~8 m
Throughput of column 1:	2 100 l/h
Throughput of column 2:	3 000 l/h
Column entry temperature:	~60 °C
Recirculating air stream:	5 100 Nm ³ /h
NaOH demand:	~5 k/kg (nitrogen eliminated)
Ammonium nitrogen (influent):	~2 000 mg/l
Guaranteed value (effluent):	150 mg/l

The exhaust vapour condensate, which is at a temperature of 60-80 °C, is conveyed into a container of 3 m³ volume. To prevent the emergence of foams, a defoaming agent, on a silicone base, is dosed onto the stripping input pipeline, which feeds the columns. The pH value is raised by the addition of NaOH. Air saturated with steam is fed countercurrently from the press room at a temperature of approximately 30 °C and with a waste water:air ratio of 1:1000. Neutralisation of the effluent does not occur immediately after the stripping, but only after the reconvergence with the other waste water streams. The exhaust air from the stripping is then conveyed through a biofilter system at a maximum rate of 122 400 m³/d. The reported alternative routes for disposal of the ammonia-laden air are incineration, catalytic oxidation and acid absorption.

Achieved environmental benefits

Removal of NH₃ from exhaust vapour condensates.

Environmental performance and operational data

Table 4.22 shows performance data for a winter and a summer month.

Table 4.22: Data of a stripping plant for ammonium (average values - daily mixed samples)

Parameter	February			July		
	Influent	Effluent	% increase/ decrease	Influent	Effluent	% increase/ decrease
pH value	7.6	12.1	-	5.7	12.5	-
Specific conductivity (mS/cm)	3.67	8.45	-	6.08	14.8	-
COD total (mg/l)	6 168	5 553	- 10	14 016	12 780	- 9
NH ₄ -N (mg/l)	647	64.3	- 90	931	95.4	- 90
<i>Source:</i> [130, COM 2005]						

Cross-media effects

These depend on how the exhaust air is treated.

Example plants

At least two rendering plants in Germany.

Reference literature

[29, Germany 2001], [62, Germany 2002].

4.3.4.2.2 Ammoniacal-N removal from rendering condensate by ammonia conversion

Description

Ammoniacal nitrogen can be removed from exhaust vapour condensates (EVCs) by ammonia conversion. Ammonia is conveyed with the EVCs into a washing tower (converter) in a countercurrent to a nitrous solution of 50-60 % strength. These react producing a solution of ammonium nitrate. The concentrated ammonium nitrate solution is pumped through a filter tower in the converter. The ammonium nitrate is extracted from the tower when the desired concentration has been reached. The exhaust vapours, now freed of ammonia, are then condensed in a condenser into acid exhaust vapours.

By adding urea, the ammonium nitrate solution gained in this way can be turned into a 28 % ammonium-nitrate urea solution, which can be used in agriculture as a high-nitrogen-ratio fertiliser.

For the operation of such a converter, it is a requirement that the exhaust vapours do not carry any solids. Cyclones or other suitable means of separation must therefore be installed upstream of the converters. Volatile carbon acids in the exhaust vapours are mainly caused by high temperatures (> 130 °C) during the drying process.

Achieved environmental benefits

Removal of ammoniacal nitrogen from the condensates produced from rendering.

Example plants

At least three rendering plants in Germany.

Reference literature

[29, Germany 2001], [62, Germany 2002].

4.4 Fishmeal and fish oil production

4.4.1 General information about the sector

On a global level in 2017, Europe produced 16 % of the world's fishmeal and 23 % of the world's fish oil. There are 29 fishmeal and fish oil installations in Europe [122, *European Fishmeal 2019*]. Fish-based marine proteins and oils provide a balanced amount of all essential amino acids, minerals, phospholipids and omega-3 fatty acids (DHA and EPA).

The production of fishmeal and fish oil is based on fresh landings of small, oily, short-lived fish species such as Blue Whiting, Capelin, Sand Eel, Norway Pout and Sprat which are subject to international quotas. Furthermore, a significant amount of the raw material is by-products (trimmings) from the fish processing or filleting industry. The filleting industry utilises between 40 % and 60 % of a herring or a mackerel and the remaining part of the raw material is, to the extent that is possible, transported and processed by fishmeal and fish oil factories. Several of the fishmeal and fish oil factories in Europe produce only from trimmings, while the rest are produced both from fresh landings and trimmings. The conditions and production processes of fishmeal and fish oil differ fundamentally from the fish processing industry.

It is expected that more by-products will be used in the coming years in the fishmeal and fish oil industry. The quality of the end product can vary in terms of having a lower protein content and increased level of minerals (ash) and small amino acids (e.g. glycine, proline, hydroxyproline) in comparison with products obtained from fresh fish [167, *Spain 2020*].

4.4.2 Applied processes and techniques

The raw material is basically composed of three major fractions: solids (fat-free dry matter), oil and water. During the production process, these three fractions are separated from each other. The processing of the raw material into meal and oil takes place in fully automatic closed systems from beginning to final product(s).

The raw materials used in the production of fishmeal and fish oil go through a process that consists of boiling, separation, evaporation, drying, cooling and milling, as shown in Figure 4.36.

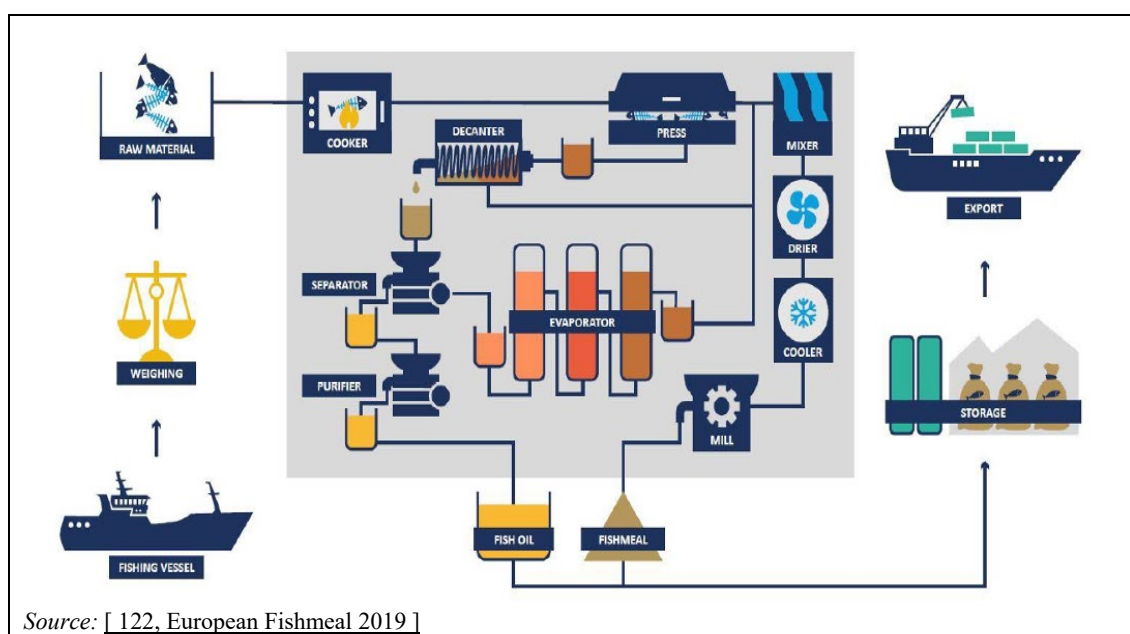

Figure 4.36: Processing steps of fishmeal and fish oil production

The raw materials delivered to fishmeal and fish oil factories are composed of direct landings from fishing vessels, trimmings/by-products from the fish processing industry and trimmings/by-products from the aquaculture industry. To optimise the quality of the final product, most of the fish supplied directly from fishing vessels is maintained in a chilled condition from the time it is caught until it is offloaded from the vessel. The parameter used to measure the freshness of the raw material is total volatile nitrogen (TVN). TVN is used as a quality parameter and process control and used in the contract with the supplier, as it relates to the quality of the end product. Hence there is an industry-driven financial incentive to keep TVN levels as low as possible.

A feature of the trimmings/by-product raw material is the remoteness of locations from which the material originates, which can make maintaining the quality of the raw material difficult as it is delivered to the plant in smaller consignments.

Raw material intake differs a little all over Europe as it depends on how the raw material arrives. It can be both by screw conveyers, lamella pumps, tipped from containers, bins, skips, bulkers or trucks or by pumping with water directly from the vessels. Common for all factories is that raw material is unloaded into enclosed hoppers or tanks.

After the raw material is unloaded and stored in a buffer silo, the raw material is fed into a cooker. The raw material is heated to 90-95 °C, which sterilises the fish, coagulates the proteins and disrupts the cell membranes, to facilitate the separation of the soluble fraction and the oil from the dry matter. The cooking temperature is controlled automatically to ensure correct cooking. This is done according to the veterinary requirements.

The cooked raw material is fed to a screw press, where much of the liquid is squeezed out to produce a liquid phase and a solid phase when using a two-phase decanter; in the case of a three-phase decanter, there is also an oil phase. Strainers are used before pressing to make optimal working conditions for the presses. Efficient pressing gives low fat levels in the product.

The press water is separated further in a decanter. The press water contains most of the oil from the fish and dissolved proteins, salts and fine particles. The liquid from the decanter is sent to separators, where the oil is removed and subsequently stored for export. A two-step separation is used for the extraction of fish oil: 1) extraction of oil from the soluble fraction by means of a first separator; 2) polishing of extracted fish oil by means of a second separator. All solids separated by this process are recovered.

The liquid that remains after the removal of the oil is the stickwater. This is fed to evaporators, where it is concentrated before being blended with the press cake during the drying stage. The stickwater contains both dissolved and undissolved proteins, residual oil, minerals and vitamins. To concentrate the stickwater and achieve a high concentration of dry matter, large quantities of water are removed by evaporation, which requires energy, and the resultant condensate has to be discharged. The industry currently uses various devices for evaporation and having an evaporator significantly reduces the environmental impacts of waste water on the receiving environment.

The purpose of the drying process is to convert the wet mixture of the press cake, decanter sludge and concentrated stickwater into a dry fishmeal. In practice, this means drying to a moisture content below 12 %, which generally may be considered low enough to inhibit microbial activity. This drying is done by heating the material to a temperature where the rate of evaporation of the water is considered satisfactory in order to avoid reduction of quality, especially of the protein.

The typical drying processes are indirect steam drying, vacuum drying, hot air drying and spray drying. Some plants may use more than one drying process. Good practice applied to the drying process involves sealing of equipment to avoid uncontrolled excess air ingress, control/removal of vapour steam and maintaining equipment under vacuum. After drying, the fishmeal is cooled by air. Air for cooling is treated to reduce odour emissions.

The fishmeal is ground to a specific particle size using hammer mills. After the milling, the meal is stored for export either as meal or pelletised. Air from the grinding/milling is treated to reduce odour emissions.

To remove undesirable substances, the oil-producing factories may pass the oil through a carbon-filter press. A scrubbing tower collects air and surplus vapour from the dryers and the heat exchanger and air suction vapour from the processing plant.

4.4.3 Current emission and consumption levels

4.4.3.1 Energy consumption

Energy is used for offloading, cooling, cooking, separating, evaporating and drying. Fishmeal plants do not refrigerate the raw materials, but the fishermen add ice directly to the fish at sea, and the plants also receive fishery by-products as frozen or iced products from the filleting industry.

Figure 4.37 shows data (from installations participating in the data collection, for the years 2016 to 2018) in relation to total specific net energy consumption in kWh/tonne of raw material at installation level, as well as the applied techniques to reduce energy consumption.



Figure 4.37: Specific net energy consumption (kWh/tonne of raw material) and applied techniques to reduce energy consumption in fishmeal and fish oil production (installation level)

Figure 4.38 shows data (from installations participating in the data collection, for the years 2016 to 2018) in relation to total specific net electricity and heat consumption in kWh/tonne of raw material at installation level.

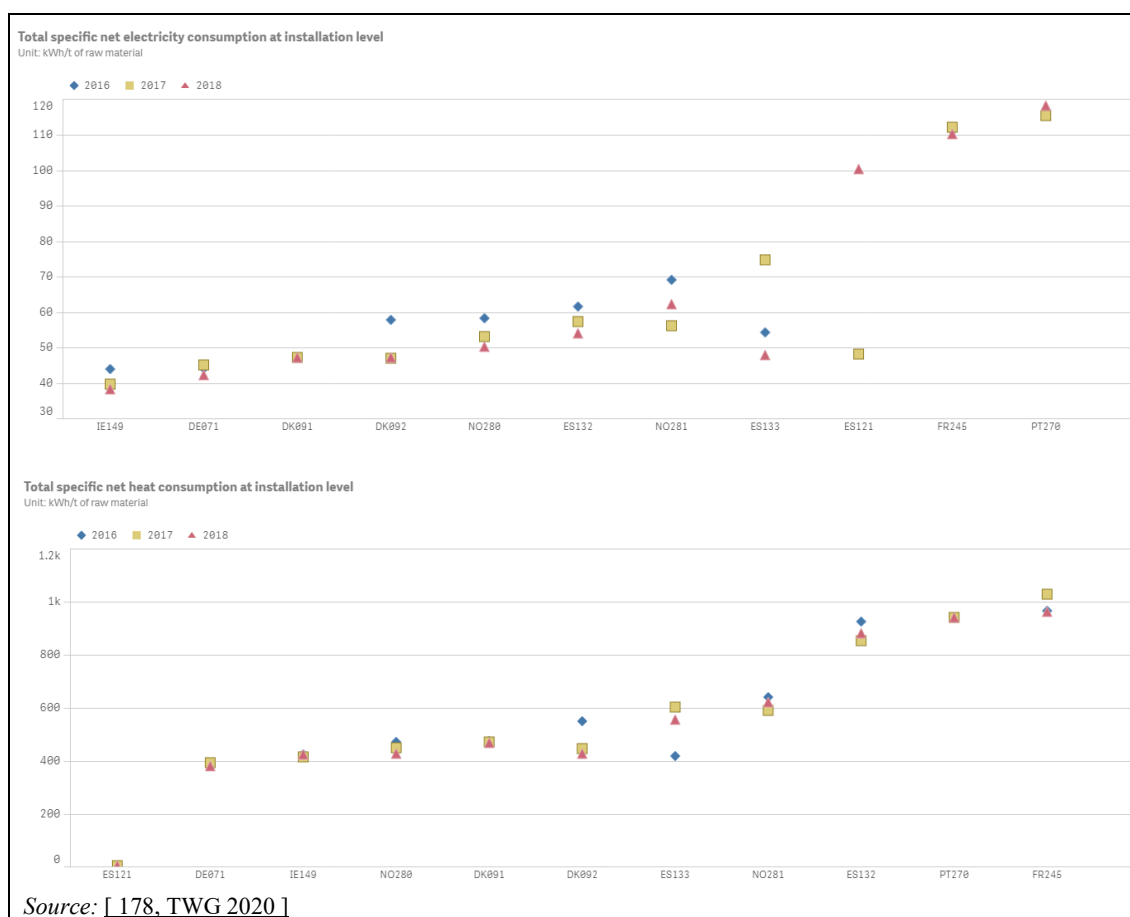

Figure 4.38: Specific net electricity and heat consumption (kWh/tonne of raw material) in fishmeal and fish oil production (installation level)

Figure 4.39 and Figure 4.40 show the specific net energy consumption (from installations participating in the data collection, for the years 2016 to 2018) in kWh/tonne of raw material in some processes in fishmeal and fish oil production.

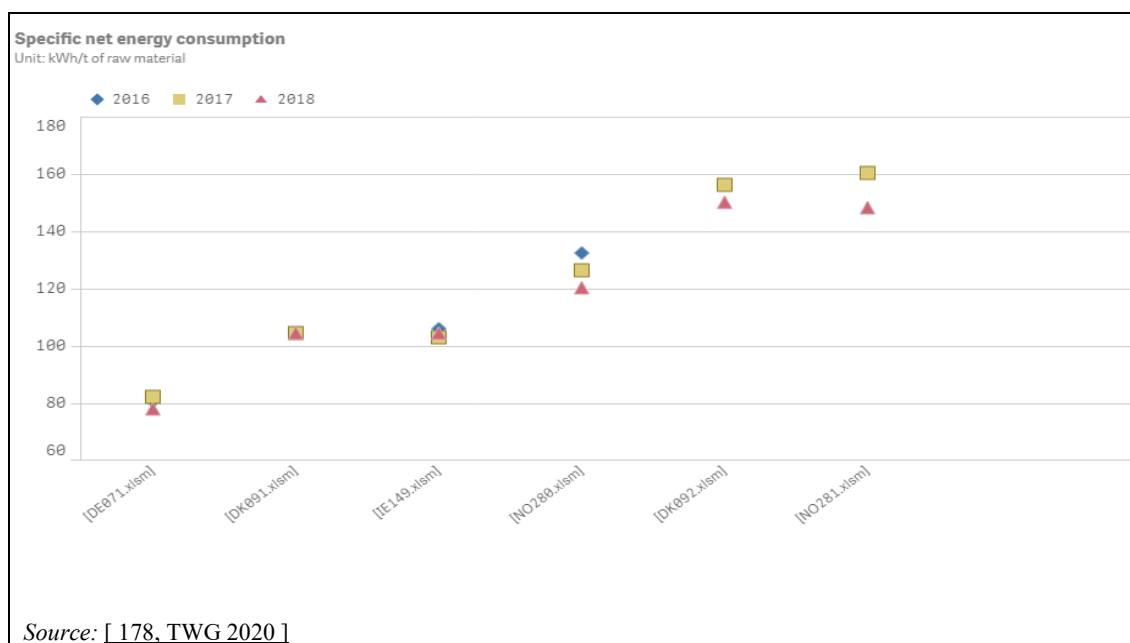

Figure 4.39: Specific net energy consumption (kWh/tonne of raw material) for cooking/sterilisation in fishmeal and fish oil production

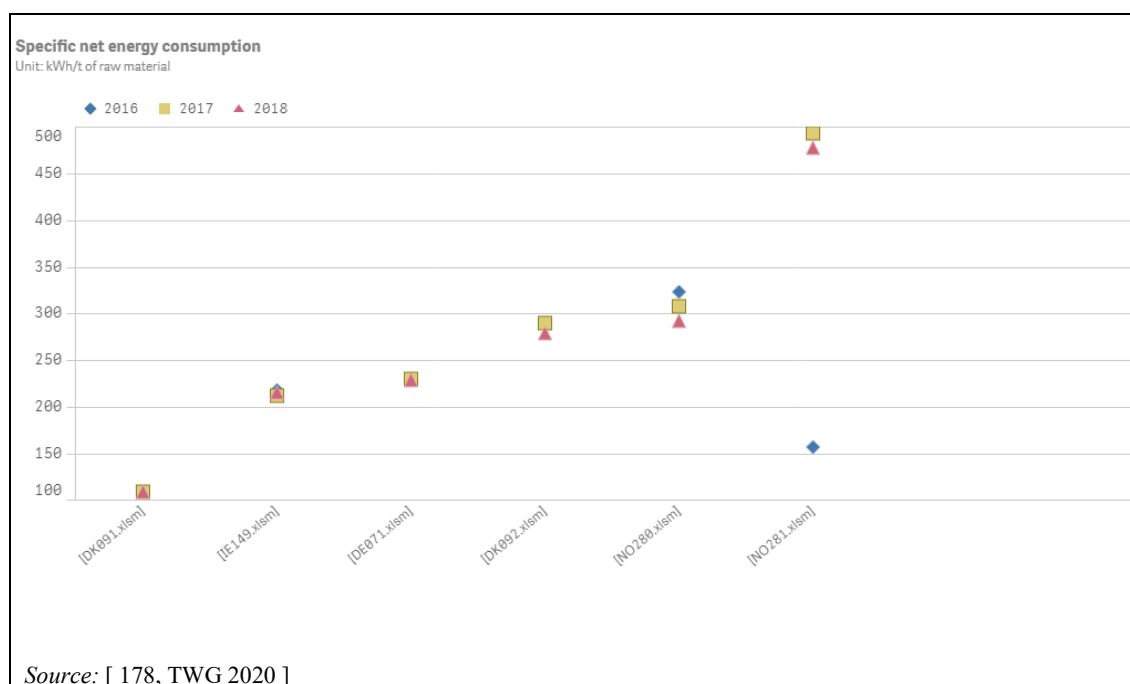

Figure 4.40: Specific net energy consumption (kWh/tonne of raw material) for drying in fishmeal and fish oil production

4.4.3.2 Water consumption

Fresh water is used in the boiling process, in the separators and to clean machinery and tanks using the cleaning-in-place (CIP) method. However, a number of installations use condensates as rinsing water for CIP. Seawater is used for cooling of waste water from the evaporators and other equipment which requires cooling. Seawater can be also used for cooling, scrubbing and condensing to liquid within the fishmeal production process and is also generally used directly for cooling excess air from meal cooling. Seawater is by far the biggest component of water consumption. However, local conditions mean that a few installations do not have access to seawater.

Figure 4.41 shows data (from installations participating in the data collection, for the years 2016 to 2018) in relation to total specific net water consumption in m³/tonne of raw material at installation level.

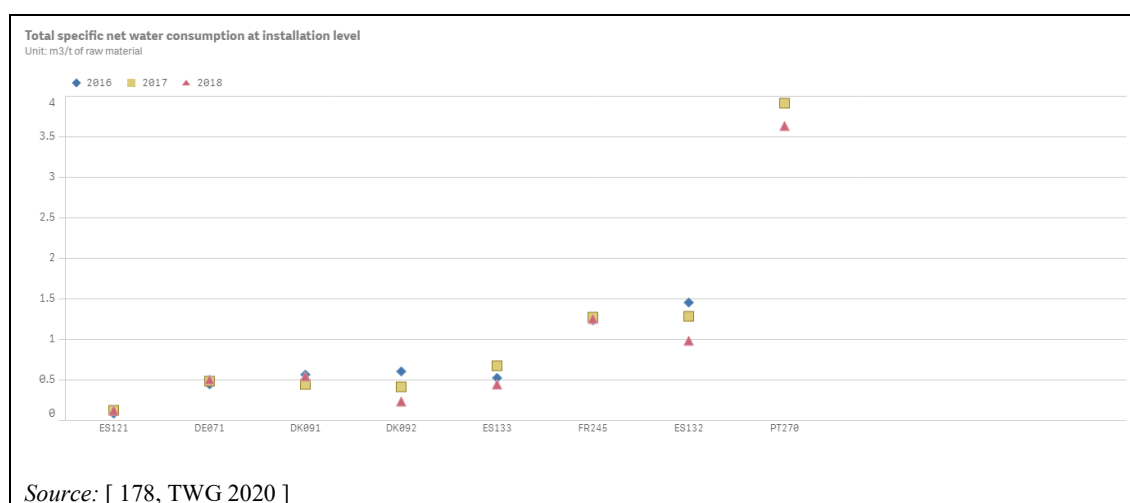

Figure 4.41: Specific net water consumption (m³/tonne of raw material) in fishmeal and fish oil production (installation level)

Figure 4.42 and Figure 4.43 show the specific net water consumption (from installations participating in the data collection, for the years 2016 to 2018) in m³/tonne of raw material for several specific processes in in fishmeal and fish oil production.

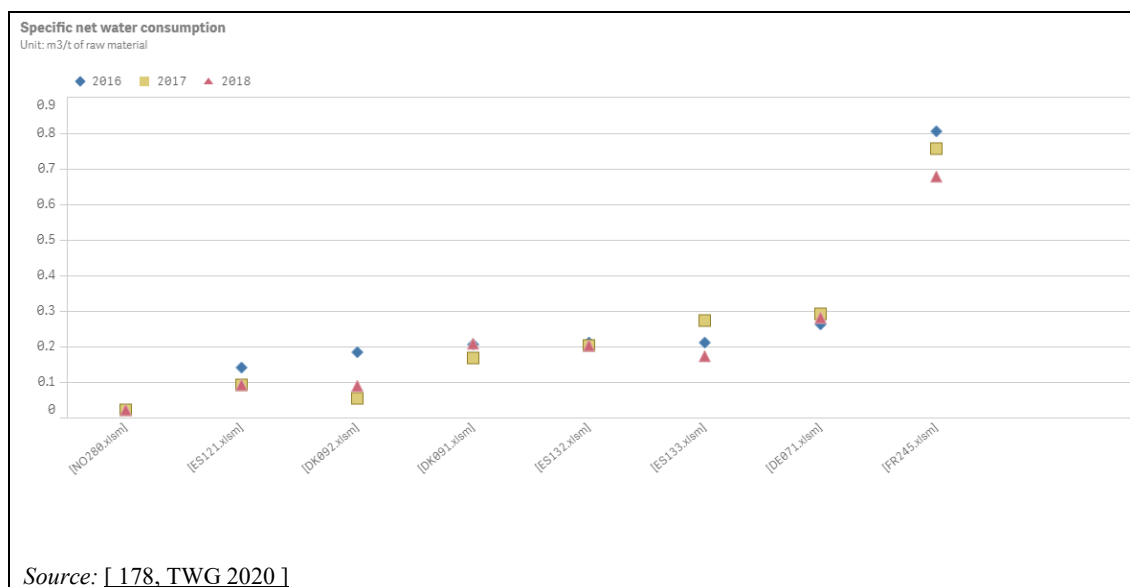

Figure 4.42: Specific net water consumption (m³/tonne of raw material) for boilers in fishmeal and fish oil production

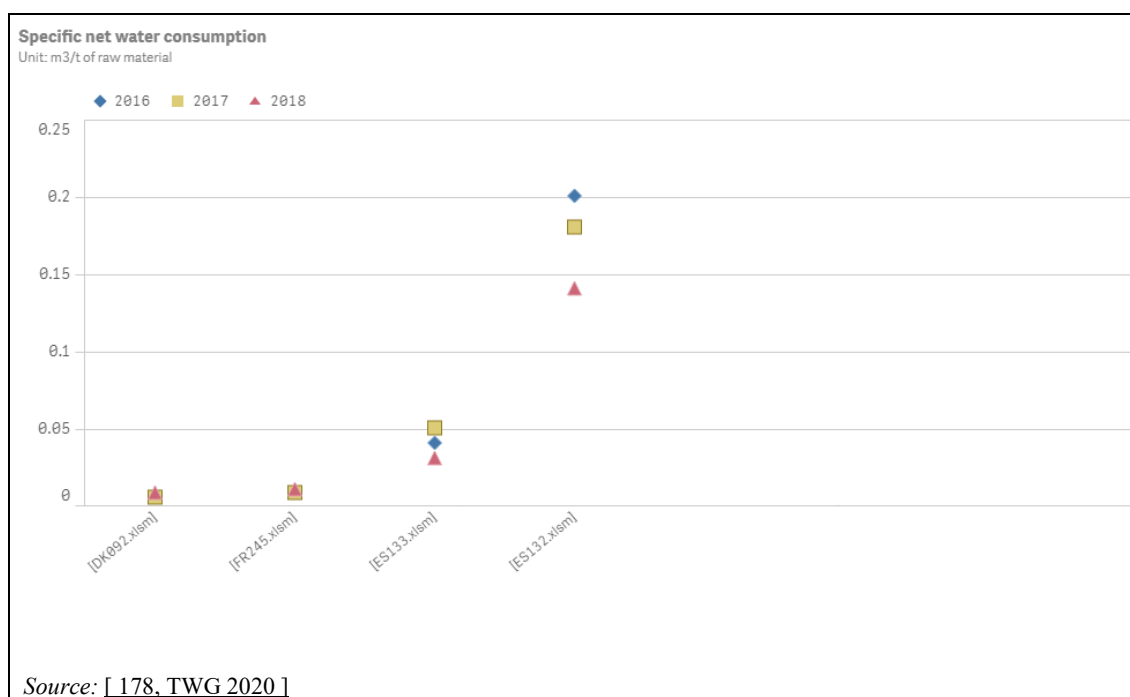

Figure 4.43: Specific net water consumption (m³/tonne of raw material) for vehicle washing in fishmeal and fish oil production

4.4.3.3 Emissions to water

The total waste water discharge of fishmeal and fish oil installations is generated from several processes, the water content extracted from the raw material and seawater used in scrubbing and cooling processes.

Figure 4.44 shows reported data (from installations participating in the data collection, for the years 2016 to 2018) on specific waste water discharges in m³/tonne of raw material from fishmeal and fish oil production and all types of discharges. The applied techniques for reducing water consumption are also shown.

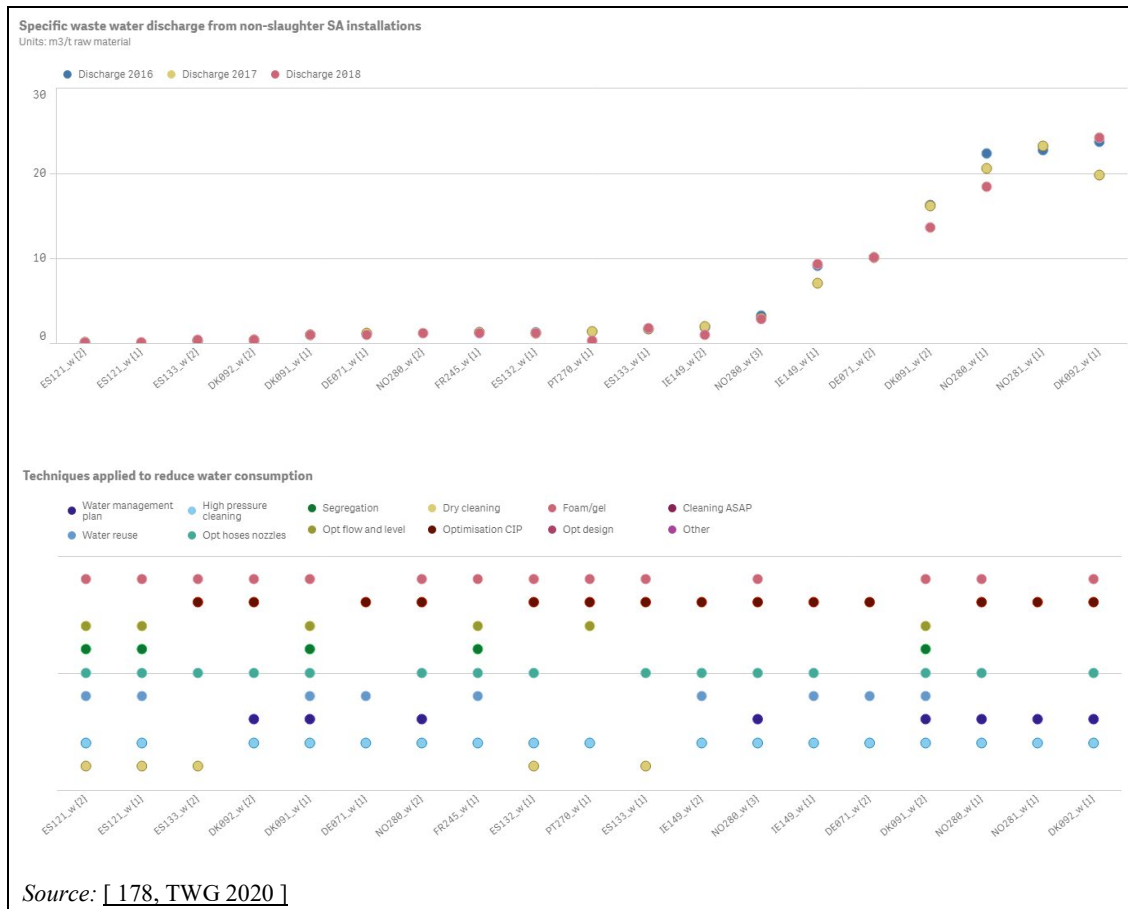

Figure 4.44: Specific waste water discharge (m³/tonne of raw material) and applied techniques for reducing water consumption in fishmeal and fish oil production for all types of discharges

Waste water contains organic matter, suspended solids, nitrogen, phosphorus, dimethylamine and trimethylamine. Sodium hydroxide and sulphuric acid are used as detergents.

Seawater is used as cooling water in the scrubbers and in evaporators and for scrubbing the air before incineration.

4.4.3.4 Emissions to air

Emissions to air contain dimethylamine, trimethylamine and some hydrogen sulphide.

Odour

Malodorous air is produced during offloading, drying and from production rooms. It is caused by ammonia and amines in the air and water.

Figure 4.45 and Figure 4.46 show reported data (from installations participating in the data collection, for the years 2016 to 2018) for channelled emissions of odour, as well as the applied abatement techniques, from fishmeal and fish oil production.

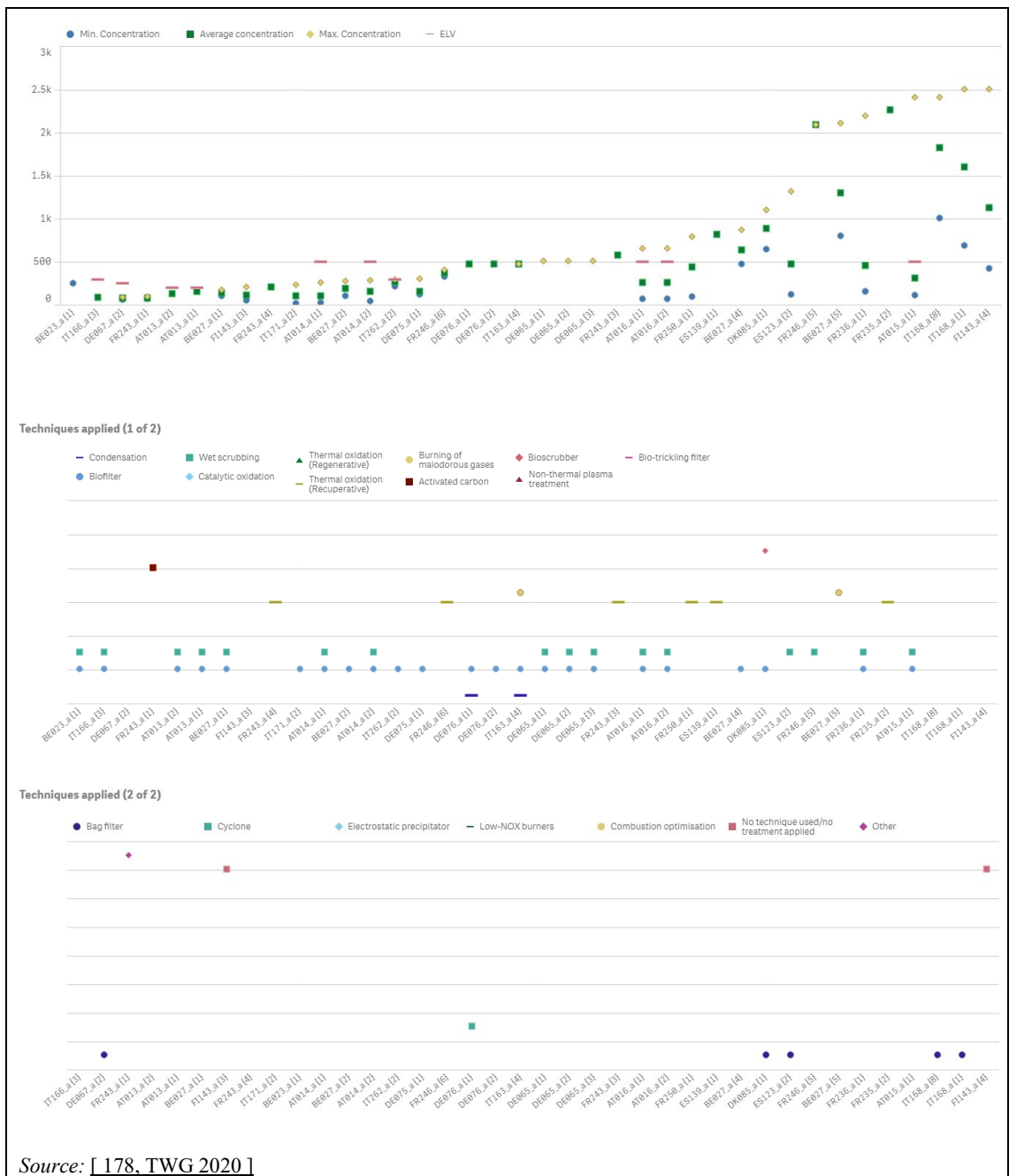

Figure 4.45: Odour emissions (ou_E/m^3) and abatement techniques from fishmeal and fish oil production (Part 1 of 2)

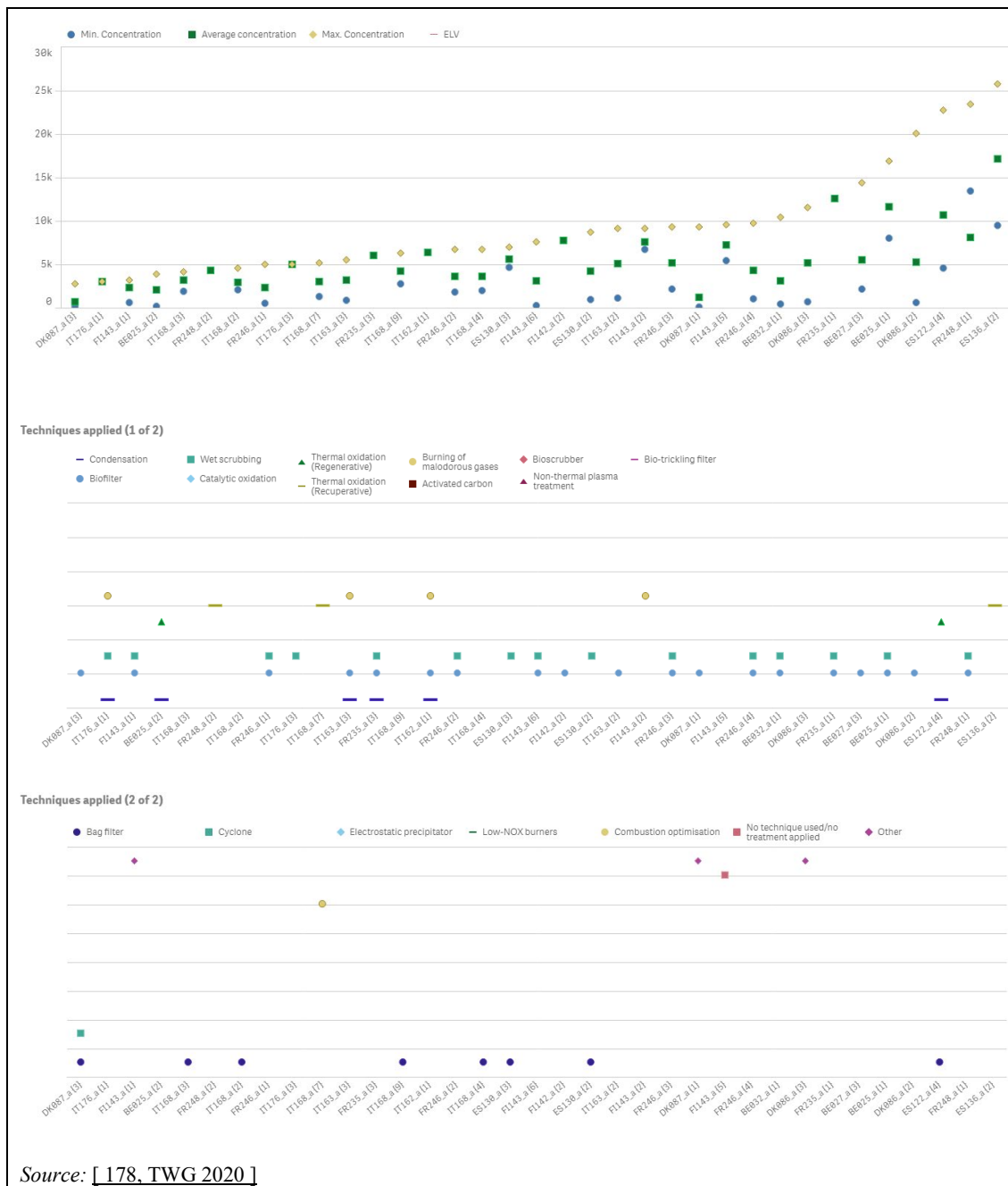

Figure 4.46: Odour emissions (ouE/m³) and abatement techniques from fishmeal and fish oil production (Part 2 of 2)

TVOC

Figure 4.47 shows reported data (from installations participating in the data collection, for the years 2016 to 2018) for channelled TVOC emissions to air, as well as the applied abatement techniques, from fishmeal and fish oil production.

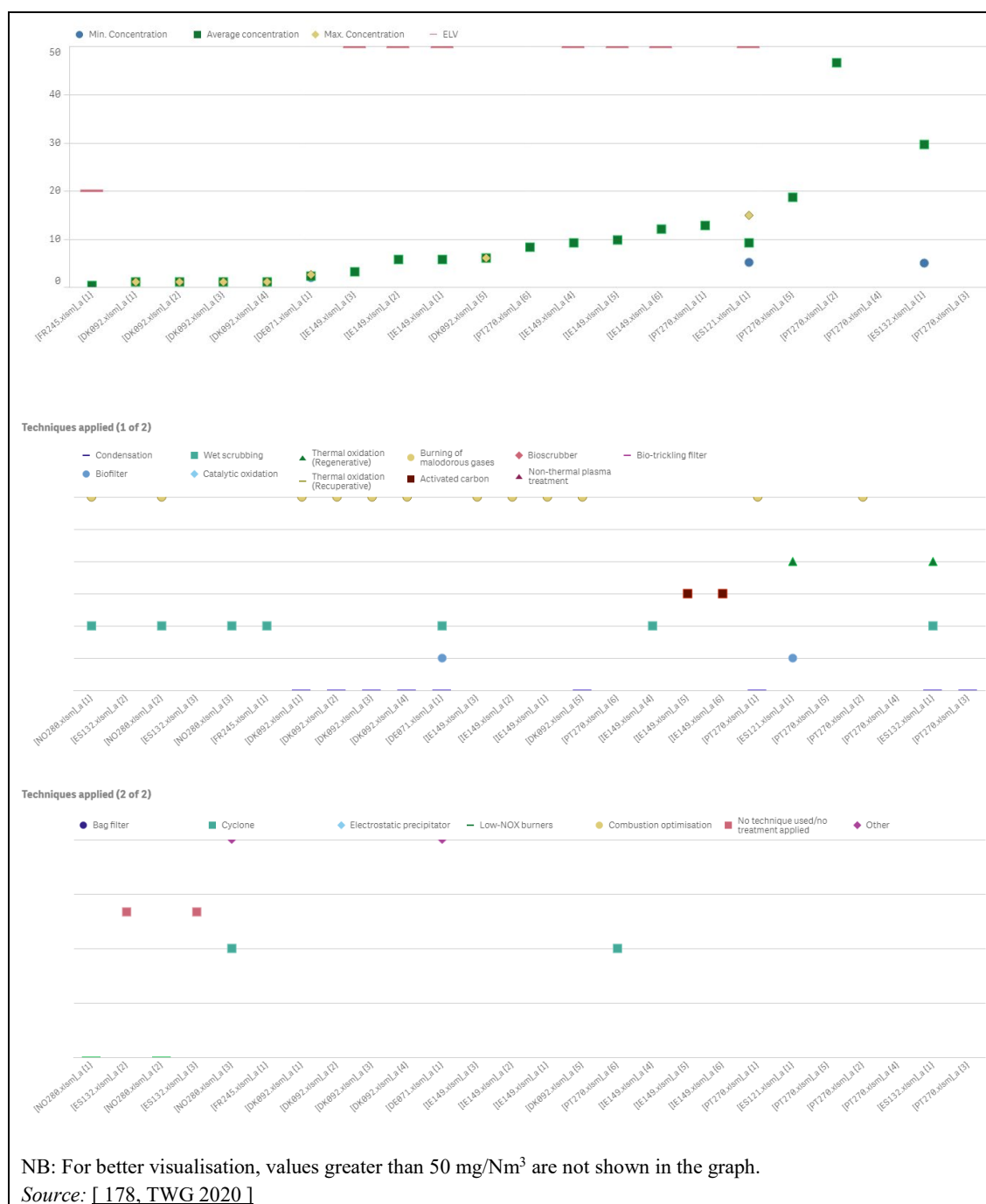

Figure 4.47: TVOC emissions to air (mg/Nm³) and abatement techniques from fishmeal and fish oil production

NH₃

Figure 4.48 shows reported data (from installations participating in the data collection, for the years 2016 to 2018) for channelled NH₃ emissions to air, as well as the applied abatement techniques, from fishmeal and fish oil production. The reported data refer mostly to emission points from two installations.



Figure 4.48: NH₃ emissions to air (mg/Nm³) and abatement techniques from fishmeal and fish oil production

4.4.3.5 Noise

Offloading is a noisy operation, due to the use of pumps. The use of submersible fish pumps, such as those used on fish farms, causes less noise. These have the additional advantage of being less damaging to the fish. Their disadvantage is that they need a lot of water and this has to be treated as waste water [71, IFFO 2002].

4.4.4 Techniques to consider in the determination of BAT

4.4.4.1 Techniques to increase energy efficiency

4.4.4.1.1 Use of heat from vapour from drying fishmeal in a falling film evaporator, to concentrate stickwater

See also Section 2.3.4.1.4.

Description

The waste heat from the drying of press cake, grax and evaporated stickwater is used in a falling film evaporator, for the concentration of stickwater, to form evaporated stickwater.

Technical description

The waste heat from the drying of press cake, grax and evaporated stickwater can be used in a falling film evaporator, for the concentration of stickwater, to form evaporated stickwater.

In the installation which reported this technique, the specification for the air/vapour mix from the dryer is a temperature of at least 87 °C and for the mix to be saturated with vapour. A 1:1 mix of air:vapour gives an acceptable energy source with suitable heat transfer properties.

Figure 4.49 and Figure 4.50 are schematic representations of two different evaporator types. The evaporator shown in Figure 4.49 is an older self-circulating evaporator, where the stickwater/evaporated stickwater circulates up through the heat exchanger as a result of heating and vapour formation. This circulation is not shown in the figure. It shows the main steam and liquid flows. The seawater flow through the barometric condenser is typically in the order of 200 m³/h, while the evaporation rate is about 5-20 m³/h. The self-circulating evaporator is heated with steam from the factory boiler. This is a very common evaporator type in the fishmeal industry. This type of evaporator typically contains very large quantities of liquid and uses high temperatures in its first stage, where boiling temperatures of 120-130 °C are normal. The large quantities of liquid lead to long average retention times and this, together with the high boiling temperatures, causes the stickwater/evaporated stickwater to be exposed to a severe heat load.

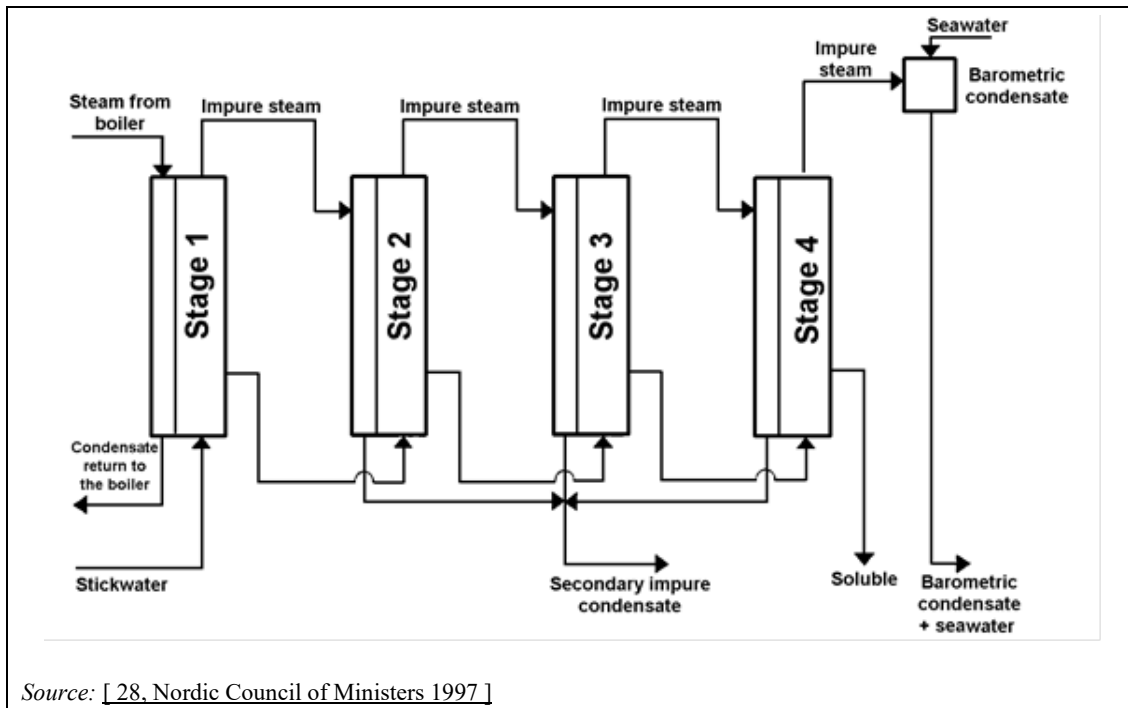

Figure 4.49: Schematic representation of a four-stage self-circulating evaporator

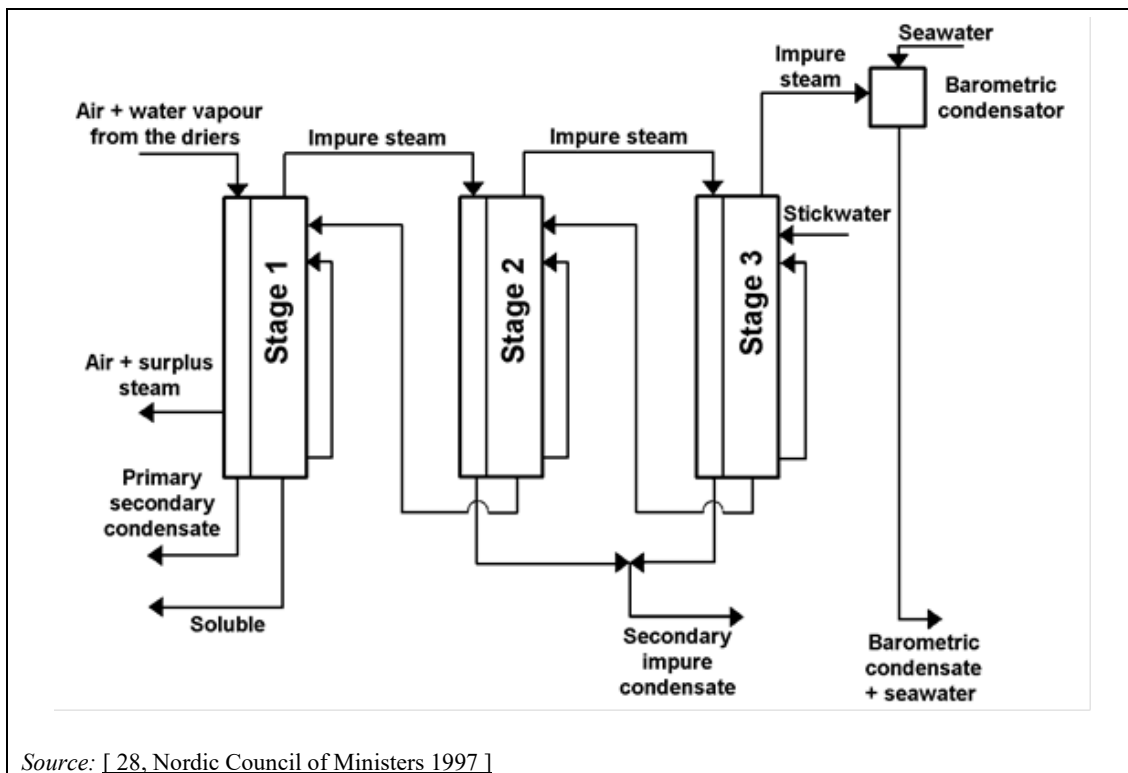

Figure 4.50: Schematic representation of a falling film surplus heat evaporator

The evaporator shown in Figure 4.50 is a falling film evaporator. It shows the main steam and liquid flows. The seawater flow through the barometric condenser is typically around 250 m³/h, while the evaporation rate is about 10-30 m³/h. The stickwater/evaporated stickwater is recirculated and then pumped to the top of the heat exchanger. Here, the liquid is dispersed into a large number of tubes where it runs as a film down the inner walls of the tubes to the bottom of the heat exchanger. Part of the liquid evaporates. At the bottom of the evaporator, the liquid and vapour mixture is separated. This evaporator type is typically heated with surplus steam from the

dryers but it can also be heated with steam from the boiler. The evaporator typically contains very small quantities of liquid and this results in short average retention times. Normally, relatively low temperatures, typically 55-60 °C in stage 1 and 40-50 °C in the last stage, are used when the evaporator is supplied with surplus vapour from the normal atmospheric pressure dryers. The product is submitted to a much lower temperature in this type of evaporator than in the self-circulating evaporator, so it has a better quality.

In the falling film evaporator, a correlation has been reported between the performance of the evaporator and the amount of carry-over in the impure condensate. It is, therefore, possible to reduce carry-over by controlling the output of the evaporator. The carry-over reported at moderate output from a falling film evaporator is reported to be slightly lower than the best results from a self-circulating evaporator. No severe boiling-over was observed from the falling film evaporator.

A self-circulating evaporator, in relation to a falling film evaporator, contains very large quantities of stickwater and evaporated stickwater which remain in the evaporator during temporary stoppages. As stickwater and evaporated stickwater are very unstable, even very short stoppages can result in changes in the product great enough to have a negative effect on the discharge from the evaporating process on restarting the evaporator.

The large volume of the self-circulating evaporator requires very large amounts of water and NaOH for cleaning, which subsequently leads to large amounts of waste water.

It is claimed that use of falling film evaporators in the evaporating process of the fishmeal industry improves the product, as well as reducing the environmental impact. The quality of evaporated stickwater from a falling film evaporator is reported to be considerably higher than that of evaporated stickwater from a self-circulating evaporator, due to the much lower temperatures to which the product is submitted in the falling film evaporator.

Achieved environmental benefits

Reduced energy consumption, due to using the vapour from the dryer and by operating at lower temperatures. Less water contamination by product loss and cleaning substances than when a self-circulating evaporator is used.

Environmental performance and operational data

In an example plant, the secondary impure condensate received little contamination due to boiling-over from the self-circulating evaporator, until unidentified technical problems occurred in the evaporator. In spite of this, the results of a statistical analysis suggest that the phosphorus content had a significant influence on the degree of pollution in the condensate. A similar effect was not seen for the secondary impure condensate of the falling film evaporator, even though it often contained as much phosphorus as the samples from the self-circulating evaporator.

The quality of the evaporated stickwater from a falling film evaporator is considerably higher than that of evaporated stickwater from a self-circulating evaporator, because of the much lower temperatures to which the product is submitted in the latter. The fishmeal extracted from the press cake, grax and evaporated stickwater, is also consequently of a higher quality.

Cross-media effects

Seawater is discharged at approximately 10-40 °C.

Technical considerations relevant to applicability

Not applicable in fishmeal and fish oil factories with mechanical vapour recompression evaporators [156, TWG 2019].

Economics

No information provided.

Driving force for implementation

Reduced energy consumption and improved product quality.

Example plants

A fishmeal and fish oil factory in Denmark.

Reference literature

[28, Nordic Council of Ministers 1997], [89, Nielsen E.W. 2001], [156, TWG 2019].

4.4.4.2 Techniques to reduce emissions to air

4.4.4.2.1 Use of fresh low-total-volatile-nitrogen (TVN) feedstock

See also Section 2.3.2.6.

Description

Minimisation of the TVN of the feedstock by storing the fish in the fishing vessels at low enough temperatures and for the shortest time possible.

Technical description

A feature of the trimmings/by-product raw material is the remoteness of locations from which the material originates, which can make maintaining the quality of the raw material difficult as it is delivered to the plant in smaller consignments.

Fish can deteriorate under the anaerobic conditions present during storage on the fishing vessel and in the raw material silos in the factory. The deterioration causes the formation of a large number of strong-smelling compounds. Besides NH₃, TMA and other volatile basic compounds, various volatile sulphur compounds, such as mercaptans and the highly toxic and strong-smelling H₂S gas, are formed.

Achieved environmental benefits

Reduced nitrogen and sulphide content and consequently reduced odour emissions during storage, processing and waste water treatment.

Environmental performance and operational data

A decrease in raw material quality (increase in TVN) results in a considerable increase in the levels of the nitrogen compounds evolved. It is reported that statistical analysis shows that even with low concentrations of phosphorus, e.g. from over-boiling, much larger increases in condensate nitrogen levels were recorded than expected from just a consideration of the nitrogen and phosphorus content of the stickwater and evaporated stickwater.

Several investigations have been carried out on the deterioration of the raw material and on odour emissions from fishmeal factories. The investigations included examinations of the odour emitted during the unloading, transport, storage and processing of industrial fish in relation to the freshness/quality of the raw material. Plots of the raw material TVN contents against time give almost straight lines which have a strong dependence on the storage temperature. Several investigations have shown that the rate of TVN formation roughly doubles for each 6 °C temperature rise.

Investigations indicate that H₂S formation starts at a raw material TVN content of approximately 50-100 mg N/100 g of fish. H₂S is released from the fish during mechanical handling. It has been shown that at both 6 °C and 12 °C an exponential decrease in the H₂S content (the released amount) takes place. It has also been shown that extending the storage by 4 to 5 days results in roughly a tenfold increase in odour, irrespective of the temperature.

To summarise, the results of the odour measurements show that the higher the storage temperature, the faster the odour development and the stronger and more unpleasant the odour is, at an equal odour concentration. That is to say, odour formed at high temperature has a more powerful and worse smell than the same 'odour quantity' formed at low temperature.

Minimising the TVN at the fishmeal and fish oil processing installation, therefore, depends on the fish being stored in the fishing vessels at low enough temperatures and for the shortest time possible, to minimise degradation and the formation of strong and intensely malodorous substances.

Fishmeal and fish oil processors do not generally refrigerate raw materials, but ice is added on the fishing vessels. The amount depends on the temperature of the seawater and on how long the fish have to be stored on the boat before landing. In the late summer period, up to 25 % ice can be added to the fish; in the winter, 10 % is considered to be sufficient. On average, 15 % ice is added to all fish caught. To cool the fish down to 0 °C, ice is added at a ratio of 1.25 % by weight of fish caught. For example, if the temperature of the fish is 4 °C, then $4 \times 1.25 \% = 5 \%$ by weight of ice is added, i.e. 5 t ice/100 t fish. If the temperature is 16 °C then $16 \times 1.25 = 20$ t ice/100 t fish is added. If the fish has to be stored for longer than 1-2 days then more ice is required to keep the temperature down to 0 °C. The energy consumption for producing 1 tonne of ice is 60 kWh. The average energy consumption, per tonne of industrial fish, of adding 0.15 tonne of ice would be 9 kWh. The addition of ice to the fish means that more energy must be used to remove the water, which in turn has to be treated in a WWTP.

Moreover, another practice is the addition of an acid (e.g. acetic acid) to the raw materials to reduce their spoilage rate.

The use of fresh raw material leads to the production of a higher quality product, as well as a reduction in odour and waste water treatment problems.

It is reported that it is not possible to totally avoid odours, even by using fresh materials, so the use of abatement techniques will always have to be considered.

Cross-media effects

None reported.

Technical considerations relevant to applicability

Applicable in all fishmeal and fish oil processing plants.

Economics

There are economic advantages associated with the production of a higher quality product from fresher, i.e. lower TVN, raw material.

Driving force for implementation

Reduced odour problems during storage, processing and waste water treatment and improved product quality.

TVN is used as a quality parameter and process control and used in the contract with the supplier, as it relates to the quality of the end product.

Example plants

Danish fishmeal factories.

Reference literature

[28, Nordic Council of Ministers 1997], [92, Minck F. 2002], [156, TWG 2019].

4.4.4.2.2 Incineration of malodorous air, with heat recovery

See also Sections 2.3.8.2.13 and 2.3.8.2.14.

Technical description

An installation has been described where 80 000 m³/h of air is incinerated in each of three incinerators. The majority of the air is from the press cake, grax and evaporated stickwater dryer. Other sources include air from offloading, which contributes about 5 000 m³/h. The air is passed through a scrubber before it is incinerated and the liquid effluent from the scrubber is treated in a WWTP.

Achieved environmental benefits

Odour abatement of 99.5 %.

Environmental performance and operational data

It is reported that it is impossible to avoid malodorous air during the production of fishmeal and fish oil, even if fresh ingredients are used. Malodorous emissions are produced during drying and evaporation. Those associated with the raw material can be reduced if the fish is processed fresh.

The inlet air is passed through one of three ceramic heat exchangers at 40-50 °C and the outlet air is passed through one of the other two at a temperature of 90-100 °C. The air is forced through the incinerator by suction. The direction of the flow is changed about every 30 seconds, so that all three heat exchangers operate in the cycle.

When the plant is running at a maximum fish throughput capacity, i.e. 250 t/h fish, the dryers generate 50 t of dry air and 50 t of water vapour. Most of the water vapour condenses in the waste heat evaporator.

The incineration conditions are 850 °C for 1 second.

Non-condensable gases can reportedly be destroyed by increasing the temperature of the ceramic incinerator. It has been stated that using scrubbers with seawater will only reduce the odour problem by 50 %.

Cross-media effects

High energy consumption, i.e. 1 m³ of natural gas per tonne of fish treated. It is reported that 90-95 % of the heat is recovered and used to heat air.

Technical considerations relevant to applicability

Applicable in fishmeal and fish oil processing factories where odour problems cannot be eliminated.

Economics

The investment costs are reported to be EUR 10 000-15 000/1 000 m³/hr (costs in 2001).

Driving force for implementation

Odour reduction.

Example plants

A fishmeal and fish oil factory in Denmark.

Reference literature

[47, Nielsen E.W. 2001], [48, Nielsen E.W. 2001], [92, Minck F. 2002], [102, The Netherlands 2003].

4.5 Gelatine manufacturing

4.5.1 General information about the sector

The gelatine industry is represented by the Gelatine Manufacturers of Europe Association (GME), which has 11 members and 21 gelatine production units (not all within the scope of the SA BREF), i.e. 2 in Belgium, 3 in France, 6 in Germany, 2 in Italy, 2 in Spain, 1 in the UK, 1 in Sweden, 3 in the Netherlands and 1 in Slovakia. In addition to these gelatine plants, there are three bone degreasing plants in France, Germany and the Netherlands, delivering bone chips to the gelatine plants (thus considered part of gelatine manufacturing). In the year 2018, they produced around 135 000 tonnes of gelatine (including hydrolysed collagen). The industry employs approximately 2 500-3 000 people. There is one other gelatine production plant in Poland, and two other bone degreasing plants in France and Ireland, operated by non-GME members [177, GME 2019], [204, TWG 2021].

Five gelatine installations and one bone degreasing plant, covered by the scope of the SA BREF, participated in the data collection. Installations DE084 and SK192, which are outside the scope of the SA BREF, also participated in the data collection.

Market and/or product changes are expected in the sector, with possible consequences for operating conditions. In particular, the need to switch from one raw material to another has been reported. For instance, the collagen peptides market is increasing and some sites may switch from gelatine production to collagen peptides [207, TWG 2023].

4.5.2 Applied processes and techniques

Gelatine is natural, soluble protein, gelling or non-gelling, obtained by the partial hydrolysis of collagen produced from bones, hides and skins, tendons and sinews of animals (including fish and poultry) [15, COM 1999].

The raw materials intended for the manufacturing of gelatine and collagen peptides are sourced from [191, GME 2020]:

- pig skin (conventional and organic – as by-product from the meat industry);
- bovine hide – as by-product from the leather or meat industry;
- bovine bone – as by-product from the meat industry;
- pig bones – as by-product from the meat industry;
- fish skin – as by-product from fish products.

All raw materials are fit for human consumption and have been approved ante- and post-mortem by veterinarian authorities. Several sites in Europe are producing gelatine from more than one type of raw material.

Gelatine is used in a diverse selection of industries (e.g. food industry, pharmaceutical industry, photographic industry) and products (e.g. powder gelatine, leaf gelatine, technical gelatine). The majority of gelatine produced is edible and pharmaceutical gelatine. It is also used in the photographic industry, in both films and paper. Technical gelatine is used in cosmetics and micro-encapsulation (carbon paper) for example.

The production of edible gelatine and collagen peptides should comply with European legal requirements, e.g. on rules for food of animal origin, microbiological requirements or medicinal products for human use.

Processed animal protein (PAP) is produced from the removal of residual flesh from the bones. Grease is used in pet food and as rolling oil in the ferrous metal finishing industry. Other PAPs

and fats may derive from gelatine production depending on the raw material used, which contribute to the natural cycle.

Sludge from the waste water treatment after both the pretreatment of bones and gelatine production may be used for landspreading, depending on soil requirements. The sludge may need to be mixed with other substrates. It may also be used as a substrate for biogas production depending on the process.

4.5.2.1 Description of the main gelatine manufacturing processes

There are several processes for the production of gelatine and/or collagen peptides. These depend to some extent on the raw materials used, although after the de-fatting and demineralisation of bones and the acid treatment of pig skins, the gelatine extraction steps in some of the processes using bones hides and pig skins are very similar. The main gelatine manufacturing processes are summarised in Figure 4.51 and the individual process steps are described below.

Flow diagrams for the manufacturing of gelatine produced from pig skins, hides, bones and fish skins are shown in Figure 4.53, Figure 4.54, Figure 4.55, Figure 4.56 and Figure 4.57.

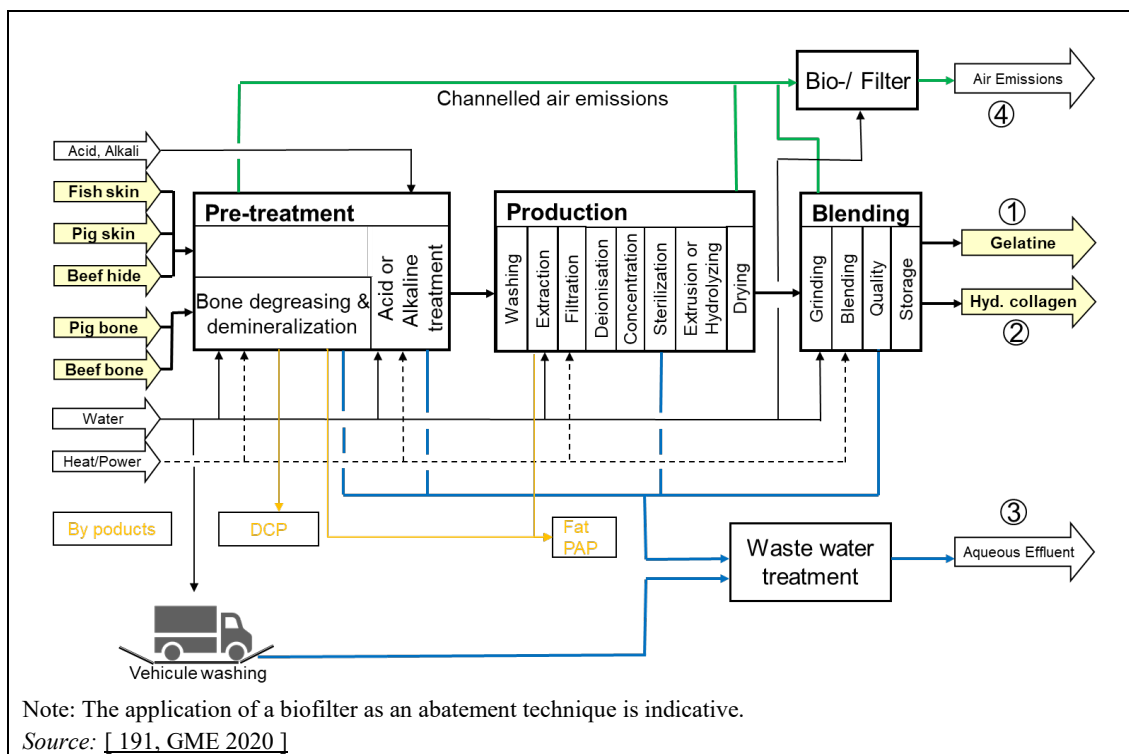

Figure 4.51: Production of gelatine and/or collagen peptides (installation level)

The unit operations are described below.

A Degreasing

The untreated bones contain a large amount of meat, soft tissue and fat, which have to be removed. A typical example of the composition of a batch of fresh bones is: 46 % water, 15 % fat, 19 % protein and 20 % minerals.

The bones are crushed in a pre-breaker to a maximum particle size of 20 mm diameter, before being degreased, using hot water, at a temperature of 75-90 °C, for 15-30 minutes. A continuous process has been reported, using a steam-jacketed and steam-heated screw conveyor. The turbulent action of the hot water and the sliding and rubbing of the crushed bone loosens the meat

and other soft tissue from the bone. The contents of the degreasing vessel are separated to give hard bone, sinew (soft bone) and liquids containing tallow and water.

The hard bone may be washed using hot water, to give a final moisture content of around 10 %. The sinew may be pressed to remove fat and water before being dried with the hard bone to give a final moisture content of 14 %. Drying at 85 °C takes 45 minutes [44, Croda Colloids Ltd 2000].

Alternatively, the sinew and liquid stream may be separated into a liquid stream containing tallow and water using a decanter or tricanter system and the sinew stream can then be dried in a rotating disc dryer, to give a moisture content well below 10 %. The product temperature reached in the dryer is about 110 °C, for at least 45 minutes [65, GME 2002].

The dried bone and sinew are sieved at 2 mm and 5 mm to give bone meal (< 2 mm fraction), intermediate bone pieces (2-5 mm fraction) and degreased gelatine bone/sinew (> 5 mm fraction).

The tallow/water mix is separated using centrifuges to give purified tallow and process water. The liquids are maintained at a temperature of 85 °C for 30 minutes during separation.

Fine solids removed from the liquid during separation and fine solids from the pressing of the sinew are combined and dried to give a moisture content typically < 10 %. The product temperature achieved in the dryer is around 110 °C for at least 45 minutes.

Cyclones are used to remove the air and to separate the fines from the larger particles destined for the gelatine manufacturing.

Bone chips are graded by density, using a hydrocyclone, because high-density bones require more processing than low-density bones, both to demineralise and to extract the gelatine. They are then dried in a band oven, with a starting air temperature of around 350 °C and an exit temperature of 150 °C. The chips are only in contact with the hot air for a short time and they are also cooled by the evaporation of the water, so their temperature will not normally exceed 85 °C. The drying time varies from 20 to 60 minutes. The dried bones are then classified by size, firstly using rotating or vibrating sieves, normally at 2-5 mm, and then using a densimetry table, which comprises an inclined screen with an upward air-draught onto which the bone chips are dropped.

The amount of dried degreased bone chips obtained from 1 kg of bone is usually about 200 g.

If hides or skins are used this pretreatment stage is not required.

B Demineralisation

The demineralisation process is the removal of the inorganic component, which comprises mainly natural phosphates and calcium carbonate. The defatted bones are placed in a strong HCl solution at pH 1-2, where the tricalcium phosphate is converted into the soluble monocalcium salt, which is run-off in solution, for later conversion to dicalcium phosphate, soluble calcium chloride and CO₂. The chemical reaction with HCl is shown:

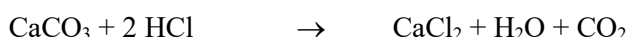
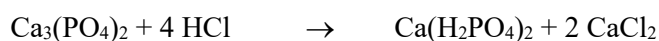

For 1 000 kg of degreased bone, containing 8 % water and of which 63 % comprises 7 % CaCO₃ and 56 % Ca₃(PO₄)₂, approximately 7 700 litres of 4 % HCl is required, for complete conversion.

The solid residue, which is known as ossein, is used in gelatine manufacturing. The ossein production process may take several days depending on the nature, size and density of the raw material. Several pits, e.g. six, sit in series, containing ossein, at various stages in the process. Fresh HCl at a concentration of, for example, 3.5 % is added to the pit containing the ossein which has been treated for the longest time. After approximately 24 hours, this acid is pumped to the pit containing the second-oldest ossein, whilst the acid from this is pumped to the pit containing the

third-oldest ossein. The process continues by this batch countercurrent action. In this way the 'newest' liquor, with the highest acid concentration and the lowest concentration of monocalcium salt is extracting the salt from the ossein with the lowest available yield. The 'oldest' liquor, with the lowest acid concentration, i.e. about 0.5 %, is extracting the salt from the ossein which has the most salt to give up. The process can be helped by air agitation. The process is illustrated in Figure 4.52.

Each reactor tank in the process typically contains a batch of 20-50 tonnes of bone chips, but smaller tanks may also be used. The tank height may be about 7 metres and the diameter about 3.5 metres. New reactors are usually made from plastic-coated steel. For a system with four reactor vessels, 200 tonnes of degreased bone chips can be treated in 4 days, in four batches of 50 tonnes. To demineralise these, approximately 1 540 m³ of 4 % HCl is required. For an installation operating at an efficiency of approximately 90 %, this requirement increases to approximately 1 710 m³ in 4 days or about 17.8 m³ l/h.

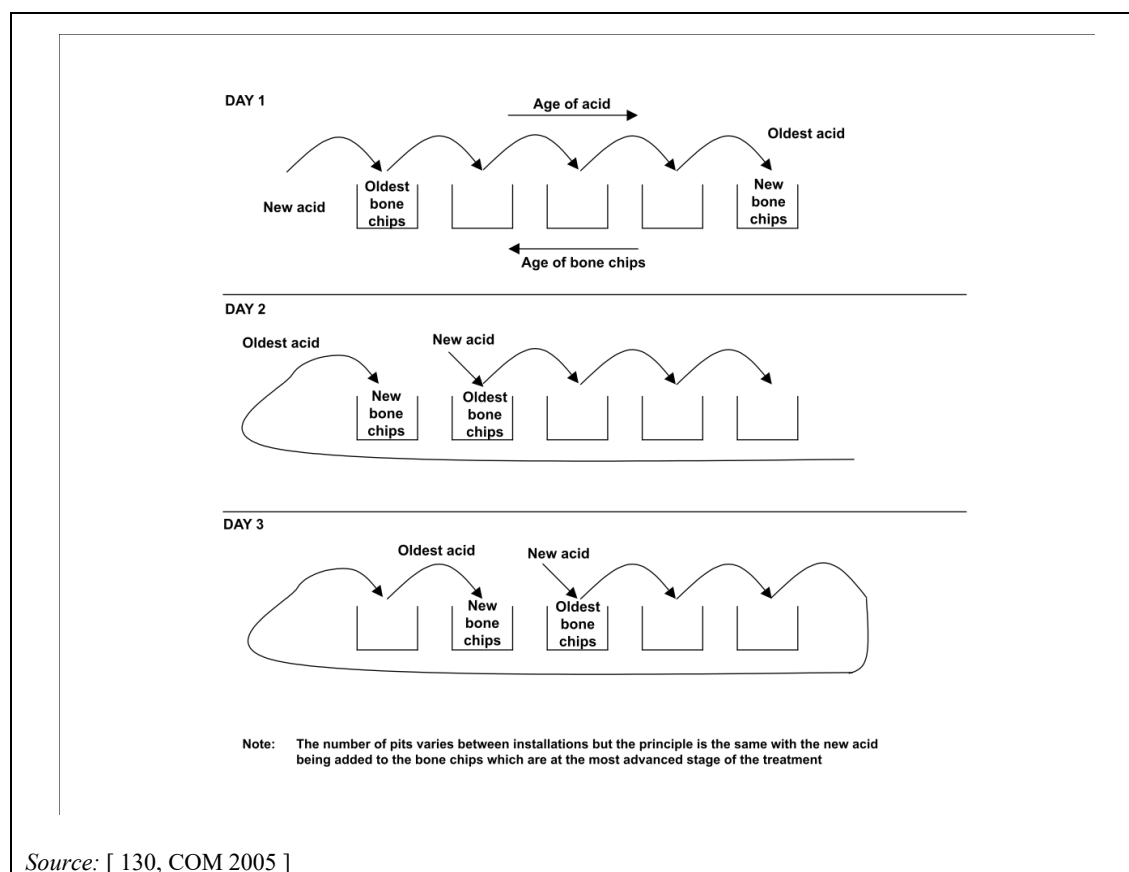

Figure 4.52: Flow diagram for the demineralisation of bone to produce ossein for gelatine manufacturing

C Liming

Liming is usually done in large concrete pits that can contain the ossein from one batch of demineralised bone chips. The ossein is submerged in a solution of supersaturated lime to purify and condition the collagen, to promote its hydrolysis. The pH during this process is approximately 12.5, i.e. the pH of freshly made lime solution. The supersaturated lime solution is refreshed regularly to compensate for its consumption during the process. Air is blown through regularly, to prevent local drops in the pH level.

After the last decanting of the lime, the ossein is washed by filling the lime pit with about the same amount of water as the weight of the original bone chips and leaving it in for some time before running it off. The ossein is then washed a second time by agitating it with approximately

the same amount of water, after which it is pumped in a stream of water to the neutralisation installation. The washings contain lime and can be used to neutralise the acid used in the early process, otherwise consumption of another alkali would be required for this.

A typical liming process schedule is shown in Table 4.23; the number of days varies between installations and can be as high as 90, depending on the quality of the bone chips, the average temperature of the lime and the desired physical properties of the gelatine. The frequency of refreshing the lime, the frequency and the time of blowing air into the pit and the number of times the ossein is washed, with or without agitation, also varies between installations and batches.

Table 4.23: Typical liming process schedule

Day	Adding fresh lime	Decanting	Pumping air	Washing
1	X			
2	X	X		
3			X	
4	X	X		
8			X	
9	X	X		
12			X	
15			X	
17	X	X		
21			X	
25			X	
27	X	X		
31			X	
35			X	
37	X	X		
41			X	
43			X	
46		X		X
<i>Source: [130, COM 2005]</i>				

D Neutralisation

The washed limed ossein still contains lime and has a high pH in the centre of the particles. It is treated with dilute acid to neutralise and remove the lime, and to change the pH to pH 4.5-7. The batch of ossein is submerged in at least as much water as the original weight of the bone chips from which the ossein was made. The ossein is stirred and the acid is added. The pH is measured continuously and can be used to control the flow of acid. When the pH remains constant for several hours within the desired pH range without acid being added, the ossein is considered to be neutralised. The acid water is then run off and the ossein is washed with at least five times its own weight of fresh water, whilst remaining submerged. The neutralisation can be done in one or more stirred tanks in the extraction vessel. The installation is usually made of stainless steel or plastic-coated steel.

E Extraction

The gelatine is extracted from the neutralised ossein, pretreated hides or pig skins, with hot water. This involves about 2 to 5 steps, at progressively higher temperatures, usually with no more than 10 °C difference between steps and typically ranging between 50-60 °C and 100 °C. The gelatine concentration of the extract is normally 3-8 %.

The water can be added cold and then heated, or already heated. The ossein in the extractors may be stirred carefully in the warm water or the water may be circulated over the ossein bed. This is continued until a concentration of about 5 % gelatine is reached. The extract is then drained and the process is repeated, usually at a higher temperature. When drained, the extract usually passes through a sieve or a mesh to prevent large particles getting into the pipework. The final extraction is stopped when, for example, while extracting at 100 °C, the concentration of gelatine does not

reach 3 % (temperature and concentration may vary depending on process and raw materials used), or when no ossein is left. The amount of water required is at least the amount needed to submerge the ossein or pig skins, plus the amount to fill the pipes, pumps and heat exchangers. For ossein coming from 50 tonnes of bone chips, the amount of gelatine in each extract is between 1 500 kg and 4 000 kg. The installations are normally made of stainless steel.

F Filtration

The extract is filtered to remove any insoluble particles. The filtration can be done in one or more steps. The filter medium is generally diatomaceous earth, cellulose or perlite, although cotton may also be used. If diatomaceous earth is used, a filter aid, usually composed of the same kind of diatomaceous earth as the filter, is added to the gelatine solution, to prevent blocking by continuously building up the filter layer. When using cellulose, pulp pads of about 5 cm thickness can be used. Often the filtration is done in two steps, the diatomaceous earth filter being followed by a filter that uses commercially available cellulose filter pads, which are about 1 cm thick. The extract may pass a cloth filter bag first, to remove residual coarse particles. During filtration the temperature of the solution is kept at 55-60 °C.

The filtration equipment is usually of the same type as that used in several branches of the food industry and is readily available. The diatomaceous earth filtration can be either pressure- or vacuum-operated. For pressure-operated filtration, the filter bed is in a closed vessel which is pressurised. When the maximum pressure is reached, the filter meshes are automatically cleaned and covered with a new filter aid. For vacuum filtration, the filter is usually a rotating drum filter with the filter layer on the outside of the drum. The extract is sucked into the inside of the drum. With this kind of filter, the filter aid and the layer are automatically scraped off, so the filter continuously has a fresh surface.

G Ion exchange

The filtered extract is passed through an ion exchange resin to remove all the dissolved salts from the solution. The solution normally first passes the cation column and then the anion column. Most installations consist of two cation columns and two anion columns. One of each is in use at any one time, while the other two are either regenerating or are on standby. Modern installations have an automatic control system that diverts the flow to the standby column as soon as the column in use reduces in effectiveness, at the same time starting the automatic regeneration procedure for the exhausted column. Older installations are less automated. The cation and anion exchangers are regenerated with approximately 5 % HCl and 5 % NaOH and both are rinsed using de-ionised water. During the ion exchange the temperature of the solution is generally kept at 55-60 °C. The installations are made of synthetic material or of plastic-coated steel.

H Concentration

After the solution comes from the ion exchangers the next step is to concentrate it. Different designs of evaporators can be used for concentrating gelatine solutions. Besides evaporation, membrane technologies were also proposed for the pre-concentration of the dilute gelatine extracts. Depending on the membrane used for ultrafiltration and the cost for electricity and steam, the removal could be done up to 10 % w/w. The pre-concentration by means of ultrafiltration leads to lower steam consumption at the evaporator. Additionally to a pre-concentration of the gelatine solution, a reduction of the salt content could be achieved [204, TWG 2021]. This facilitates the removal of water at relatively low temperatures. In multiple-effect vacuum evaporators, the vapour extracted from the first effect is used to heat the second and that from the second is used to heat the third. The heating and cooling are undertaken very quickly so that the product is not damaged. Figure 4.6 shows a schematic diagram of a multiple-effect evaporator. At this stage in the process the solution is about 20-30 % gelatine. The equipment is made of stainless steel.

I Sterilisation (or Heat treatment)

The concentrated gelatine solution is sterilised either by direct steam injection, such that the temperature is raised to 138-140 °C, or by indirect heating to achieve the final effect. The temperature may be lower depending on the processed raw material and applicable legal

requirements. The increase in temperature is achieved by injecting steam from another source. If direct steam injection is used, the solution is kept at this temperature for at least 4 seconds whilst maintaining a pressure of at least 4 bar (400 kPa). The temperature of the gelatine is measured and monitored continuously. The sterilising equipment is made of stainless steel.

J Drying

Belt drying

The sterilised concentrated gelatine solution is pumped through a heat exchanger and cooled to a temperature of less than 30 °C, to form a gel. The gel is extruded through a perforated sheet to form thin threads. A small pivoting conveyor belt or the cooler itself is used to deposit the noodles on to a large metal conveyor belt, which runs through a segmented drying tunnel. In the drying tunnel, the gel is dried with clean purified pre-dried warm air. Each subsequent segment of the tunnel has a higher temperature, ranging from 25-30 °C to 70 °C. The drying takes up to 6 hours. The heat for the dryer may be heat recovered from the hot water from the evaporator. When the gel enters the drying tunnel, it contains about 80 % water or less. The dried gelatine usually contains about 11 % water, although this may vary between 9 % and 15 %. After drying, the gelatine is crushed and packed for intermediate storage. The dried noodles are ground and bagged. Each batch is labelled for traceability. Various grades are blended to meet individual customer requirements. The equipment that comes into contact with the gelatine is usually made of stainless steel, but in some cases it is synthetic material [204, TWG 2021].

Drum/roller drying

The principle of drum drying is that a thin film of gelatine solution is applied to the smooth surface of a continuously rotating, steam-heated metal drum. This causes the spontaneous vaporisation of the water and the quick drying of gelatine. The fine dried gelatine film thus produced is then ground to a very fine powder.

The dried gelatine usually contains less than 8 % residual water. This method of drying provides the dried gelatine with better dissolution properties [204, TWG 2021].

Spray drying

In spray drying, the gelatine broth to be dried is suspended in air, i.e. the gelatine broth is converted into a fog-like mist or atomised liquid solution, providing a large surface area. The atomised gelatine solution is exposed to a flow of hot air in a drying chamber. The moisture evaporates quickly and the solids are recovered as a powder consisting of fine, hollow, spherical gelatine particles.

Heating the drying air can be accomplished by steam or by direct gas-fired air heaters or by indirect heaters fired by gas, liquid or solid fuels. Spray drying is applied mainly to hydrolysed gelatine broth [204, TWG 2021].

Leaf drying

The principle of leaf drying is that a thin film of gelatine solution is chilled whereby the gelatine layer turns from a liquid into a gel-phase film. After this, the gel-phase film is transferred from the cooling drum onto a drying belt and passes into the drying section. In the drying section the gel-phase film is dried, using hot and filtered air.

At the end of the drying section the dried film is removed from the drying belt and passes through a cutting device, which cuts the film into individual leaves (various sizes possible), after which they are packed [204, TWG 2021].

K Acid treatment

After the demineralisation process the tank containing the ossein is filled again, with the same amount of water as the original weight of the bone chips, and is left to stand in it for about 0.5-1 day. The ossein still contains sufficient acid to keep the pH below 2. The liquid is then removed and the ossein is washed again, one or more times, to obtain a pH of about 2.5 or above. It is then transferred to the extractors, in a stream of water.

L Alkali pretreatment

Following demineralisation, the ossein is soaked twice in water, each 'soak' lasts 1 hour and uses an equal volume of water to ossein. After each 'soak', the water is drained away. The ossein is further washed by stirring for 10 minutes with an equal volume of water to ossein and then drained.

One volume of 0.3 N NaOH (pH > 13) is added to the ossein and allowed to stand for 2 hours, with occasional agitation. The pH is monitored, recorded and maintained above pH 13 by the addition of NaOH solution, as required.

After the alkaline 'soak', the solution is drained and the ossein is washed twice. Each wash lasts for 15 minutes and uses an equal volume of water to ossein. Finally, the ossein is washed for 10 minutes with twice the volume of water to ossein.

M Acid treatment

A total of 1.2 times the volume of water compared to ossein is added to the alkali-pretreated ossein and by means of small additions of 1 N HCl, a pH of 2 is maintained for up to 6 hours, with occasional agitation.

The ossein is then washed a number of times, each wash using an equal volume of water to ossein, for at least 2 hours, until the pH is 2.5 or above.

N Preheating

An autoclave of about 6 800 litres is filled with 2 300 kg of degreased bone chips. It is preheated for 10 minutes by blowing steam at 1.7 bar (170 kPa) and 115 °C through it, from bottom to top.

O Autoclaving and extraction

The bone chips are pressurised and extracted in the following steps:

i - After preheating, the exhaust is closed and the autoclave is pressurised and heated from the bottom with steam at a minimum of 300 kPa and 133-135 °C for at least 23 minutes. The autoclave is depressurised in 4-5 minutes and then 1 500 litres of water is sprayed over the bone chips to extract the gelatine. The water is pumped out during the extraction. The pumping is continued for 12 minutes after the spraying is stopped.

ii - The autoclave is pressurised again for 20 minutes, with steam at 300 kPa and 133-135 °C, after which it is depressurised and the gelatine is extracted as described in step i.

iii - The autoclave is pressurised for 20 minutes with steam at 300 kPa and 133-135 °C, after which the autoclave is depressurised in 4-5 minutes. The autoclave is filled with 1 500 litres of water at 10 °C, which is left in the autoclave for 20 minutes and then forced out with steam under pressure. After the third autoclaving and extraction, the extract is not pumped out but forced out with steam.

iv - The bone chips are autoclaved and extracted as in step ii. Instead of water however, the bone chips are extracted with the extracts coming from the previous batch.

v and vi - The chips are autoclaved and extracted as in step ii. Parts of the extracts are saved for use as extraction liquid for this batch and the next batch.

P Cutting

The hide splits are cut and then washed with water.

Q Lime treatment

Slaked lime (Ca(OH)₂) is added until the relative density of the solution is 1.5-3° Bé. The treatment takes 6-11 weeks. During the liming process, the lime solution is controlled, by refreshing the lime and regularly blowing air through the solution, to maintain this relative density and a pH of approximately 12.5.

R Washing and acid treatment

When the lime treatment is finished, the raw material is washed in water in order to obtain a pH of 9-10. Acid is then added until a pH of 1.9-2 is obtained. During this time the pH is kept at 2.4 for 2-3 hours. Depending on the recipe, some alternative pH ranges or durations may be maintained, but the principle of washing and acid treatment is always the same.

S Neutralisation

The excess of acid is removed by washing with water until a slightly acid to neutral pH of, for example, 5.5-6.5 is obtained.

T Acid treatment

HCl, or another acid, is added until the pH of the solution is 1-3. These conditions are kept for 24-48 hours, by adding more acid, if necessary.

U Neutralisation

The excess acid is removed by washing with water to reach a typical pH of 5.3-6, but a pH of 2.5-4 is also possible.

V Alkali treatment

NaOH solution is added to the washed hide splits, to a concentration of 0.6-1.4 %. The alkaline soak takes a minimum of 10 days. During the process, the pH is approximately 12.5 or higher. Finally, air is regularly blown through the solution.

W Washing and acid treatment

When the caustic treatment is finished, the raw material is washed in water until a pH of about 10 is achieved. An acid solution is then added to neutralise the solution.

X Neutralisation

The excess acid is removed by washing with water, until a slightly acid, but close to neutral, pH of approximately 5.5-7.5 is obtained.

Y Cutting

The pig skins are cut into pieces of about 10 x 10 cm, in a special cutting machine.

Z Washing

The pig skin pieces are washed in a tank, to remove external fat.

A1 Acid treatment and rinsing

The pig skin pieces are acidulated, in a tank, with dilute H₂SO₄, HCl or H₃PO₄ to a pH below 2, for at least 5 hours. The acid solution is then removed and the pig skin pieces are then rinsed with water.

B1 Neutralisation and rinsing

The tank is filled with an alkaline solution of, for example, ammonia or another alkaline substance, to neutralise the pig skin pieces. The solution is then removed and the neutralised pig skins are rinsed, to reach a pH suitable for extraction of the gelatine. The pH may vary according to customer specification. The treated pig skins are then transferred to the extraction tanks.

C1 Second filtration

A second filtration is carried out to remove any remaining particles. The filter medium is usually a cloth bag which is able to remove coarse particles.

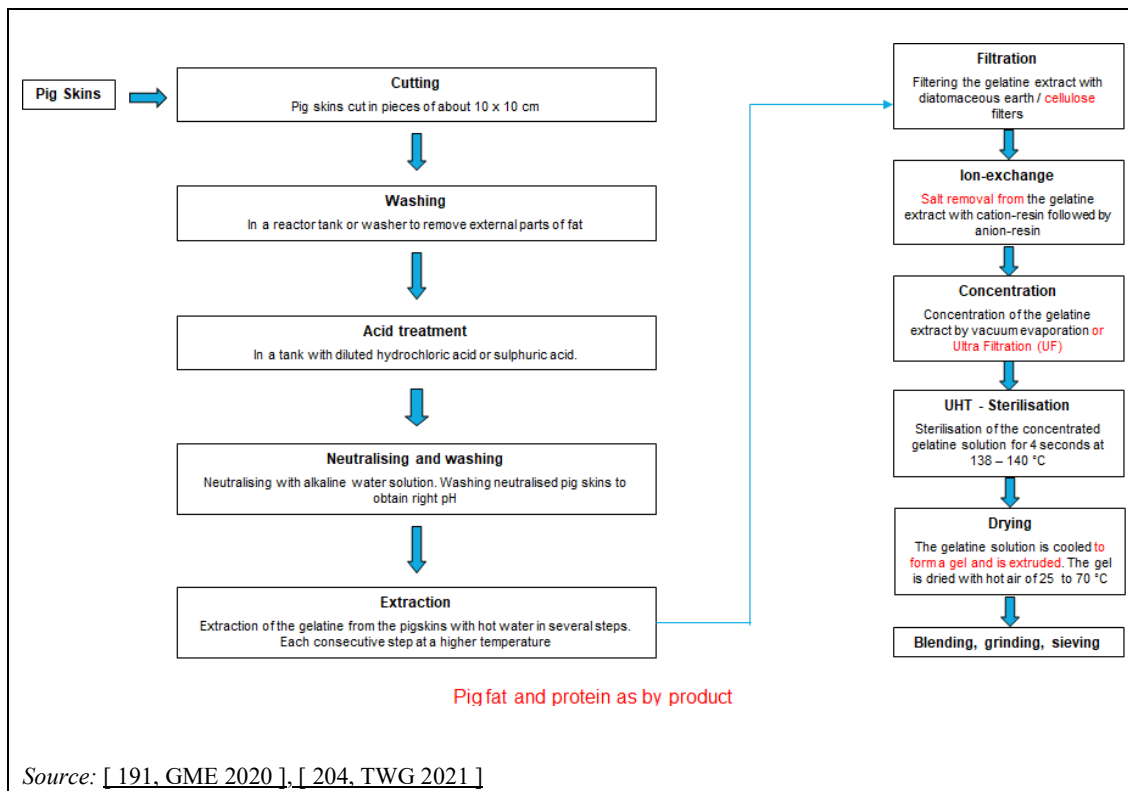

Figure 4.53: Production of gelatine from pig skins

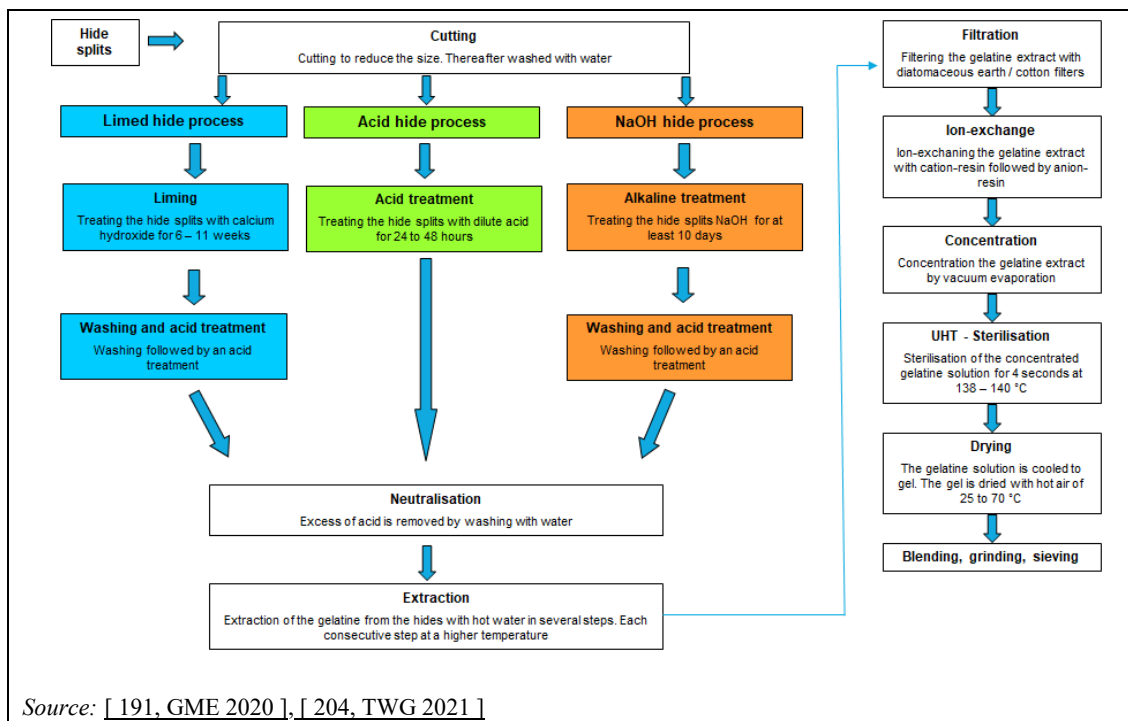

Figure 4.54: Production of gelatine from hides

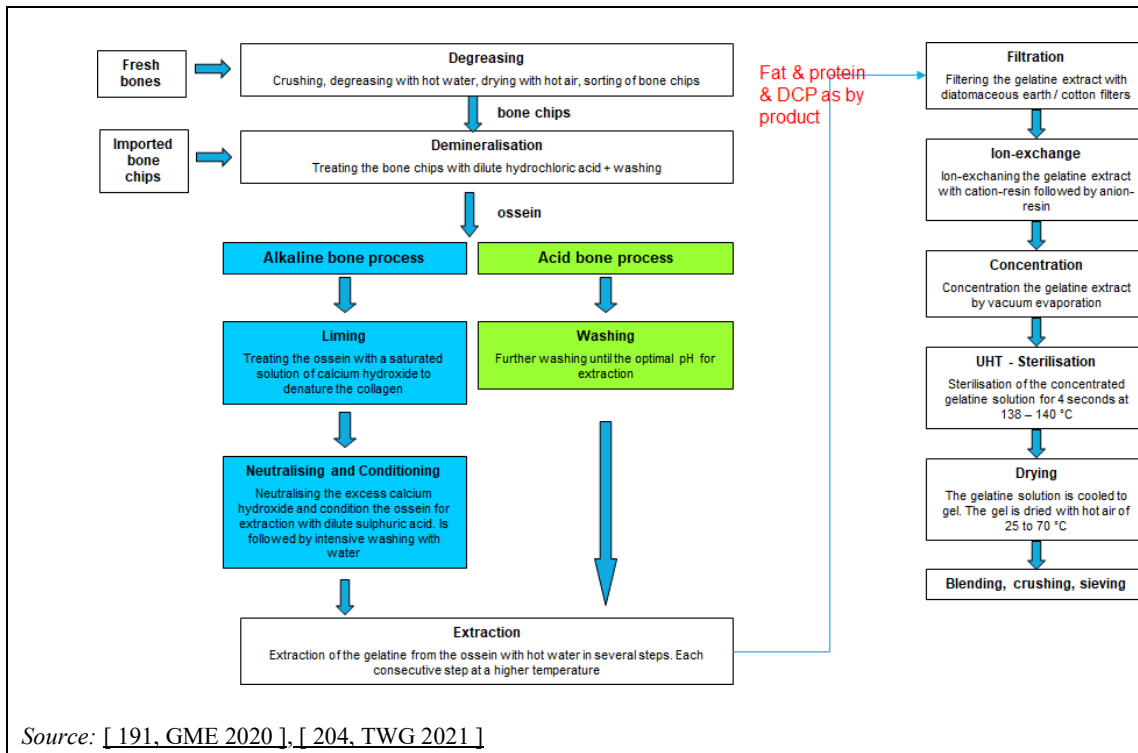

Figure 4.55: Production of gelatine from bones

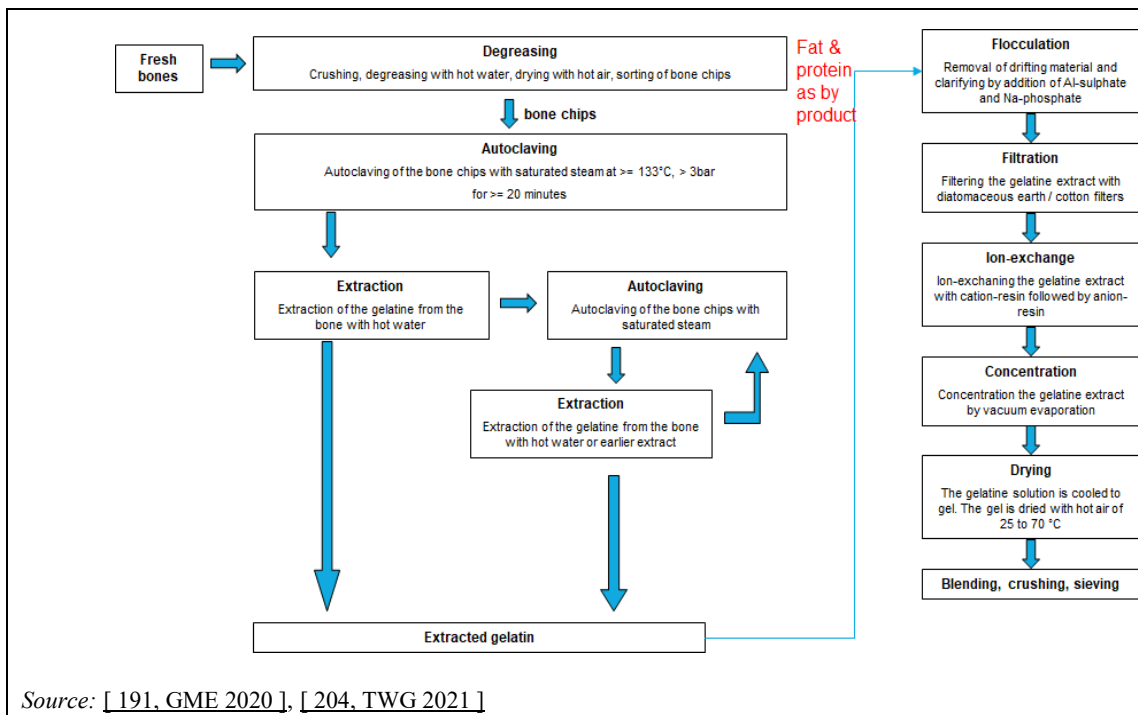

Figure 4.56: Production of gelatine from bones – heat and pressure processes

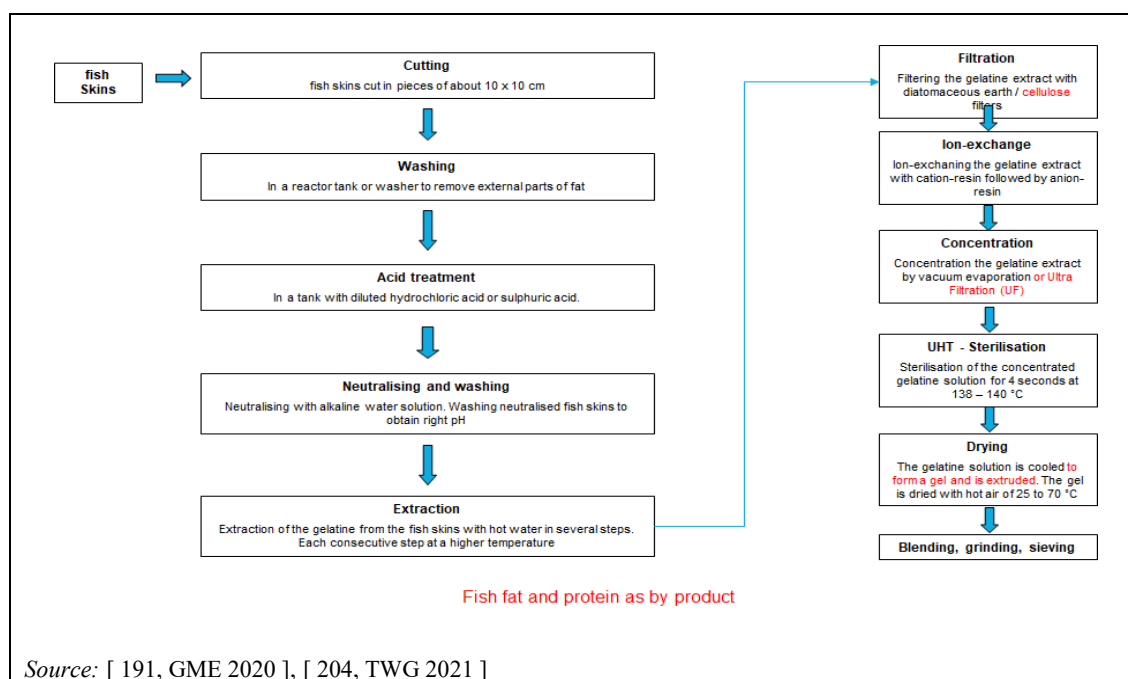

Figure 4.57: Production of gelatine from fish skins

4.5.2.2 Dicalcium phosphate manufacture from the gelatine manufacture demineralisation liquor

Dicalcium phosphate is used for feed and in fertilisers.

The liquor containing the spent acid and the water-soluble monocalcium phosphate is treated with lime ($\text{Ca}(\text{OH})_2$) to extract the dicalcium phosphate. After precipitation and decanting, the precipitate is centrifuged or filtered, washed with water and dried with hot air.

Precipitation and decanting

Lime ($\text{Ca}(\text{OH})_2$) slurry is added in a controlled manner and the pH is monitored. In an example installation, a tank of 75 m³ capacity is filled with 35 m³ of spent acid, containing monocalcium phosphate, at about pH 1.5 and 10 m³ of filtrate after the precipitation of dicalcium phosphate. The pH of the liquid is measured continuously. During powerful stirring, a solution of saturated lime is added quickly until pH 3.5 is reached. Then the addition of the lime is slowed down so that the pH rises to 5.5 in no less than 4 hours after the start of the addition. The suspension contains about 5 % solid matter. The chemical reaction is shown below:

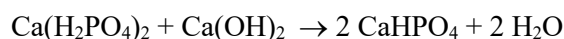

The suspension is pumped to a decanter while stirring is continued, to maintain a suspension. In the decanter, the suspension is separated and pumped to a tank, where the pH is adjusted. The suspension contains about 20 % solid matter at this stage.

The supernatant solution contains calcium chloride from the maceration process done with hydrochloric acid and dissolved or suspended organic compounds. It is treated in a WWTP.

Adjusting pH, filtration and washing

The tank containing the 20 % suspension is stirred to keep the solid matter suspended. The pH is measured continuously. A 4 % HCl solution is added to the suspension at a rate which ensures that the pH is maintained at about 5 for about 6.5 hours.

Stirring is continued, to keep the solid matter in suspension, while the mixture is pumped to a filtration installation. Either a centrifugal filter, a rotating vacuum filter or a vacuum conveyer belt filter is used. The filtrate is pumped back to the reactor tanks. The residue on the filter is washed with water and then sucked dry until the residue contains approximately 80 % dry matter. The dry matter is scraped off the filter and transported to a dryer.

Drying

The dicalcium phosphate is dried with air with a temperature of at least 70 °C in either a rotating dryer or a ring dryer, until it contains less than 3 % water. The air is then filtered.

The product is then packaged in bags or bulk tankers.

Associated activity - lime production

Production of the lime from quicklime (CaO) may in some cases be an associated site activity. Quicklime reacts vigorously with water to produce slaked lime.

4.5.3 Current emission and consumption levels

4.5.3.1 Energy consumption

The drying process is a significant energy consumer in the pretreatment of bones. A great deal of heat is emitted from the rendering vessel, which it is reported cannot be insulated due to expansion and contraction caused by the temperatures reached. Meal dryers use and emit heat and are insulated. There may be techniques available to recoup the high heat losses from this process.

Energy consumption is also high during drying of gelatine.

Bone de-fatting is an energy-intensive process which emits a lot of heat.

Figure 4.58 shows data (from installations participating in the data collection, for the years 2016 to 2018) in relation to total specific net energy consumption in kWh/tonne of raw material at installation level, as well as the applied techniques to reduce energy consumption.

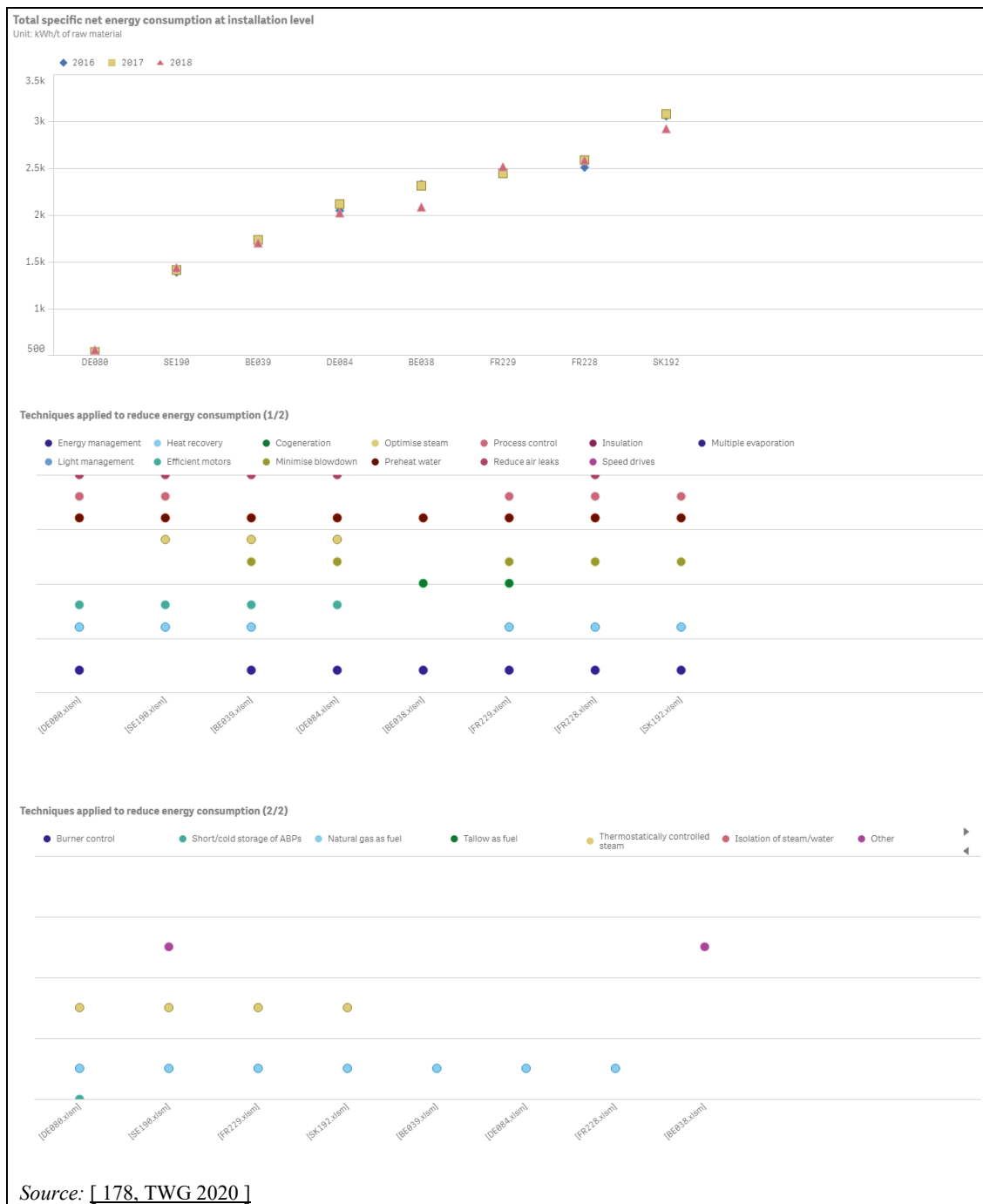

Figure 4.58: Specific net energy consumption (kWh/tonne of raw material) and applied techniques to reduce energy consumption in gelatine manufacturing (installation level)

Figure 4.59 shows data (from installations participating in the data collection, for the years 2016 to 2018) in relation to total specific net electricity and heat consumption in kWh/tonne of raw material at installation level.

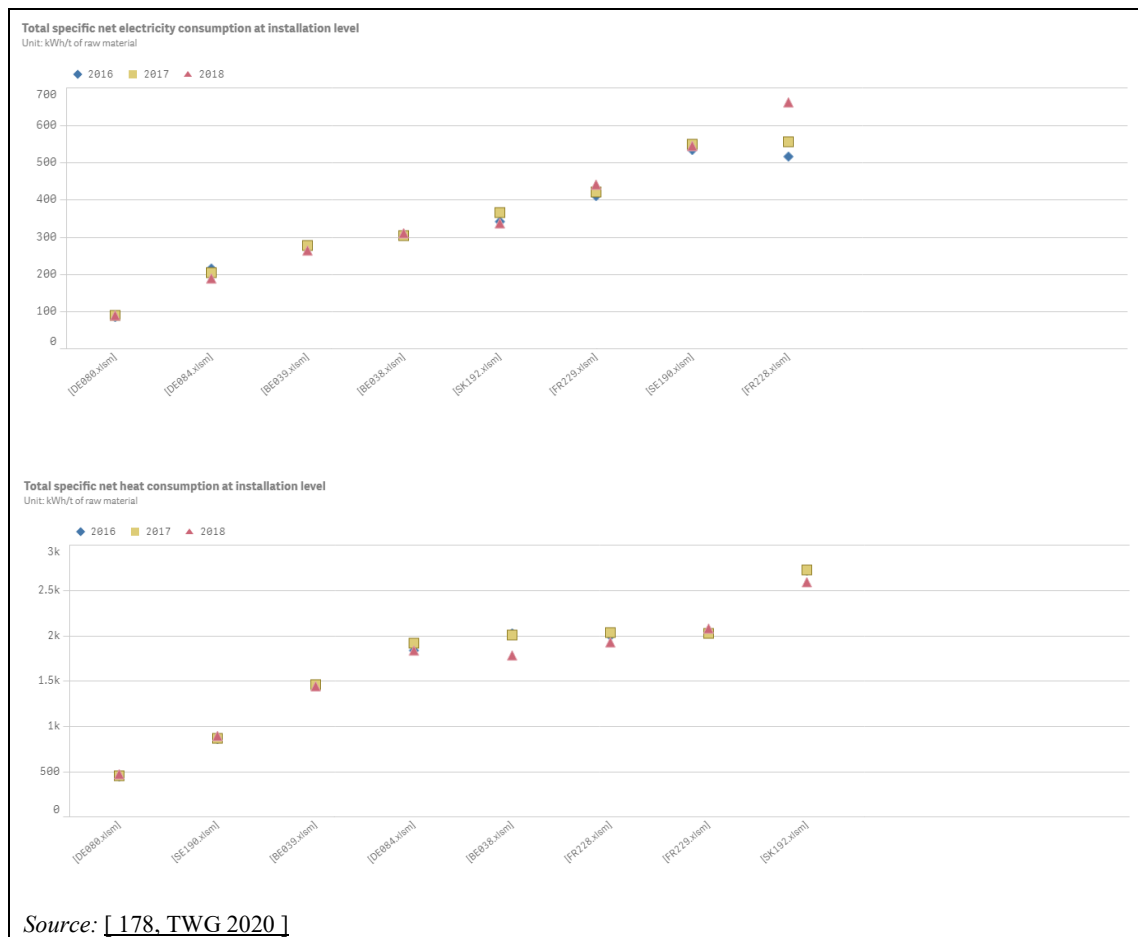

Figure 4.59: Specific electricity and heat consumption (kWh/tonne of raw material) in gelatine manufacturing (installation level)

Figure 4.60 shows the specific net energy consumption (from installations participating in the data collection, for the years 2016 to 2018) in kWh/tonne of raw material for the drying process in gelatine manufacturing.

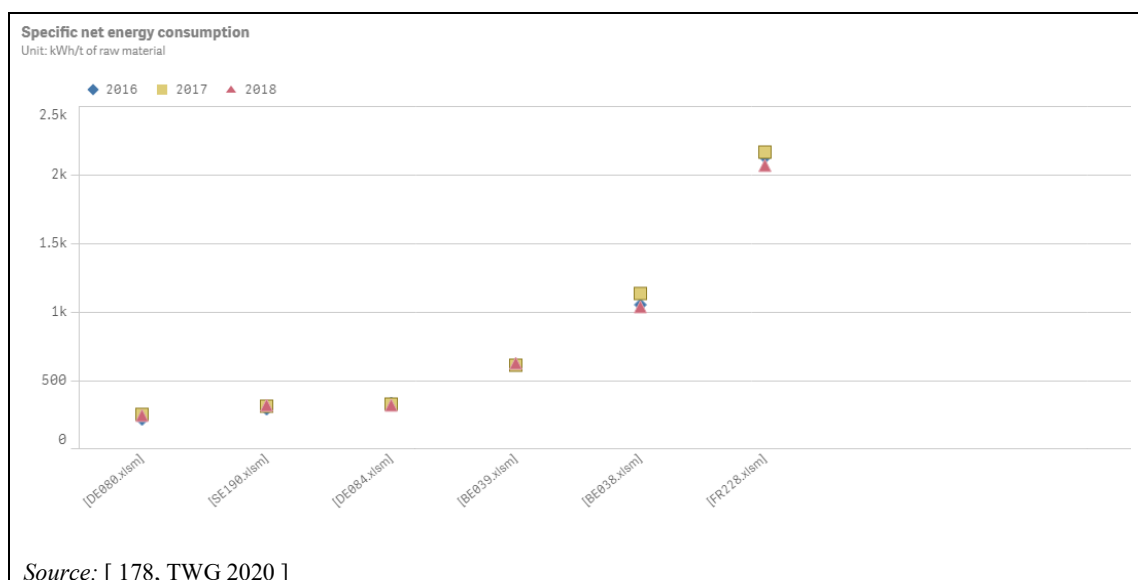

Figure 4.60: Specific net energy consumption (kWh/tonne of raw material) for the drying process in gelatine manufacturing

4.5.3.2 Water consumption

Figure 4.61 shows data (from installations participating in the data collection, for the years 2016 to 2018) in relation to total specific net water consumption in terms of m³/tonne of raw material at installation level.

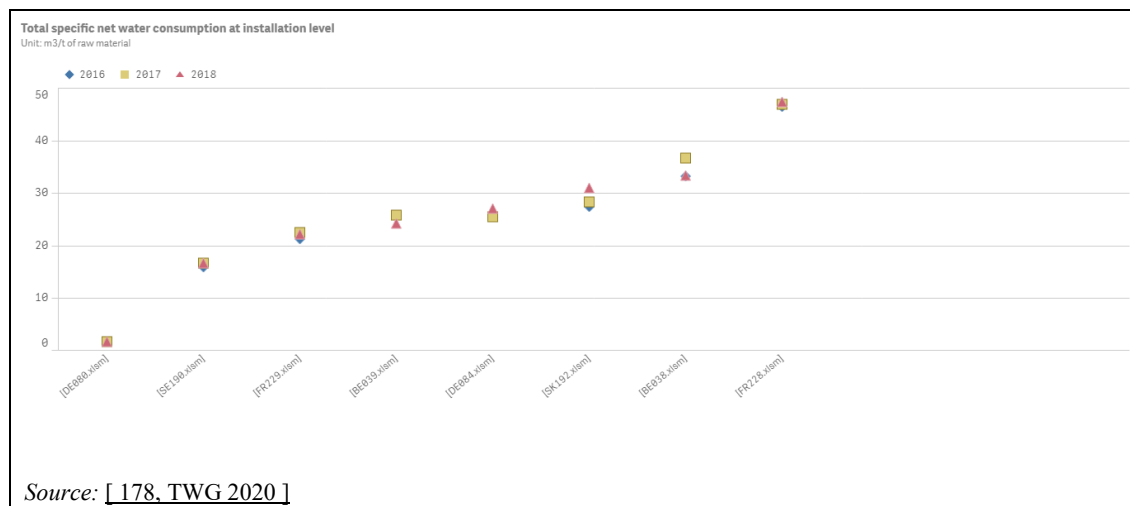

Figure 4.61: Specific net water consumption (m³/tonne of raw material) in gelatine manufacturing (installation level)

Figure 4.62 shows the specific net water consumption (from installations participating in the data collection, for the years 2016 to 2018) in m³/tonne of raw material for boilers in gelatine manufacturing.

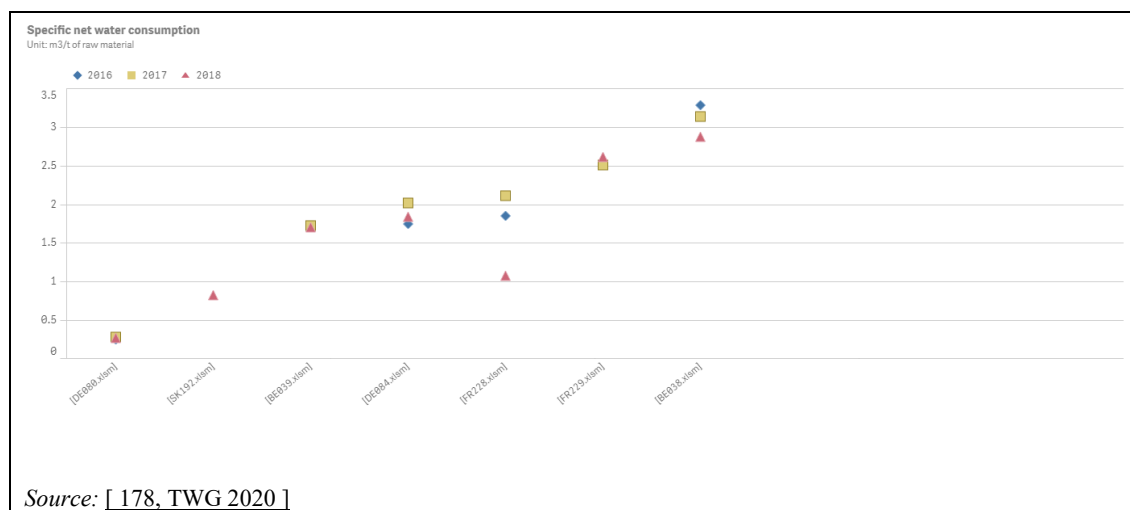

Figure 4.62: Specific net water consumption (m³/tonne of raw material) for boilers in gelatine manufacturing

4.5.3.3 Emissions to water

Figure 4.63 shows reported data (from installations participating in the data collection, for the years 2016 to 2018) on specific waste water discharges in m³/tonne of raw material from gelatine manufacturing and all types of discharges. The applied techniques for reducing water consumption are also shown.

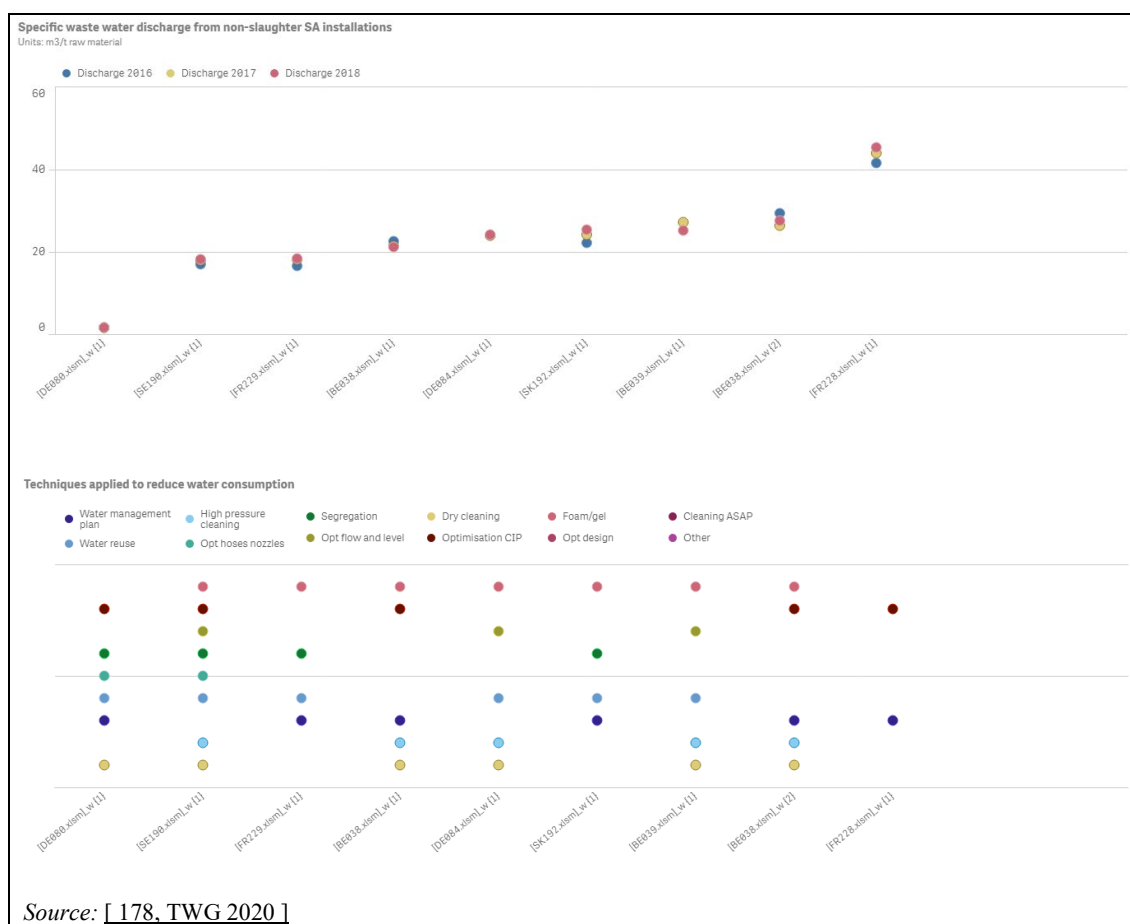

Figure 4.63: Specific waste water discharge (m³/tonne of raw material) and applied techniques for reducing water consumption in gelatine manufacturing for all types of discharges

The alkali and acid hydrolysis processes produce contaminated acid and alkali solutions respectively. Lime hydrolysis produces a soapy lime solution. Both processes are followed by thorough washing, which uses thousands of m³ of water which then have to be treated in the WWTP.

Untreated waste water from gelatine manufacturing has a high COD/BOD. The salt content of waste water is dependent on the raw materials and process used. Bone demineralisation waste water may contain higher chloride salt levels. If a plant has its own WWTP, then biological treatment, incorporating nitrification and denitrification steps, is required, due to the high protein levels. It can also be treated in municipal WWTPs. The chloride content of waste water is high due to its salt content.

4.5.3.4 Emissions to air

Data for odour emissions to air have been reported from only two points of release (one is outside the scope of the SA BREF). The maximum concentrations reported were 70 ou_E/m³ (using a biofilter) and 5 990 ou_E/m³ (no abatement technique used), respectively [178, TWG 2020].

4.5.4 Techniques to consider in the determination of BAT

4.5.4.1 Techniques to increase resource efficiency

4.5.4.1.1 Landspreading of sludge from gelatine and leather glue manufacture

Technical description

The sludge from waste water treatment from gelatine and leather glue manufacture is reported to be an excellent fertiliser and soil improver. It can be applied to agriculturally utilised soil, as a wet sludge or it can be thickened and pressed.

Achieved environmental benefits

Application of the by-products of gelatine production as fertiliser, when suitable agricultural land is available. The sludge contains calcium, nitrogen and phosphorus.

Cross-media effects

Iron, aluminium and manganese may be present and it may therefore be prudent to test for these.

Technical considerations relevant to applicability

Applicable when soil requirements match the nutrient level of the sludge.

Economics

Cheaper than paying for landfill.

Example plants

All gelatine and leather glue manufacturing WWTPs in Germany.

Reference literature

[62, Germany 2002], [107, United Kingdom 2003].

5 BEST AVAILABLE TECHNIQUES (BAT) CONCLUSIONS FOR SLAUGHTERHOUSES, ANIMAL BY-PRODUCTS AND/OR EDIBLE CO-PRODUCTS INDUSTRIES

SCOPE

These BAT conclusions concern the following activities specified in Annex I to Directive 2010/75/EU:

6.4. (a) Operating slaughterhouses with a carcass production capacity greater than 50 tonnes per day.

6.5. Disposal or recycling of animal carcasses or animal waste with a treatment capacity exceeding 10 tonnes per day.

6.11. Independently operated treatment of waste water not covered by Directive 91/271/EEC⁵, provided that the main pollutant load originates from the activities covered by these BAT conclusions.

These BAT conclusions also cover the following:

- the processing of animal by-products and/or edible co-products (such as rendering, fat melting, feather processing, fishmeal and fish oil production, blood processing and gelatine manufacturing) covered by the activity description in points 6.4 (b) (i) and/or 6.5 of Annex I to Directive 2010/75/EU;
- the combustion of meat-and-bone meal and/or animal fat;
- the combustion (e.g. in thermal oxidisers or steam boilers) of malodorous gases (originating from the activities covered by these BAT conclusions), including non-condensable gases;
- the incineration of carcasses if directly associated with the activities covered by these BAT conclusions;
- the preservation of hides and skins if directly associated with the activities covered by these BAT conclusions;
- the handling of casings and offal (viscera);
- composting and anaerobic digestion if directly associated with the activities covered by these BAT conclusions;
- the combined treatment of waste water from different origins, provided that the main pollutant load originates from the activities covered by these BAT conclusions and that the waste water treatment is not covered by Directive 91/271/EEC⁵.

These BAT conclusions do not cover the following:

- On-site combustion plants, not covered by the above bullet points, generating hot gases that are not used for direct contact heating, drying or any other treatment of objects or materials. These may be covered by the BAT conclusions for Large Combustion Plants (LCP) or by Directive (EU) 2015/2193 of the European Parliament and of the Council⁶.
- The production of food after the making of standard cuts for large animals or of cuts for poultry. This may be covered by the BAT conclusions for the Food, Drink and Milk Industries (FDM).

⁵ Council Directive 91/271/EEC of 21 May 1991 concerning urban waste-water treatment (OJ L 135, 30.5.1991, p. 40).

⁶ Directive (EU) 2015/2193 of the European Parliament and of the Council of 25 November 2015 on the limitation of emissions of certain pollutants into the air from medium combustion plants (OJ L 313, 28.11.2015, p. 1).

- Landfill of waste. This is covered by Council Directive 1999/31/EC⁷. In particular, underground permanent and long-term storage (≥ 1 year before disposal, ≥ 3 years before recovery) are covered by Directive 1999/31/EC.

Other BAT conclusions and reference documents which could be relevant for the activities covered by these BAT conclusions include the following:

- Large Combustion Plants (LCP);
- Food, Drink and Milk Industries (FDM);
- Common Waste Water and Waste Gas Treatment/Management Systems in the Chemical Sector (CWW);
- Waste Treatment (WT);
- Waste Incineration (WI);
- Tanning of Hides and Skins (TAN);
- Monitoring of Emissions to Air and Water from IED Installations (ROM);
- Economics and Cross-Media Effects (ECM);
- Emissions from Storage (EFS);
- Energy Efficiency (ENE);
- Industrial Cooling Systems (ICS).

These BAT conclusions apply without prejudice to other relevant legislation, e.g. on hygiene, food/feed safety, animal welfare, biosecurity, energy efficiency (energy efficiency first principle).

⁷ Council Directive 1999/31/EC of 26 April 1999 on the landfill of waste (OJ L 182, 16.7.1999, p. 1).

DEFINITIONS

For the purposes of these BAT conclusions, the following definitions apply:

General terms	
Term used	Definition
Animal by-products	As defined in Regulation (EC) No 1069/2009 of the European Parliament and of the Council of 21 October 2009 laying down health rules as regards animal by-products and derived products not intended for human consumption and repealing Regulation (EC) No 1774/2002 (Animal by-products Regulation) ⁽¹⁾ .
Channelled emissions	Emissions of pollutants to air through any kind of duct, pipe, stack, etc. This includes emissions from open-top biofilters.
Direct discharge	Discharge to a receiving water body without further downstream waste water treatment.
Edible co-products	Food-grade products intended for human consumption.
Existing plant	A plant that is not a new plant.
FDM activities	Activities covered by the BAT conclusions for the Food, Drink and Milk Industries.
FDM products	Products associated with activities covered by the BAT conclusions for the Food, Drink and Milk Industries.
Hazardous substance	Hazardous substance as defined in point 18 of Article 3 of Directive 2010/75/EU.
Indirect discharge	Discharge which is not a direct discharge.
New plant	A plant first permitted at the site of the installation following the publication of these BAT conclusions or a complete replacement of a plant following the publication of these BAT conclusions.
Sensitive receptor	Areas which need special protection, such as: <ul style="list-style-type: none"> residential areas; areas where human activities are carried out (e.g. neighbouring workplaces, schools, day-care centres, recreational areas, hospitals or nursing homes).
Substances of very high concern	Substances meeting the criteria mentioned in Article 57 and included in the Candidate List of Substances of Very High Concern, according to the REACH Regulation ((EC) No 1907/2006 ⁽²⁾).
<p>⁽¹⁾ OJ L 300, 14.11.2009, p. 1. ⁽²⁾ Regulation (EC) No 1907/2006 of the European Parliament and of the Council of 18 December 2006 concerning the Registration, Evaluation, Authorisation and Restriction of Chemicals (REACH), establishing a European Chemicals Agency, amending Directive 1999/45/EC and repealing Council Regulation (EEC) No 793/93 and Commission Regulation (EC) No 1488/94 as well as Council Directive 76/769/EEC and Commission Directives 91/155/EEC, 93/67/EEC, 93/105/EC and 2000/21/EC (OJ L 396, 30.12.2006, p. 1).</p>	

Pollutants and parameters	
Term used	Definition
AOX	Adsorbable organically bound halogens, expressed as Cl, include adsorbable organically bound chlorine, bromine and iodine.
As, Cd, Co, Cr, Cu, Mn, Ni, Pb, Sb, Tl, V	Arsenic, cadmium, cobalt, chromium, copper, manganese, nickel, lead, antimony, thallium and vanadium.
Biochemical oxygen demand (BOD _n)	Amount of oxygen needed for the biochemical oxidation of the organic matter to carbon dioxide in <i>n</i> days (<i>n</i> is typically 5 or 7). BOD is an indicator for the mass concentration of biodegradable organic compounds.
Chemical oxygen demand (COD)	Amount of oxygen needed for the total chemical oxidation of the organic matter to carbon dioxide using dichromate. COD is an indicator for the mass concentration of organic compounds.
CO	Carbon monoxide.

Pollutants and parameters	
Term used	Definition
Copper (Cu)	Copper, expressed as Cu, includes all inorganic and organic copper compounds, dissolved or bound to particles.
Dust	Total particulate matter (in air).
HCl	All inorganic gaseous chlorine compounds, expressed as HCl.
HF	All inorganic gaseous fluorine compounds, expressed as HF.
Hg	The sum of mercury and its compounds, expressed as Hg.
H ₂ S	Hydrogen sulphide.
Odour concentration	Number of European Odour Units (ou _E) in a cubic metre of gas at standard conditions for olfactometry according to EN 13725.
NO _x	The sum of nitrogen monoxide (NO) and nitrogen dioxide (NO ₂), expressed as NO ₂ .
PCDD/F	Polychlorinated dibenzo-p-dioxins and -furans.
SO _x	The sum of sulphur dioxide (SO ₂), sulphur trioxide (SO ₃), and sulphuric acid aerosols, expressed as SO ₂ .
Total nitrogen (Total N)	Total nitrogen, expressed as N, includes free ammonia and ammonium nitrogen (NH ₄ -N), nitrite nitrogen (NO ₂ -N), nitrate nitrogen (NO ₃ -N) and organically bound nitrogen.
Total organic carbon (TOC)	Total organic carbon (in water), expressed as C, includes all organic compounds.
Total phosphorus (Total P)	Total phosphorus, expressed as P, includes all inorganic and organic phosphorus compounds, dissolved or bound to particles.
Total suspended solids (TSS)	Mass concentration of all suspended solids (in water), measured via filtration through glass fibre filters and gravimetry.
Total volatile organic carbon (TVOC)	Total volatile organic carbon (in air), expressed as C.
Zinc (Zn)	Zinc, expressed as Zn, includes all inorganic and organic zinc compounds, dissolved or bound to particles.

ACRONYMS

For the purposes of these BAT conclusions, the following acronyms apply:

Acronym	Definition
CIP	Cleaning-in-place
CMS	Chemicals management system
EMS	Environmental management system
FDM	Food, drink and milk
IED	Industrial Emissions Directive (2010/75/EU)
OTNOC	Other than normal operating conditions
SA	Slaughterhouses, animal by-products and/or edible co-products industries

GENERAL CONSIDERATIONS

Best Available Techniques

The techniques listed and described in these BAT conclusions are neither prescriptive nor exhaustive. Other techniques may be used that ensure at least an equivalent level of environmental protection.

Unless otherwise stated, the BAT conclusions are generally applicable.

Emission levels associated with the best available techniques (BAT-AELs) for emissions to water

The BAT-AELs for emissions to water given in these BAT conclusions refer to concentrations (mass of emitted substances per volume of water), expressed in mg/l.

Averaging periods associated with the BAT-AELs refer to either of the following two cases:

- In the case of continuous discharge, daily average values, i.e. 24-hour flow-proportional composite samples.
- In the case of batch discharge, average values over the release duration taken as flow-proportional composite samples, or, provided that the effluent is appropriately mixed and homogeneous, a spot sample taken before discharge.

Time-proportional composite samples can be used provided that sufficient flow stability is demonstrated. Alternatively, spot samples may be taken, provided that the effluent is appropriately mixed and homogeneous.

In the case of total organic carbon (TOC), total nitrogen (TN) and chemical oxygen demand (COD), the calculation of the average abatement efficiency referred to in these BAT conclusions (see Table 5.1) is based on the influent and effluent load of the waste water treatment plant.

The BAT-AELs apply at the point where the emission leaves the installation.

Emission levels associated with the best available techniques (BAT-AELs) and indicative emission level for channelled emissions to air

The BAT-AELs and the indicative emission level for channelled emissions to air given in these BAT conclusions refer to concentrations (mass of emitted substances per volume of waste gas) under the following standard conditions: dry gas at a temperature of 273.15 K (or wet gas at a temperature of 293 K in the case of odour concentration) and a pressure of 101.3 kPa, without correction to a reference oxygen level, and expressed in the unit mg/Nm³ or ou_E/m³.

For averaging periods of BAT-AELs and the indicative emission level for channelled emissions to air, the following definition applies.

Type of measurement	Averaging period	Definition
Periodic	Average over the sampling period	Average value of three consecutive samplings/measurements of at least 30 minutes each ⁽¹⁾ .
⁽¹⁾ For any parameter where, due to sampling or analytical limitations, a 30-minute sampling/measurement is inappropriate, a more representative sampling/measurement procedure may be employed (e.g. for the odour concentration).		

When the waste gases of two or more sources (e.g. dryers) are discharged through a common stack, the BAT-AEL and the indicative emission level apply to the combined discharge from the stack.

Indicative emission levels for refrigerant losses

The indicative emission levels for refrigerant losses refer to a rolling average over 3 years of yearly losses. Yearly losses are expressed as a percentage (%) of the total amount of refrigerant contained in the cooling system(s). The losses for a specific refrigerant in 1 year are equal to the amount of that refrigerant used to refill the cooling system(s).

Other environmental performance levels associated with the best available techniques (BAT-AEPLs)

BAT-AEPLs for specific waste water discharge

The environmental performance levels related to specific waste water discharge refer to yearly averages and are calculated using the following equation:

$$\text{specific waste water discharge} = \frac{\text{waste water discharge}}{\text{activity rate}}$$

where:

waste water discharge: total amount of waste water discharged (direct discharge, indirect discharge and/or landspreading) by the specific processes concerned, expressed in m³/year, excluding any cooling water and run-off water that is discharged separately;

activity rate: total amount of products or raw materials processed, expressed in:

- tonnes of carcasses/year or animals/year for slaughterhouses;
- tonnes of raw materials/year for installations processing animal by-products and/or edible co-products.

The carcass weight depends on the animal species under consideration:

- Pigs: the weight of the slaughtered animal's cold body, either whole or divided in half along the midline, after being bled and eviscerated and after removal of the tongue, bristles, hooves, genitalia, flare fat, kidneys and diaphragm.
- Cattle: the weight of the slaughtered animal's cold body after being skinned, bled and eviscerated, and after removal of the external genitalia, limbs, head, tail, kidneys and kidney fats, and the udder.
- Chickens: the weight of the slaughtered animal's cold body after being bled, plucked and eviscerated. The weight includes offal (viscera).

BAT-AEPLs for specific net energy consumption

The environmental performance levels related to specific net energy consumption refer to yearly averages and are calculated using the following equation:

$$\text{specific net energy consumption} = \frac{\text{final net energy consumption}}{\text{activity rate}}$$

where:

final net energy consumption: total amount of energy consumed (excluding the recovered energy) by the installation (in the form of heat and electricity), expressed in kWh/year;

activity rate: total amount of products or raw materials processed, expressed in:

- tonnes of carcasses/year or animals/year for slaughterhouses;
- tonnes of raw materials/year for installations processing animal by-products and/or edible co-products.

The carcass weight depends on the animal species under consideration (see General consideration for BAT-AEPLs for specific waste water discharge).

Unless otherwise stated, the calculation of the energy consumption of slaughterhouses may include the energy consumed by FDM activities.

5.1 General BAT conclusions

5.1.1 Overall environmental performance

BAT 1. In order to improve the overall environmental performance, BAT is to elaborate and implement an environmental management system (EMS) that incorporates all of the following features:

- i. commitment, leadership, and accountability of the management, including senior management, for the implementation of an effective EMS;
- ii. an analysis that includes the determination of the organisation's context, the identification of the needs and expectations of interested parties, the identification of characteristics of the installation that are associated with possible risks for the environment and human health as well as of the applicable legal requirements relating to the environment;
- iii. development of an environmental policy that includes the continuous improvement of the environmental performance of the installation;
- iv. establishing objectives and performance indicators in relation to significant environmental aspects, including safeguarding compliance with applicable legal requirements;
- v. planning and implementing the necessary procedures and actions (including corrective and preventive actions where needed), to achieve the environmental objectives and avoid environmental risks;
- vi. determination of structures, roles and responsibilities in relation to environmental aspects and objectives and provision of the financial and human resources needed;
- vii. ensuring the necessary competence and awareness of staff whose work may affect the environmental performance of the installation (e.g. by providing information and training);
- viii. internal and external communication;
- ix. fostering employee involvement in good environmental management practices;
- x. establishing and maintaining a management manual and written procedures to control activities with significant environmental impact as well as relevant records;
- xi. effective operational planning and process control;
- xii. implementation of appropriate maintenance programmes;
- xiii. emergency preparedness and response protocols, including the prevention and/or mitigation of the adverse (environmental) impacts of emergency situations;
- xiv. when (re)designing a (new) installation or a part thereof, consideration of its environmental impacts throughout its life, which includes construction, maintenance, operation and decommissioning;
- xv. implementation of a monitoring and measurement programme; if necessary, information can be found in the Reference Report on Monitoring of Emissions to Air and Water from IED Installations;
- xvi. application of sectoral benchmarking on a regular basis;
- xvii. periodic independent (as far as practicable) internal auditing and periodic independent external auditing in order to assess the environmental performance and to determine whether or not the EMS conforms to planned arrangements and has been properly implemented and maintained;
- xviii. evaluation of causes of nonconformities, implementation of corrective actions in response to nonconformities, review of the effectiveness of corrective actions, and determination of whether similar nonconformities exist or could potentially occur;
- xix. periodic review, by senior management, of the EMS and its continuing suitability, adequacy and effectiveness;
- xx. following and taking into account the development of cleaner techniques.

Specifically for slaughterhouses as well as the processing of animal by-products and/or edible co-products, BAT is also to incorporate the following features in the EMS:

- xxi. an odour management plan (see BAT 18);
- xxii. an inventory of inputs and outputs (see BAT 2);
- xxiii. a chemicals management system (see BAT 3);
- xxiv. an energy efficiency plan (see BAT 9 (a));
- xxv. a water management plan (see BAT 10 (a));
- xxvi. a noise management plan (see BAT 16);
- xxvii. an OTNOC management plan (see BAT 4).
- xxviii. a refrigeration management plan for slaughterhouses (see BAT 21 (a) and BAT 23 (a)).

Note

Regulation (EC) No 1221/2009 establishes the European Union eco-management and audit scheme (EMAS), which is an example of an EMS consistent with this BAT.

Applicability

The level of detail and the degree of formalisation of the EMS will generally be related to the nature, scale and complexity of the installation, and the range of environmental impacts it may have.

BAT 2. In order to improve the overall environmental performance, BAT is to establish, maintain and regularly review (including when a significant change occurs) an inventory of inputs and outputs, as part of the environmental management system (see BAT 1) that incorporates all of the following features:

- I. Information about the production process(es), including:
 - a) simplified process flow sheets that show the origin of the emissions;
 - b) descriptions of process-integrated techniques and waste water/waste gas treatment techniques to prevent or reduce emissions, including their performance (e.g. abatement efficiency).
- II. Information about energy consumption and usage.
- III. Information about water consumption and usage (e.g. flow diagrams and water mass balances).
- IV. Information about the quantity and characteristics of the waste water streams, such as:
 - a) average values and variability of flow, pH and temperature;
 - b) average concentration and mass flow values of relevant substances/parameters (e.g. COD/TOC, nitrogen species, phosphorus) and their variability.
- V. Information about the characteristics of the waste gas streams, such as:
 - a) emission point(s);
 - b) average values and variability of flow and temperature;
 - c) average concentration and mass flow values of relevant substances/parameters (e.g. dust, TVOC, NO_x, SO_x) and their variability;
 - d) presence of other substances that may affect the waste gas treatment system or plant safety (e.g. oxygen, water vapour, dust).
- VI. Information about the quantity and characteristics of the chemicals used:
 - a) the identity and the characteristics of the chemicals used, including properties with adverse effects on the environment and/or human health;
 - b) the quantities of chemicals used and the location of their use.

Applicability

The level of detail and the degree of formalisation of the inventory will generally be related to the nature, scale and complexity of the installation, and the range of environmental impacts it may have.

BAT 3. In order to improve the overall environmental performance, BAT is to elaborate and implement a chemicals management system (CMS) as part of the EMS (see BAT 1) that incorporates all of the following features:

- I. A policy to reduce the consumption and risks associated with chemicals, including a procurement policy to select less harmful chemicals and their suppliers with the aim of minimising the use and risks associated with hazardous substances and substances of very high concern and avoiding the procurement of an excess amount of chemicals. The selection of chemicals is based on:
 - a) the comparative analysis of their bioeliminability/biodegradability, ecotoxicity and potential to be released into the environment, in order to reduce emissions to the environment;
 - b) the characterisation of the risks associated with the chemicals, based on the chemicals' hazard classification, pathways through the plant, potential release and level of exposure;
 - c) the regular (e.g. annual) analysis of the potential for substitution to identify potentially new available and safer alternatives to the use of hazardous substances and substances of very high concern (e.g. use of other chemicals with no or lower impacts on the environment and/or human health, see BAT 11 (a));
 - d) the anticipatory monitoring of regulatory changes related to hazardous substances and substances of very high concern and the safeguarding of compliance with applicable legal requirements.

The inventory of chemicals (see BAT 2) may be used to provide and keep the information needed for the selection of chemicals.

- II. Goals and action plans to avoid or reduce the use and risks associated with hazardous substances and substances of very high concern.
- III. Development and implementation of procedures for the procurement, handling, storage and use of chemicals to prevent or reduce emissions to the environment.

Applicability

The level of detail and the degree of formalisation of the CMS will generally be related to the nature, scale and complexity of the plant.

BAT 4. In order to reduce the frequency of the occurrence of OTNOC and to reduce emissions during OTNOC, BAT is to set up and implement a risk-based OTNOC management plan as part of the EMS (see BAT 1) that includes all of the following elements:

- i. identification of potential OTNOC (e.g. failure of equipment critical to the protection of the environment ('critical equipment')), of their root causes and of their potential consequences;
- ii. appropriate design of critical equipment (e.g. waste water treatment plant);
- iii. set-up and implementation of an inspection plan and preventive maintenance programme for critical equipment (see BAT 1 xii.);
- iv. monitoring (i.e. estimating or, where possible, measuring) and recording of emissions during OTNOC and of associated circumstances;
- v. periodic assessment of the emissions occurring during OTNOC (e.g. frequency of events, duration, amount of pollutants emitted) and implementation of corrective actions if necessary;

- vi. regular review and update of the list of identified OTNOC under point i. following the periodic assessment of point v.;
- vii. regular testing of backup systems.

Applicability

The level of detail and degree of formalisation of the OTNOC management plan will generally be related to the nature, scale and complexity of the plant, and the range of environmental impacts it may have.

5.1.2 Monitoring

BAT 5. For waste water streams identified by the inventory of inputs and outputs (see BAT 2), BAT is to monitor key process parameters (e.g. continuous monitoring of waste water flow, pH and temperature) at key locations (e.g. at the inlet and/or outlet of the waste water pretreatment, at the inlet to the final waste water treatment, at the point where the emission leaves the installation).

BAT 6. BAT is to monitor at least once per year:

- the yearly consumption of water and energy;
- the yearly amount of waste water generated;
- the yearly amount of refrigerant(s) used to refill the cooling system(s) in slaughterhouses.

Description

Monitoring preferentially includes direct measurements. Calculations or recording, e.g. using suitable meters or invoices, can also be used. The monitoring is performed at installation level (and can be broken down to the most appropriate process level) and considers any significant changes in the processes.

BAT 7. BAT is to monitor emissions to water with at least the frequency given below and in accordance with EN standards. If EN standards are not available, BAT is to use ISO, national or other international standards that ensure the provision of data of an equivalent scientific quality.

Substance/Parameter		Activities	Standard(s)	Minimum monitoring frequency ⁽¹⁾	Monitoring associated with
Adsorbable organically bound halogens (AOX) ⁽²⁾ ⁽³⁾		All activities	EN ISO 9562	Once every 3 months ⁽⁴⁾	BAT 14
Biochemical oxygen demand (BOD _n) ⁽⁵⁾			Various EN standards available (e.g. EN 1899-1, EN ISO 5815-1)	Once every month	
Chemical oxygen demand (COD) ⁽⁵⁾ ⁽⁶⁾			No EN standard available	Once every week ⁽⁷⁾	
Total nitrogen (TN) ⁽⁵⁾			Various EN standards available (e.g. EN 12260, EN ISO 11905-1)		
Total organic carbon (TOC) ⁽⁵⁾ ⁽⁶⁾			EN 1484		
Total phosphorus (TP) ⁽⁵⁾			Various EN standards available (e.g. EN ISO 6878, EN ISO 15681-1 and -2, EN ISO 11885)		
Total suspended solids (TSS) ⁽⁵⁾			EN 872		
Metals	Copper (Cu) ⁽²⁾ ⁽³⁾	Slaughterhouses	Various EN standards available (e.g. EN ISO 11885, EN ISO 17294-2 or EN ISO 15586)	Once every 6 months	
	Zinc (Zn) ⁽²⁾ ⁽³⁾				
Chloride (Cl ⁻) ⁽²⁾ ⁽³⁾		<ul style="list-style-type: none"> Slaughterhouses Hide/skin salting Gelatine manufacturing using bones as raw material 	Various EN standards available (e.g. EN ISO 10304-1, EN ISO 15682)	Once every month ⁽⁴⁾	-
<p>(1) In the case of batch discharge less frequent than the minimum monitoring frequency, monitoring is carried out once per batch.</p> <p>(2) In the case of an indirect discharge, the monitoring frequency may be reduced to once every year for Cu and Zn and once every 6 months for AOX and Cl⁻ if the downstream waste water treatment plant is designed and equipped appropriately to abate the pollutants concerned.</p> <p>(3) The monitoring only applies when the substance/parameter concerned is identified as relevant in the waste water stream based on the inventory of inputs and outputs mentioned in BAT 2.</p> <p>(4) The minimum monitoring frequency may be reduced to once every 6 months if the emission levels are proven to be sufficiently stable.</p> <p>(5) The monitoring only applies in the case of a direct discharge.</p> <p>(6) Either COD or TOC is monitored. TOC monitoring is the preferred option because it does not rely on the use of very toxic compounds.</p> <p>(7) The minimum monitoring frequency may be reduced to once every month if the emission levels are proven to be sufficiently stable.</p>					

BAT 8. BAT is to monitor channelled emissions to air with at least the frequency given below and in accordance with EN standards. If EN standards are not available, BAT is to use ISO, national or other international standards that ensure the provision of data of an equivalent scientific quality.

Substance/ Parameter	Activities/Processes	Standard(s)	Minimum monitoring frequency (¹)	Monitoring associated with
CO	Combustion (e.g. in thermal oxidisers or steam boilers) of malodorous gases, including non-condensable gases	EN 15058	Once every year	BAT 15
	Incineration of carcasses			-
Dust	Combustion (e.g. in thermal oxidisers or steam boilers) of malodorous gases, including non-condensable gases	EN 13284-1		BAT 15
	Incineration of carcasses			-
NO _x	Combustion (e.g. in thermal oxidisers or steam boilers) of malodorous gases, including non-condensable gases	EN 14792		BAT 15
	Incineration of carcasses			-
SO _x	Combustion (e.g. in thermal oxidisers or steam boilers) of malodorous gases, including non-condensable gases	EN 14791		BAT 15
	Incineration of carcasses			-
H ₂ S	Rendering, fat melting, blood and/or feather processing (²)	No EN standard available		
NH ₃	Rendering, fat melting, blood and/or feather processing	EN ISO 21877		BAT 25
	Combustion (e.g. in thermal oxidisers or steam boilers) of malodorous gases, including non-condensable gases			
	Incineration of carcasses			-
TVOC	Rendering, fat melting, blood and/or feather processing	EN 12619		BAT 25
	Combustion (e.g. in thermal oxidisers or steam boilers) of malodorous gases, including non-condensable gases			
	Incineration of carcasses			-
Odour concentration	Slaughterhouses (³) (⁴)	EN 13725		-
	Incineration of carcasses (³)		-	
	Gelatine manufacturing (³)		-	
	Fishmeal and fish oil production (³)		-	
	Rendering, fat melting, blood and/or feather processing (³)		BAT 25	
HCl	Incineration of carcasses	EN 1911		
HF		No EN standard available	-	
Hg		EN 13211		

Substance/ Parameter	Activities/Processes	Standard(s)	Minimum monitoring frequency (¹)	Monitoring associated with
Metals and metalloids except mercury (As, Cd, Co, Cr, Cu, Mn, Ni, Pb, Sb, Tl, V)	Incineration of carcasses	EN 14385	Once every year	
PCDD/F		EN 1948-1, EN 1948-2, EN 1948-3		
<p>(¹) To the extent possible, the measurements are carried out at the highest expected emission state under normal operating conditions.</p> <p>(²) The monitoring only applies when H₂S is identified as relevant in the waste gas stream based on the inventory of inputs and outputs mentioned in BAT 2.</p> <p>(³) This includes combustion (e.g. in thermal oxidisers or steam boilers) of malodorous gases, including non-condensable gases.</p> <p>(⁴) The monitoring only applies when odour is identified as relevant in the waste gas stream based on the inventory of inputs and outputs mentioned in BAT 2.</p>				

5.1.3 Energy efficiency

BAT 9. In order to increase energy efficiency, BAT is to use both of the techniques given below.

Technique	Description	Applicability
a Energy efficiency plan and audits	An energy efficiency plan is part of the environmental management system (see BAT 1) and entails defining and calculating the specific energy consumption of the activity (or activities), setting key performance indicators on an annual basis (for example for the specific energy consumption) and planning periodic improvement targets and related actions. Audits are carried out at least once every year to ensure that the objectives of the energy efficiency plan are met and the energy audits' recommendations are followed-up and implemented.	The level of detail of the energy efficiency plan and audits will generally be related to the nature, scale and complexity of the plant.
b General energy-saving techniques	These include techniques such as: <ul style="list-style-type: none"> - heat recovery with heat exchangers and/or heat pumps; - energy-efficient motors; - frequency converters on motors; - process control systems; - combined heat and power generation (cogeneration); - insulation of pipes, vessels and other equipment; - combustion regulation and control; - feed water preheating (including the use of economisers); - minimisation of the blowdown of boilers; - optimisation of steam distribution systems; - reduction of compressed air system leaks; - lighting management systems; - energy-efficient lighting; - optimisation of design and operation of cooling system(s). 	Applicability of cogeneration to existing plants may be restricted by a suitable heat demand and/or by the plant layout/lack of space.

Further sector-specific techniques to increase energy efficiency are given in Section 5.2.1 and Section 5.3.1 of these BAT conclusions.

5.1.4 Water consumption and waste water generation

BAT 10. In order to reduce water consumption and the amount of waste water generated, BAT is to use both techniques (a) and (b), and an appropriate combination of the techniques (c) to (k) given below.

Technique	Description	Applicability
<i>Management, design and operation techniques</i>		
a	Water management plan and water audits A water management plan and water audits are part of the environmental management system (see BAT 1) and include: <ul style="list-style-type: none"> • flow diagrams and water mass balances of the plant and processes as part of the inventory of inputs and outputs mentioned BAT 2; • establishment of water efficiency objectives; • implementation of water optimisation techniques (e.g. control of water usage, reuse/recycling, detection and repair of leaks). Water audits are carried out at least once every year to ensure that the objectives of the water management plan are met and the water audits' recommendations are followed-up and implemented.	The level of detail and nature of the water management plan and water audits will generally be related to the nature, scale and complexity of the plant.
b	Segregation of water streams Water streams that do not need treatment (e.g. uncontaminated cooling water, uncontaminated run-off water) are segregated from waste water that has to undergo treatment, thus enabling uncontaminated water recycling.	Applicability to existing plants may be restricted by the layout of the water collection system and the lack of space for temporary storage tanks.
c	Water reuse and/or recycling Recycling and/or reuse of water streams (preceded or not by water treatment), e.g. for cleaning, washing, cooling or for the process itself.	May not be applicable due to hygiene and safety requirements.
d	Optimisation of water flow Use of control devices, e.g. photocells, flow valves, thermostatic valves, to automatically adjust the water flow to the minimum amount needed.	Generally applicable.
e	Optimisation and appropriate use of water nozzles and hoses Use of correct number and position of nozzles; adjustment of water pressure of nozzles and hoses.	
<i>Techniques related to cleaning operations</i>		
f	Dry cleaning Removal of as much residual material as possible from raw materials and equipment, e.g. by using compressed air, vacuum systems or catchpots with a mesh cover.	Generally applicable.
g	High-pressure cleaning Spraying of cleaning water at pressures ranging from 15 bar to 150 bar.	May not be applicable due to health and safety requirements.
h	Optimisation of chemical dosing and water use in cleaning-in-place (CIP) The amounts of hot water and chemicals used are optimised by measuring for example turbidity, conductivity, temperature and/or pH.	Generally applicable.
i	Low-pressure foam and/or gel cleaning Use of low-pressure foam and/or gel to clean walls, floors and/or equipment surfaces.	

Technique		Description	Applicability
j	Optimised design and construction of equipment and process areas	The equipment and process areas are designed and constructed in a way that facilitates cleaning. When optimising the design and construction, hygiene requirements are taken into account.	Generally applicable
k	Prompt cleaning of equipment	Cleaning is applied as soon as possible after use of equipment to prevent hardening of residual material.	

Further sector-specific techniques to reduce water consumption and the volume of waste water generated are given in Section 5.2.2 and Section 5.3.2 of these BAT conclusions.

5.1.5 Harmful substances

BAT 11. In order to prevent or, where that is not practicable, to reduce the use of harmful substances in cleaning and disinfection, BAT is to use one or a combination of the techniques given below.

Technique		Description
a	Proper selection of cleaning chemicals and/or disinfectants	Avoidance or minimisation of the use of cleaning chemicals and/or disinfectants that are harmful to the aquatic environment, in particular those that contain priority substances considered under the Water Framework Directive ⁸ . When selecting the cleaning chemicals and/or disinfectants, hygiene and food safety requirements are taken into account. This technique is part of the CMS (see BAT 3).
b	Reuse of cleaning chemicals in cleaning-in-place (CIP)	Collection and reuse of cleaning chemicals in CIP. When reusing cleaning chemicals, hygiene and food safety requirements are taken into account.
c	Dry cleaning	See BAT 10 (f).
d	Optimised design and construction of equipment and process areas	See BAT 10 (j).

5.1.6 Resource efficiency

BAT 12. In order to increase resource efficiency, BAT is to use both techniques (a) and (b), if appropriate in combination with one or both of the techniques (c) and (d) given below.

Technique		Description	Applicability
a	Minimisation of biological degradation of animal by-products and/or edible co-products	Animal by-products and/or edible co-products are promptly collected in slaughterhouses and are stored in closed vessels or rooms in SA installations, for as short a time as possible, before further treatment. Raw materials intended for human consumption (e.g. fat, blood), feed material or pet food may require refrigeration.	Generally applicable.
b	Residues separation and recycling/recovery	Residues are separated, e.g. using accurately positioned screens, flaps, catchpots, drip trays and troughs, for recycling and recovery.	

⁸ Directive 2000/60/EC of the European Parliament and of the Council of 23 October 2000 establishing a framework for Community action in the field of water policy (OJ L327, 22.12.2000, p. 1).

Technique		Description	Applicability
c	Anaerobic digestion	Treatment of biodegradable residues by microorganisms in the absence of oxygen, resulting in the generation of biogas and digestate. The biogas is used as a fuel, e.g. in a gas engine or in a boiler. The digestate may be used, e.g. as a soil improver, on site or off site.	May not be applicable due to the quantity and/or nature of the residues.
d	Phosphorus recovery as struvite	See Section 5.4.1.	Only applicable to waste water streams with a high total phosphorus content (e.g. above 50 mg/l) and a significant flow.

5.1.7 Emissions to water

BAT 13. In order to prevent uncontrolled emissions to water, BAT is to provide an appropriate buffer storage capacity for generated waste water.

Description

The appropriate buffer storage capacity is determined by a risk assessment (taking into account the nature of the pollutant(s), the effects of these pollutants on further waste water treatment, the receiving environment, the amount of waste water generated, etc.).

A buffer tank is typically designed to store the amounts of waste water generated during several peak hours of operation.

The waste water from this buffer storage is discharged after appropriate measures are taken (e.g. monitoring, treatment, reuse).

Applicability

For existing plants, the technique may not be applicable due to lack of space and/or due to the layout of the waste water collection system.

BAT 14. In order to reduce emissions to water, BAT is to use an appropriate combination of the techniques given below.

	Technique ⁽¹⁾	Typical pollutants targeted	Applicability
<i>Preliminary, primary and general treatment</i>			
a	Equalisation	All pollutants	Generally applicable.
b	Neutralisation	Acids, alkalis	
c	Physical separation, e.g. screens, sieves, grit separators, fat separators, primary settlement tanks	Gross solids, suspended solids, oil/grease	
<i>Physico-chemical treatment</i>			
d	Precipitation	Precipitable dissolved non-biodegradable or inhibitory pollutants, e.g. metals	Generally applicable.
e	Chemical oxidation (e.g. with ozone)	Reducible dissolved non-biodegradable or inhibitory pollutants, e.g. AOX, antimicrobial-resistant bacteria	
<i>Aerobic and/or anaerobic treatment (secondary treatment)</i>			
f	Aerobic and/or anaerobic treatment (secondary treatment), e.g. activated sludge process, aerobic lagoon, anaerobic contact process, membrane bioreactor	Biodegradable organic compounds	Generally applicable.
<i>Nitrogen removal</i>			
g	Nitrification and/or denitrification	Total nitrogen, ammonium/ammonia	Nitrification may not be applicable in the case of high chloride concentrations (e.g. above 10 g/l). Nitrification may not be applicable when the temperature of the waste water is low (e.g. below 12 °C).
<i>Phosphorus removal</i>			
h	Precipitation	Total phosphorus	Generally applicable.
i	Enhanced biological phosphorus removal		
j	Phosphorus recovery as struvite		Only applicable to waste water streams with a high total phosphorus content (e.g. above 50 mg/l) and a significant flow.
<i>Final solids removal</i>			
k	Coagulation and flocculation	Suspended solids and particulate-bound non-biodegradable or inhibitory pollutants	Generally applicable.
l	Sedimentation		
m	Filtration (e.g. sand filtration, microfiltration, ultrafiltration, reverse osmosis)		
n	Flotation		
⁽¹⁾ The descriptions of the techniques are given in Section 5.4.1.			

Table 5.1: BAT-associated emission levels (BAT-AELs) for direct discharges

Substance/Parameter		Unit	BAT-AEL ⁽¹⁾ ⁽²⁾
Chemical oxygen demand (COD) ⁽³⁾		mg/l	25–100 ⁽⁴⁾ ⁽⁵⁾
Total organic carbon (TOC) ⁽³⁾			7–35 ⁽⁵⁾ ⁽⁶⁾
Total suspended solids (TSS)			4–30 ⁽⁵⁾ ⁽⁷⁾ ⁽⁸⁾
Total nitrogen (Total N)			2–25 ⁽⁵⁾ ⁽⁹⁾ ⁽¹⁰⁾
Total phosphorus (Total P)			0.25–2 ⁽⁵⁾
Adsorbable organically bound halogens (AOX) ⁽¹¹⁾			0.02–0.3
Metals	Copper (Cu) ⁽¹¹⁾		0.01–0.2 ⁽¹²⁾
	Zinc (Zn) ⁽¹¹⁾	0.05–0.5 ⁽¹²⁾	

⁽¹⁾ The averaging periods are defined in the general considerations.
⁽²⁾ No BAT-AEL applies for biochemical oxygen demand (BOD). As an indication, the yearly average BOD₅ level in the effluent from a biological waste water treatment plant will generally be ≤ 20 mg/l.
⁽³⁾ Either the BAT-AEL for COD or the BAT-AEL for TOC applies. The BAT-AEL for TOC is the preferred option because TOC monitoring does not rely on the use of very toxic compounds.
⁽⁴⁾ The upper end of the BAT-AEL range may be higher and up to 120 mg/l for installations processing animal by-products and/or edible co-products, only if the COD abatement efficiency is ≥ 95 % as a yearly average or as an average over the production period.
⁽⁵⁾ The BAT-AEL range may not apply for discharges of seawater from fishmeal and fish oil production.
⁽⁶⁾ The upper end of the BAT-AEL range may be higher and up to 40 mg/l for installations processing animal by-products and/or edible co-products, only if the TOC abatement efficiency is ≥ 95 % as a yearly average or as an average over the production period.
⁽⁷⁾ The lower end of the BAT-AEL range is typically achieved when using filtration (e.g. sand filtration, microfiltration, ultrafiltration).
⁽⁸⁾ The upper end of the BAT-AEL range may be higher and up to 40 mg/l for gelatine manufacturing.
⁽⁹⁾ The BAT-AEL may not apply when the temperature of the waste water is low (e.g. below 12 °C) for prolonged periods.
⁽¹⁰⁾ The upper end of the BAT-AEL range may be higher and up to 40 mg/l for installations processing animal by-products and/or edible co-products only if the Total N abatement efficiency is ≥ 90 % as a yearly average or as an average over the production period.
⁽¹¹⁾ The BAT-AEL only applies when the substance/parameter concerned is identified as relevant in the waste water stream based on the inventory of inputs and outputs mentioned in BAT 2.
⁽¹²⁾ The BAT-AEL only applies to slaughterhouses.

The associated monitoring is given in BAT 7.

Table 5.2: BAT-associated emission levels (BAT-AELs) for indirect discharges

Substance/Parameter		Unit	BAT-AEL ⁽¹⁾ ⁽²⁾
Adsorbable organically bound halogens (AOX) ⁽³⁾		mg/l	0.02–0.3
Metals	Copper (Cu) ⁽³⁾		0.01–0.2 ⁽⁴⁾
	Zinc (Zn) ⁽³⁾		0.05–0.5 ⁽⁴⁾

⁽¹⁾ The averaging periods are defined in the general considerations.
⁽²⁾ The BAT-AELs may not apply if the downstream waste water treatment plant is designed and equipped appropriately to abate the pollutants concerned, provided this does not lead to a higher level of pollution in the environment.
⁽³⁾ The BAT-AEL only applies when the substance/parameter concerned is identified as relevant in the waste water stream based on the inventory of inputs and outputs mentioned in BAT 2.
⁽⁴⁾ The BAT-AEL only applies to slaughterhouses.

The associated monitoring is given in BAT 7.

5.1.8 Emissions to air

BAT 15. In order to reduce emissions to air of CO, dust, NO_x and SO_x from the combustion (e.g. in thermal oxidisers or steam boilers) of malodorous gases, including non-condensable gases, BAT is to use technique (a) and one or an appropriate combination of the techniques (b) to (d) given below.

	Technique	Description	Main compounds targeted	Applicability
a	Optimisation of thermal oxidation or combustion in boilers	Optimisation of design and operation of boilers or thermal oxidisers to promote the oxidation of organic compounds, as well as to reduce the generation of pollutants such as NO _x and CO.	CO, NO _x	Generally applicable.
b	Removal of high levels of dust, NO _x and SO _x precursors	Removal (if possible, for reuse) of high levels of dust, NO _x and SO _x precursors prior to combustion of malodorous gases or thermal oxidation, e.g. by condensation. Additional post-combustion removal of dust, NO _x and SO _x may be carried out using wet scrubbing for example.	Dust, NO _x , SO _x	
c	Fuel choice	The use of fuel (including support/auxiliary fuel) with a low content of potential pollution-generating compounds (e.g. low sulphur, ash, nitrogen, fluorine or chlorine content in the fuel).	Dust, NO _x , SO _x	
d	Low-NO _x burner	The technique is based on the principles of reducing peak flame temperatures. The air/fuel mixing reduces the availability of oxygen and reduces the peak flame temperature, thus retarding the conversion of fuel-bound nitrogen to NO _x and the formation of thermal NO _x , while maintaining high combustion efficiency. This may be associated with a modified design of the furnace combustion chamber.	NO _x	Applicability to existing plants may be restricted by design and/or operational constraints.

Table 5.3: BAT-associated emission levels (BAT-AELs) for channelled emissions to air of dust, NO_x and SO_x from the combustion in thermal oxidisers of malodorous gases, including non-condensable gases

Substance/Parameter	Unit	BAT-AEL (average over the sampling period)
Dust	mg/Nm ³	< 1–5 ⁽¹⁾
NO _x		50–200 ⁽¹⁾ ⁽²⁾
SO _x		6–100

⁽¹⁾ The BAT-AEL range only applies when using exclusively natural gas as a fuel.
⁽²⁾ The upper end of the BAT-AEL range may be higher and up to 350 mg/Nm³ for recuperative thermal oxidisers.

The associated monitoring is given in BAT 8.

Table 5.4: Indicative emission level for channelled CO emissions to air from the combustion in thermal oxidisers of malodorous gases, including non-condensable gases

Substance	Unit	Indicative emission level (average over the sampling period)
CO	mg/Nm ³	3–30

The associated monitoring is given in BAT 8.

5.1.9 Noise

BAT 16. In order to prevent or, where that is not practicable, to reduce noise emissions, BAT is to set up, implement and regularly review a noise management plan, as part of the environmental management system (see BAT 1), that includes all of the following elements:

- a protocol containing appropriate actions and timelines;
- a protocol for conducting noise emissions monitoring;
- a protocol for response to identified noise events, e.g. complaints;
- a noise reduction programme designed to identify the source(s), to measure/estimate noise exposure, to characterise the contributions of the sources and to implement prevention and/or reduction measures.

Applicability

The applicability is restricted to cases where a noise nuisance at sensitive receptors is expected and/or has been substantiated.

BAT 17. In order to prevent or, where that is not practicable, to reduce noise emissions, BAT is to use one or a combination of the techniques given below.

Technique	Description	Applicability	
a	Appropriate location of equipment and buildings	Increasing the distance between the emitter and the receiver, by using buildings as noise screens and by relocating equipment and/or buildings' exits or entrances.	For existing plants, the relocation of equipment and buildings' exits or entrances may not be applicable due to lack of space and/or excessive costs.
b	Operational measures	These include techniques such as: <ul style="list-style-type: none"> i. inspection and maintenance of equipment; ii. closing of doors and windows of enclosed areas, if possible; iii. equipment operation by experienced staff; iv. avoidance of noisy activities at night, if possible; v. provisions for noise control, e.g. during production and maintenance activities; vi. limitation of noise from animals in slaughterhouses (e.g. through careful transport and handling). 	Generally applicable.
c	Low-noise equipment	This includes techniques such as low-noise compressors, pumps and fans.	

Technique		Description	Applicability
d	Noise control equipment	This includes techniques such as: i. noise reducers; ii. acoustic insulation of equipment; iii. enclosure of noisy equipment; iv. soundproofing of buildings.	May not be applicable to existing plants due to lack of space.
e	Noise abatement	Inserting obstacles between emitters and receivers (e.g. protection walls, embankments).	Generally applicable.

5.1.10 Odour

BAT 18. In order to prevent or, where that is not practicable, to reduce odour emissions, BAT is to set up, implement and regularly review an odour management plan, as part of the environmental management system (see BAT 1), that includes all of the following elements:

- A protocol containing appropriate actions and timelines.
- A protocol for conducting odour monitoring. It may be complemented by measurement/estimation of odour exposure or estimation of odour impact.
- A protocol for response to identified odour incidents, e.g. complaints.
- An odour prevention and reduction programme designed to identify the source(s); to measure/estimate odour exposure; to characterise the contributions of the sources; and to implement prevention and/or reduction measures.

Applicability

The applicability is restricted to cases where an odour nuisance at sensitive receptors is expected and/or has been substantiated.

BAT 19. In order to prevent or, where that is not practicable, to reduce odour emissions, BAT is to use an appropriate combination of the techniques given below.

Technique		Description	Applicability
a.	Regular cleaning of installations and equipment	Regular cleaning (e.g. daily) of installations and equipment including areas where animal by-products and/or edible co-products are stored and processed.	Generally applicable.
b.	Cleaning and disinfection of vehicles and equipment used to transport and deliver animal by-products and/or edible co-products	Transport vehicles and delivery equipment (e.g. containers) are cleaned and disinfected after being emptied.	
c.	Enclosure of animal by-products and/or edible co-products during transport, reception, loading/unloading and storage	Loading/unloading and reception areas are situated in enclosed ventilated buildings. Appropriate equipment is used for transport and storage of the animal by-products and/or edible co-products.	May not be applicable to existing plants due to lack of space.
d.	Minimisation of biological degradation of animal by-products and/or edible co-products	See BAT 12 (a).	Generally applicable.
e.	Air extraction as close as possible to the point of odour generation.	Air extraction as close as possible to the point of odour generation with full or partial enclosure. Extracted air may be treated (see BAT 25).	Generally applicable.

BAT-AELs for channelled emissions to air of odour: see Table 5.10 and Table 5.11.

5.1.11 Use of refrigerants

BAT 20. In order to prevent emissions of ozone-depleting substances and of substances with a high global warming potential from cooling and freezing, BAT is to use refrigerants without ozone depletion potential and with a low global warming potential.

Description

Suitable refrigerants include for example water, carbon dioxide, propane and ammonia.

5.2 BAT conclusions for slaughterhouses

The BAT conclusions in this section apply in addition to the general BAT conclusions given in Section 5.1.

5.2.1 Energy efficiency

BAT 21. In order to increase energy efficiency, BAT is to use both of the techniques given in BAT 9 in combination with both of the techniques given below.

	Technique	Description	Applicability
a	Refrigeration management plan	See Section 5.4.3.	Generally applicable.
b	Techniques for efficient scalding of pigs and/or poultry	These include techniques such as: - steam scalding of pigs; - immersion scalding of pigs and/or poultry with optimised water flow systems.	Applicability to existing plants may be restricted by the plant layout/lack of space.

Table 5.5: BAT-associated environmental performance levels (BAT-AEPLs) for specific net energy consumption in slaughterhouses

Slaughtered animals	Unit ⁽¹⁾	Specific net energy consumption (yearly average) ⁽²⁾
Cattle	kWh/tonne of carcasses	116–240 ⁽³⁾
	kWh/animal	30–80 ⁽⁴⁾
Pigs	kWh/tonne of carcasses	65–370 ⁽⁵⁾
	kWh/animal	4–35 ⁽⁵⁾
Chickens	kWh/tonne of carcasses	170–490 ⁽⁵⁾
	kWh/animal	0.25–0.90 ⁽⁵⁾

⁽¹⁾ Either the BAT-AEPL expressed in kWh/tonne of carcasses or the BAT-AEPL expressed in kWh/animal applies.
⁽²⁾ The BAT-AEPLs refer to the exclusive slaughtering of the animals in question.
⁽³⁾ The upper end of the BAT-AEPL range may be higher and up to 415 kWh/tonne of carcasses if the specific net energy consumption includes energy consumed by FDM activities.
⁽⁴⁾ The upper end of the BAT-AEPL range may be higher and up to 150 kWh/animal if the specific net energy consumption includes energy consumed by FDM activities.
⁽⁵⁾ The BAT-AEPL range may not be applicable to installations producing more than 50 % convenience products (i.e. meat products processed further than simple meat cuts, e.g. marinated products, sausages) as a proportion of the total weight of the FDM products.

The associated monitoring is given in BAT 6.

5.2.2 Water consumption and waste water generation

BAT 22. In order to reduce water consumption and the amount of waste water generated, BAT is to use both techniques (a) and (b) given in BAT 10, together with an appropriate combination of the techniques (c) to (k) given in BAT 10 and of the techniques given below.

Technique		Description	Applicability
a	Dry emptying of cattle/pig stomachs	Cattle/pig stomachs are emptied by using machines without water.	Generally applicable.
b	Dry collection of the contents of pigs' small intestines	Pigs' small intestines are emptied by pulling them between a pair of rollers. Their content is collected in a tray and pumped to a container.	
c	Techniques for efficient scalding	See BAT 21 (b).	Applicability to existing plants may be restricted by the plant layout/lack of space.

Table 5.6: BAT-associated environmental performance levels (BAT-AEPLs) for specific waste water discharge

Slaughtered animals	Unit ⁽¹⁾	Specific waste water discharge (yearly average) ⁽²⁾
Cattle	m ³ /tonne of carcasses	1.85–3.90 ⁽³⁾
	m ³ /animal	0.30–1.30 ⁽⁴⁾
Pigs	m ³ /tonne of carcasses	0.70–3.50
	m ³ /animal	0.07–0.30
Chickens	m ³ /tonne of carcasses	1.45–6.30
	m ³ /animal	0.002–0.013

⁽¹⁾ Either the BAT-AEPL expressed in m³/tonne of carcasses or the BAT-AEPL expressed in m³/animal applies.
⁽²⁾ The BAT-AEPLs refer to the exclusive slaughtering of the animals in question.
⁽³⁾ The upper end of the BAT-AEPL range may be higher and up to 5.25 m³/tonne of carcasses in case the specific waste water discharge includes water used by FDM activities.
⁽⁴⁾ The upper end of the BAT-AEPL range may be higher and up to 2.45 m³/animal in case the specific waste water discharge includes water used by FDM activities.

The associated monitoring is given in BAT 6.

5.2.3 Use of refrigerants

BAT 23. In order to prevent or, where that is not practicable, to reduce refrigerant losses, BAT is to use technique (a) and one or both of the techniques (b) and (c) given below.

Technique		Description
a	Refrigeration management plan	See Section 5.4.3.
b	Preventive and corrective maintenance	The correct operation of the refrigeration equipment is regularly reviewed and any deviations/malfunctions are corrected/fixed in a timely manner.
c	Use of refrigerant leak detectors	A centralised alarm system is used in order to promptly identify refrigerant leaks.

Table 5.7: Indicative emission level for refrigerant losses

Type of refrigerant	Unit	Indicative emission level (rolling average over 3 years)
Any type of refrigerant	Percentage (%) of the total amount of refrigerant contained in the cooling system(s)	< 1-5

The associated monitoring is given in BAT 6.

5.3 BAT conclusions for installations processing animal by-products and/or edible co-products

The BAT conclusions in this section apply in addition to the general BAT conclusions given in Section 5.1.

5.3.1 Energy efficiency

BAT 24. In order to increase energy efficiency, BAT is to use both of the techniques given in BAT 9, if appropriate in combination with multiple-effect evaporators.

Description

Multiple-effect evaporators are used to remove water from liquid mixtures generated for example in fat melting, rendering, and fishmeal and fish oil production. Steam is introduced in a series of successive vessels, each one exhibiting a lower temperature and pressure than the previous one.

Table 5.8: BAT-associated environmental performance levels (BAT-AEPLs) for specific net energy consumption in installations processing animal by-products and/or edible co-products

Type of installation/process(es)	Unit	Specific net energy consumption (yearly average)
Rendering, fat melting, blood and/or feather processing	kWh/tonne of raw material	120–910
Fishmeal and fish oil production		420–710
Gelatine manufacturing		1 380–2 500 ⁽¹⁾

⁽¹⁾ The BAT-AEPL applies to installations using exclusively pig skin as raw material.

The associated monitoring is given in BAT 6.

5.3.2 Water consumption and waste water generation

The environmental performance levels for specific waste water discharge given below are associated with the general BAT conclusions described in Section 5.1.4.

Table 5.9: BAT-associated environmental performance levels (BAT-AEPLs) for specific waste water discharge

Type of installation/process(es)	Unit	Specific waste water discharge (yearly average)
Rendering, fat melting, blood and/or feather processing	m ³ /tonne of raw material	0.2–1.55
Fishmeal and fish oil production		0.20–1.25 ⁽¹⁾
Gelatine manufacturing		16.5–27 ⁽²⁾

⁽¹⁾ The BAT-AEPL range may not apply for discharges of seawater from fishmeal and fish oil production.
⁽²⁾ The BAT-AEPL applies to installations using exclusively pig skin as raw material.

The associated monitoring is given in BAT 6.

5.3.3 Emissions to air

BAT 25. In order to reduce emissions to air of organic compounds and malodorous compounds, including H₂S and NH₃, BAT is to use one or a combination of the techniques given below.

Technique		Description
a.	Condensation	See Section 5.4.2. The technique is used together with one or a combination of the techniques (b) to (g) for the treatment of non-condensable gases. See Section 5.4.2.
b.	Adsorption	
c.	Biofilter	
d.	Combustion in a steam boiler of malodorous gases, including non-condensable gases	
e.	Thermal oxidation	
f.	Wet scrubber	
g.	Bioscrubber	

Table 5.10: BAT-associated emission levels (BAT-AELs) for channelled emissions to air of odour, organic compounds, NH₃ and H₂S from rendering, fat melting, blood and/or feather processing

Substance/Parameter	Unit	BAT-AEL
Odour concentration	ou _E /m ³	200–1 100 ⁽¹⁾ ⁽²⁾
TVOC	mg C/Nm ³	0.5–16
NH ₃	mg/Nm ³	0.1–4 ⁽³⁾
H ₂ S		< 0.1–1 ⁽⁴⁾

⁽¹⁾ The BAT-AEL range may not apply in the case of combustion (e.g. in thermal oxidisers or steam boilers) of malodorous gases when both of the following conditions are fulfilled:

- the combustion temperature is sufficiently high (typically in the range 750-850 °C) with a sufficient residence time (typically between 1 and 2 seconds); and
- the odour abatement efficiency is ≥ 99 %, or as an alternative, process odour is not perceptible in the treated waste gases.

⁽²⁾ In the case of abatement technique(s) other than combustion of malodorous gases, the upper end of the BAT-AEL range may be higher and up to 3 000 ou_E/m³ if the abatement efficiency is ≥ 92 % or, as an alternative, process odour is not perceptible in the treated waste gases.

⁽³⁾ The upper end of the BAT-AEL range may be higher and up to 7 mg/Nm³ in the case of combustion (e.g. in thermal oxidisers or steam boilers) of malodorous gases.

⁽⁴⁾ The BAT-AEL range only applies when H₂S is identified as relevant in the waste gas stream based on the inventory of inputs and outputs mentioned in BAT 2.

The associated monitoring is given in BAT 8.

Table 5.11: BAT-associated emission levels (BAT-AELs) for channelled emissions to air of odour, organic compounds and NH₃ from fishmeal and fish oil production

Substance/Parameter	Unit	BAT-AEL
Odour concentration	ou _E /m ³	400–3 500 ⁽¹⁾
TVOC ⁽²⁾	mg C/Nm ³	1–14
NH ₃ ⁽²⁾	mg/Nm ³	0.1–7
<p>⁽¹⁾ The BAT-AEL range may not apply in the case of combustion (e.g. in thermal oxidisers or steam boilers) of malodorous gases when both of the following conditions are fulfilled:</p> <ul style="list-style-type: none"> the combustion temperature is sufficiently high (typically in the range 750-850 °C) with a sufficient residence time (typically between 1 and 2 seconds) and; the odour abatement efficiency is ≥ 99 % or, as an alternative, process odour is not perceptible in the treated waste gases. <p>⁽²⁾ The BAT-AEL only applies to the combustion (e.g. in thermal oxidisers or steam boilers) of malodorous gases, including non-condensable gases.</p>		

The associated monitoring is given in BAT 8.

5.4 Description of techniques

5.4.1 Emissions to water

Technique	Description
Activated sludge process	A biological process in which the microorganisms are maintained in suspension in the waste water and the whole mixture is mechanically aerated. The activated sludge mixture is sent to a separation facility from where the sludge is recycled to the aeration tank.
Aerobic lagoon	Shallow earthen basin for the biological treatment of waste water, the content of which is periodically mixed to allow oxygen to enter the liquid through atmospheric diffusion.
Anaerobic contact process	An anaerobic process in which waste water is mixed with recycled sludge and then digested in a sealed reactor. The water/sludge mixture is separated externally.
Chemical oxidation (e.g. with ozone)	Chemical oxidation is the conversion of pollutants by chemical-oxidising agents other than oxygen/air or bacteria into similar but less harmful or hazardous compounds and/or to short-chained and more easily degradable or biodegradable organic components. Ozone is one example of a chemical-oxidising agent applied.
Coagulation and flocculation	Coagulation and flocculation are used to separate suspended solids from waste water and are often carried out in successive steps. Coagulation is carried out by adding coagulants with charges opposite to those of the suspended solids. Flocculation is carried out by adding polymers, so that collisions of microfloc particles cause them to bond to produce larger flocs.
Equalisation	Balancing of flows and pollutant loads by using tanks or other management techniques.
Enhanced biological phosphorus removal	A combination of aerobic and anaerobic treatment to selectively enrich polyphosphate-accumulating microorganisms in the bacterial community within the activated sludge. These microorganisms take up more phosphorus than is required for normal growth.
Filtration	The separation of solids from waste water by passing it through a porous medium, e.g. sand filtration, microfiltration and ultrafiltration.
Flotation	The separation of solid or liquid particles from waste water by attaching them to fine gas bubbles, usually air. The buoyant particles accumulate at the water surface and are collected with skimmers.
Membrane bioreactor	A combination of activated sludge treatment and membrane filtration. Two variants are used: a) an external recirculation loop between the activated sludge tank and the membrane module; and b) immersion of the membrane module in the aerated activated sludge tank, where the effluent is filtered through a hollow fibre membrane, with the biomass remaining in the tank.
Neutralisation	The adjustment of the pH of waste water to a neutral level (approximately 7) by the addition of chemicals. Sodium hydroxide (NaOH) or calcium hydroxide (Ca(OH) ₂) is generally used to increase the pH, whereas sulphuric acid (H ₂ SO ₄), hydrochloric acid (HCl) or carbon dioxide (CO ₂) is generally used to decrease the pH. The precipitation of some substances may occur during neutralisation.
Nitrification and/or denitrification	A two-step process that is typically incorporated into biological waste water treatment plants. The first step is the aerobic nitrification where microorganisms oxidise ammonium (NH ₄ ⁺) to the intermediate nitrite (NO ₂ ⁻), which is then further oxidised to nitrate (NO ₃ ⁻). In the subsequent anoxic denitrification step, microorganisms chemically reduce nitrate to nitrogen gas.
Phosphorus recovery as struvite	Phosphorus contained in waste water streams is recovered by precipitation in the form of struvite (magnesium ammonium phosphate).

Technique	Description
Precipitation	The conversion of dissolved pollutants into insoluble compounds by adding chemical precipitants. The solid precipitates formed are subsequently separated by sedimentation, air flotation, or filtration. Multivalent metal ions (e.g. calcium, aluminium, iron) are used for phosphorus precipitation.
Sedimentation	The separation of suspended particles by gravitational settling.

5.4.2 Emissions to air

Technique	Description
Adsorption	Organic compounds are removed from a waste gas stream by retention on a solid surface (typically activated carbon).
Bag filter	Bag filters, often referred to as fabric filters, are constructed from porous woven or felted fabric through which gases are passed to remove particles. The use of a bag filter requires the selection of a fabric suitable for the characteristics of the waste gas and the maximum operating temperature.
Biofilter	The waste gas stream is passed through a bed of organic material (such as peat, heather, compost, root, tree bark, softwood and different combinations) or some inert material (such as clay, activated carbon, and polyurethane), where it is biologically oxidised by naturally occurring microorganisms into carbon dioxide, water, inorganic salts and biomass. A biofilter is designed considering the type(s) of waste input. An appropriate bed material, e.g. in terms of water retention capacity, bulk density, porosity, structural integrity, is selected. Also important are an appropriate height and surface area of the filter bed. The biofilter is connected to a suitable ventilation and air circulation system in order to ensure a uniform air distribution through the bed and a sufficient residence time of the waste gas inside the bed. Biofilters can be divided into open-top biofilters and enclosed biofilters.
Bioscrubber	A packed tower filter with inert packing material which is normally continuously moistened by sprinkling water. Air pollutants are absorbed in the liquid phase and subsequently degraded by microorganisms settling on the filter elements.
Combustion in a steam boiler of malodorous gases, including non-condensable gases	Malodorous gases, including non-condensable gases, are burned in a steam boiler in the installation.
Condensation	The removal of vapours of organic and inorganic compounds from a process off-gas or waste gas stream by reducing its temperature below its dew point so that the vapours liquefy.
Thermal oxidation	The oxidation of combustible gases and odorants in a waste gas stream by heating the mixture of contaminants with air or oxygen to above its auto-ignition point in a combustion chamber and maintaining it at a high temperature long enough to complete its combustion to carbon dioxide and water.
Wet scrubber	The removal of gaseous or particulate pollutants from a gas stream via mass transfer to a liquid solvent, often water or an aqueous solution. It may involve a chemical reaction (e.g. in an acid or alkaline scrubber). In some cases, the compounds may be recovered from the solvent.

5.4.3 Use of refrigerants

Refrigeration management plan	<p>A refrigeration management plan is part of the environmental management system (see BAT 1) and entails:</p> <ul style="list-style-type: none">- monitoring of energy consumption of the refrigeration system (see BAT 6);- operational measures such as inspection and maintenance of equipment, closing of doors when possible; equipment operation by experienced staff;- monitoring of refrigerant losses (see BAT 6).
-------------------------------	--

6 EMERGING TECHNIQUES

Article 3(14) of Directive 2010/75/EU defines an ‘emerging technique’ as a ‘novel technique for an industrial activity that, if commercially developed, could provide either a higher general level of protection of the environment or at least the same level of protection of the environment and higher cost savings than existing best available techniques’. This chapter contains those techniques that may appear in the near future and that may be applicable to slaughterhouses and installations processing animal by-products and/or edible co-products.

6.1 General

6.1.1 Microalgal heterotrophic bioreactors

Technical description

Microalgal heterotrophic bioreactors convert organic matter, nitrogen and phosphorus in waste water into biomass suitable for energy production (e.g. biodiesel). SA waste water generally has a high pollutant load and a high concentration of organic matter in the right ratios (ideal C/N and N/P ratio), which, combined with the absence of toxic compounds or growth inhibitors, will make it a suitable environment for heterotrophic microalgal cultivation. The core of the process is the conversion of COD, N-TKN and P- PO_4^{3-} into microalgal biomass. Inside the bioreactor, the heterotrophic microalgal cultivation is driven by sunlight and CO_2 , and produces microalgal biomass composed of lipids, fatty acids, proteins, and pigments. As illustrated in Figure 6.1, after the production of biomass, there is no separation of the streams. The right-hand side of Figure 6.1 indicates the composition of biomass. The analysis of the biomass is done after processing in a decanter, a belt filter, and a drum dryer to separate the different streams.

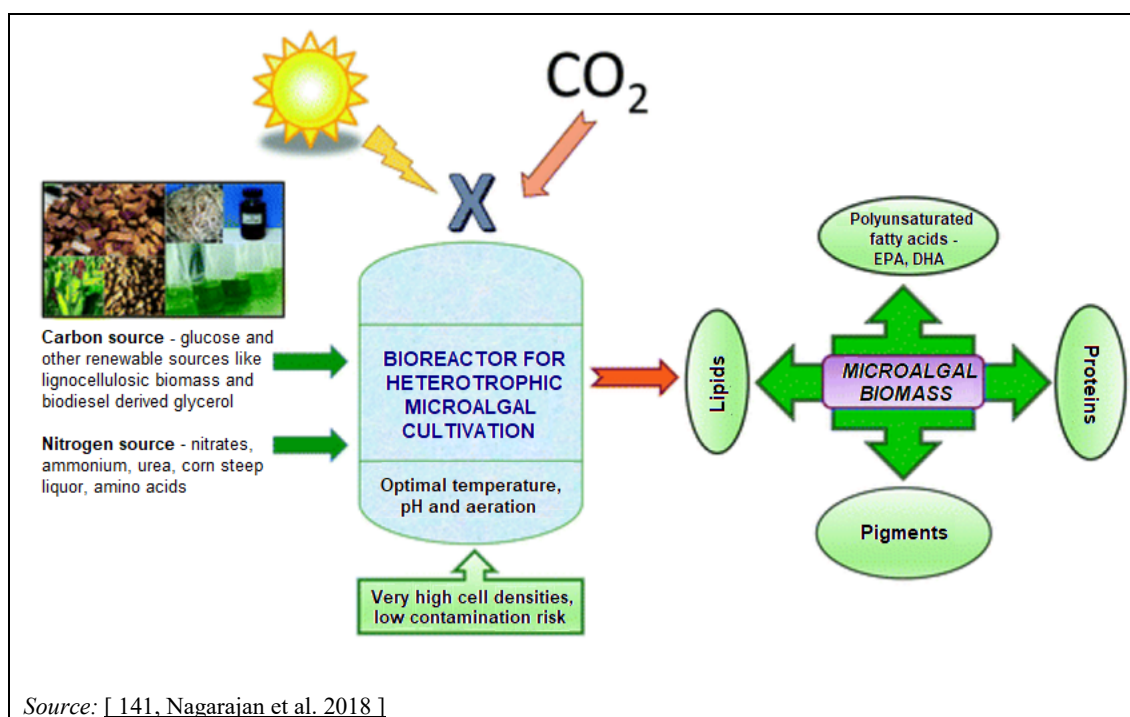

Figure 6.1: Process of heterotrophic microalgal cultivation

The chemical composition of microalgal sludge is as follows: protein (32 %), lipids (15 %), carbohydrates (16 %), minerals (22 %) and moisture (15 %). Sludge with this composition qualifies as a potential source of single-cell proteins and oils to feed biorefineries.

Achieved environmental benefits

- Requires low energy input.
- Contributes to the partial removal of nitrogen and phosphorus from waste water.

Environmental performance and operational data

The study [142, Santos et al. 2017], analysing the treatment of poultry and swine slaughterhouse waste water, showed removal efficiencies of 97.6 %, 85.5 % and 92.4 % for COD, N-TKN and P-PO₄³⁻, respectively. In addition, a microalgal sludge productivity of 0.27 kg/m³/d was observed.

Technical considerations relevant to applicability

The maintenance of a monoculture of heterotrophic microalgae is expensive and technically difficult to operate at full scale [143, Jacob-Lopes et al. 2013].

Economics

Economic data were available from a bench-scale facility, and were extrapolated to estimate the costs of an industrial scale with a capacity of 16 000 m³/day. The economic analysis demonstrated a cost of USD 2.66/m³ of treated industrial waste water, and, as a consequence of this process, the production cost of microalgal sludge was USD 0.03/kg of dehydrated biomass [142, Santos et al. 2017].

Driving force for implementation

Microalgal sludge is a rich biomass that can be used for animal feed and bioenergy production.

Example plants

A pilot algal system has been installed in a multispecies slaughterhouse (pigs, cattle, sheep and goats) in Salteras (Spain) covered by the SA BREF scope, consisting of a 400 m² main algal pond and two 9 m² inoculation ponds for maintaining the inoculum culture. All ponds have a fully automated control system measuring the input and output parameters of the water substrate. The biomass produced is harvested by sedimentation and dissolved air flotation. A CO₂ diffuser is employed to optimise CO₂ dispersion into the algal ponds. This algal system has been developed in the context of the Water2Return project funded by the European Commission [175, Water2Return 2019].

Reference literature

[141, Nagarajan et al. 2018], [142, Santos et al. 2017], [143, Jacob-Lopes et al. 2013], [147, COM 2019], [175, Water2Return 2019].

6.1.2 Microbial fuel cells

Technical description

Microbial fuel cells (MFCs) are devices that use bacteria as a catalyst for converting organic matter into electricity. A microbial fuel cell usually consists of two chambers: one anaerobic anodic chamber (left side in Figure 6.2) and one aerobic cathodic chamber (right side in Figure 6.2), separated by ion-conducting separators (Proton Exchange Membrane, PEM). Bacteria which are capable of extracellular electron transfer – called electricigens – will oxidise substrates in the anode chamber and generate electrons (e⁻) and protons (H⁺) which will flow to the anode (see Equation 1). Electrons will move to the cathode via an external circuit and generate electricity, while the protons will transfer via the PEM. In the cathode chamber (usually made of platinum), electrons, protons and O₂ will then combine to form water (see Equation 2) [145, Ismail et al. 2016].

The following reactions occur:

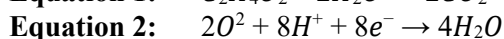
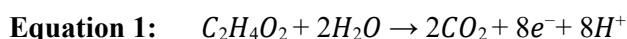

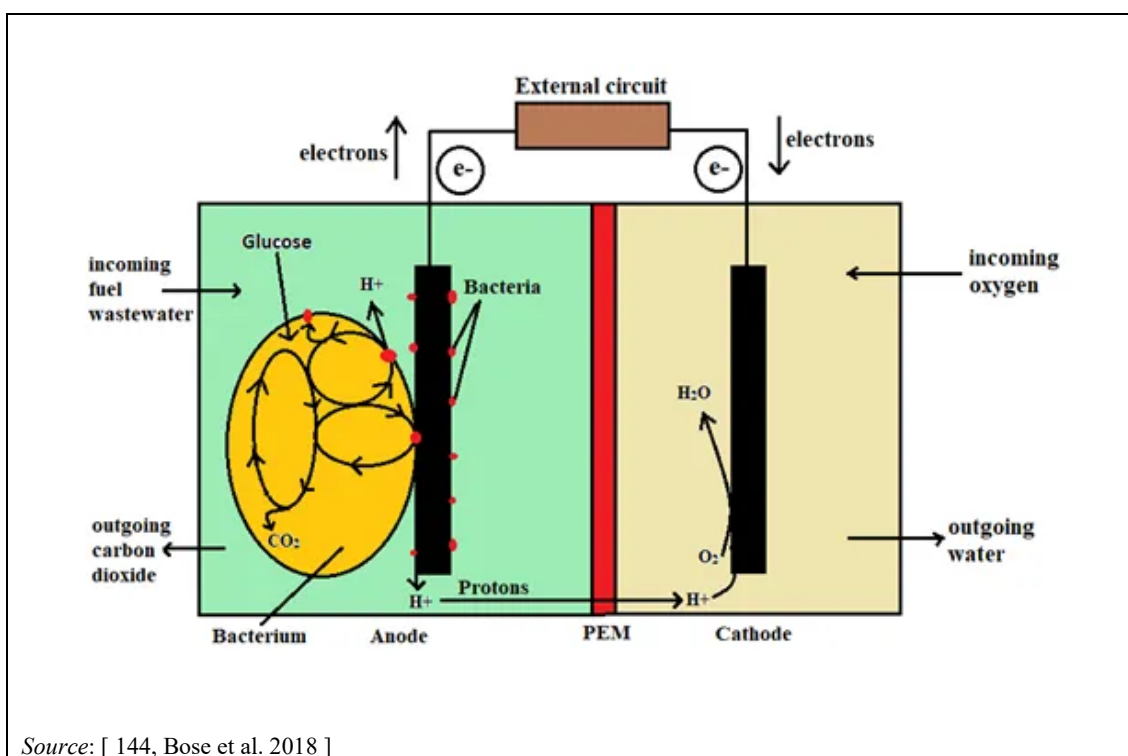

Figure 6.2: Schematic diagram of microbial fuel cells with PEM

Achieved environmental benefits

- Renewable energy production.
- Reduction of COD, BOD, TSS and total nitrogen content in waste water.

Environmental performance and operational data

The maximum power density generated is around 700 MW/m². Reductions in the concentrations of waste water pollutants in a slaughterhouse are shown in Table 6.1.

Table 6.1: Reduction of concentration of waste water pollutants after treatment by MFC

Waste water parameter	Before MFC treatment (mg/l)	After MFC treatment ⁽¹⁾ (mg/l)	Reduction (%)
COD	9 350	1 079	-88
BOD	2 600	895	-66
TSS	3 250	1 824	-44
Ammonia	1.2	0.48	-60
Phosphate	480	739	+54 ⁽²⁾
Total nitrogen	1.05	0.42	-60

⁽¹⁾ Using 0.1 M potassium ferricyanide as catholyte.
⁽²⁾ Low redox potential could lead to release of inorganic phosphate from organic matter.
Source: [146, Akaluka et al. 2016]

A possible explanation for the increase in phosphate concentration may be that the low redox potential in the anode cells leads to a release of inorganic phosphate from organic matter [147, COM 2019].

Cross-media effects

- Mining and usage of precious metals such as copper, graphite, zinc and platinum for the production of efficient cathodes.
- Metals are wasted in the use of cathodes.

Technical considerations relevant to applicability

Studies have shown that scaling up causes a decreased power output [148, Chaturvedi et al. 2016]. Because electrodes' size increases, the distance between the electrodes changes disproportionately and renders the MFC bulkier and less efficient. This is a major drawback for its large-scale commercialisation potential. There are also parameters which have to be adjusted, such as size and shape of electrodes, electrode material, and device configuration, which can make the implementation of this treatment method difficult in practice.

Economics

Electrodes are known to be expensive since these are not produced industrially yet and the material with which they are made (graphite, copper, zinc, platinum) is not cheap. The membranes separating the two chambers are usually made of nylon, which is also costly.

Driving force for implementation

Electricity production from contaminants specifically found in slaughterhouse waste water.

Reference literature

[144, Bose et al. 2018], [145, Ismail et al. 2016], [146, Akaluka et al. 2016], [147, COM 2019], [148, Chaturvedi et al. 2016].

6.1.3 UV photooxidation

Technical description

UV photooxidation is a process to reduce VOCs and to eliminate odour emissions from exhaust air.

In the process of photooxidation (Figure 6.3), the exhaust air stream is passed through a droplet separator (TA1) and a particle filter (F1) for conditioning if required. In the UV reactor (R1), the exhaust air is then irradiated with high-energy UV-C light to degrade VOCs and to eliminate odour. Excess ozone and possible residuals of pollutants are removed in a downstream activated carbon filter (R2). A fan (V1) installed on the suction side provides the necessary negative pressure to promote the volume flow.

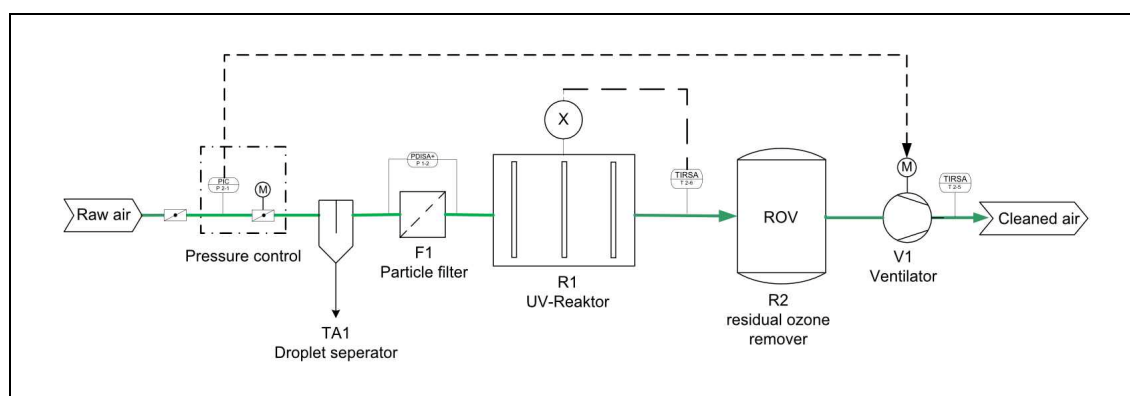

Figure 6.3: Direct photooxidation

The irradiation of the pollutants leads to their oxidation, whereby they are decomposed and rendered harmless. The oxidation induced by light energy is based on three different reactions:

1. During photolysis, the intra-molecular bonds of the pollutant molecules get excited and split by the emitted photons. Photolysis takes place if the binding energy of the pollutant molecules corresponds to the emitted light energy. This energy is specific for every molecule and varies in a bright range.

Photolysis: $R-R + h\nu \rightarrow R\cdot + R\cdot$

- The radiation emitted by the UV emitter of 185 nm leads to the dissociation of atmospheric oxygen. The atomic oxygen generated forms ozone (O_3) by reaction with other oxygen molecules from the ambient air or directly oxidises a pollutant molecule and thus supports the degradation of the pollutants by the photolysis described above.

Ozone formation: $O_2 + h\nu \rightarrow 2/3 O_3 \rightarrow 2O\cdot$

- Water molecules (H_2O) contained in the exhaust gas stream are split by photons emitted from the UV lamps into OH radicals ($OH\cdot$), which also contribute to the oxidation of the pollutants and their decomposition.

Formation of OH radicals: $H_2O + h\nu \rightarrow OH\cdot + H\cdot$

The velocity of these reactions is specific for each substance and depends on its concentration. This cannot be calculated exactly for mixtures of substances. In order to ensure the degradation of pollutants, the system is operated with an overstoichiometric ozone content and higher radiation power.

Irradiation power can be adjusted in the event of a reduction of the raw gas volume flow by varying the number of UV emitters or by electronic dimming of the lamps. This control system is also used to reduce the energy consumption of the system to a minimum even with the same raw gas volume with a lower pollutant concentration.

In comparison to biofilters, less space is needed, and less surface is sealed.

Achieved environmental benefits

The process of UV photooxidation combined with activated carbon filters is used to reduce the emission of contaminants like VOCs and odour from industrial exhaust air. The unspecific oxidation and adsorption are used to eliminate organic compounds like mercaptans, cadaverin, and other organo-sulphur compounds as well as inorganic compounds like hydrogen sulphide and other sulphides. Toxic and carcinogenic compounds such as formaldehyde are degraded to carbon dioxide and water.

Environmental performance and operational data

No information provided.

Cross-media effects

Electricity use is estimated to be between 2 kWh/m³ and 3 kWh/m³ for odour elimination from exhaust air streams. The photochemically generated ozone does not leave the system due to the activated carbon filter installed downstream.

Technical considerations relevant to applicability

Exhaust air treatment plants using photooxidation and activated carbon filters can be installed in a very small area. In the case of limited space, the activated carbon filter can be positioned above the UV reactor to reduce the required footprint. Two or more systems can also be erected on top of each other.

The physical processes of photooxidation are well known, but the degradation products of pollutant mixtures from exhaust air can be complex. Tests with a pilot plant are therefore required to determine the optimal operating parameters (e.g. radiation intensity and dwell time) of the UV reactor for a specific exhaust air.

If ammonia is contained in the exhaust air an additional preinstalled scrubber is necessary to remove it.

The combined physical process of photooxidation with a downstream activated carbon filter is independent of weather conditions, the ambient temperature, and the humidity of the environment. With the possibility of reducing or increasing the UV radiation intensity, even peak loads of pollutants can be treated successfully to avoid a breakthrough of VOC- or odour-intensive exhaust air. This dynamic mode of operation, in correlation to the load or concentration of pollutants, enables a high energy efficiency of the process and reduces the energy consumption and CO₂ emissions to a minimum.

No other consumables are needed except for electricity, activated carbon and UV lamps. Except the loaded activated carbon and the used UV lamps, no other solid or liquid waste is produced. The loaded activated carbon can be regenerated or used as substitute fuel in thermal energy production.

Economics

The energy consumption per treated m³ of exhaust air depends on the composition and the concentration of the pollutants. In general, the average energy consumption of the UV reactor is between 2 kWh/m³ and 3 kWh/m³. The service life of the UV lamps is between 9 000 and 12 000 operating hours.

If ammonia is contained in the exhaust air an additional preinstalled scrubber is necessary to remove it, the operation of which incurs further costs.

Depending on the loads of the pollutants, the activated carbon must be changed once or twice a year. The cost of disposal depends on the loading of the activated carbon and the type of pollutants.

Driving force for implementation

- Reduction of operational costs due to dynamic driving style by dimming UV lamps or partly switching off UV emitters.
- Low space requirement of exhaust air treatment systems to achieve guaranteed compliance with the limit values independent of weather phenomena, ambient temperature and humidity.

Example plants

No information provided.

Reference literature

[211, TWG 2023].

6.2 Emerging techniques for slaughterhouses

6.2.1 Superchilling

Technical description

This is a cooling technique characterised by a product temperature which is lowered to just below its freezing point. Superchilling technology combines the favourable effect of low temperatures with the conversion of some water into ice, making it less prone to deteriorative processes. At the surface, ice is formed and will absorb heat from the interior of the meat until it eventually reaches equilibrium. Superchilling gives the meat an internal ice reservoir, so that there is no need for external ice around the product during storage or transportation for short periods. To put it into perspective, superchilling is positioned between refrigeration (conventional chilling) and freezing.

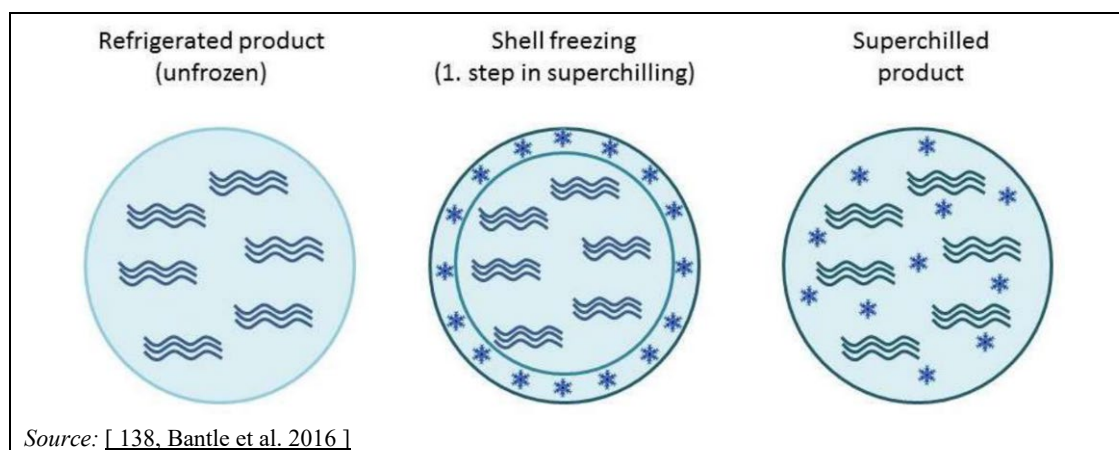

Figure 6.4: The different steps in superchilling

There are various superchilling technologies, each with their own advantages and limitations. The most common techniques are mechanical, cryogenic and impingement freezing [139, Kaale et al. 2011].

Mechanical freezing: This involves using a traditional circulating refrigerant such as carbon dioxide or ammonia to achieve a temperature reduction by heat exchange from air to the food product. They usually take the form of belt freezers to freeze foods, and have lower operational costs than cryogenic freezers, but require longer processing times due to low heat transfer coefficients.

Cryogenic freezing: This involves immersing or spraying the food directly with carbon dioxide or liquid nitrogen. This offers shorter freezing times compared to conventional air freezing because of the large temperature differences between the food and the cryogen ($-78\text{ }^{\circ}\text{C}$ for carbon dioxide as a solid or $-196\text{ }^{\circ}\text{C}$ for liquid nitrogen). There may however be some distortion of the shape of the product due to the cryogenic process.

Impingement freezing: This involves using thousands of high-velocity impingement air jets to direct air towards the bottom and top surfaces of a product. Products are placed on conveyor belts, and the high-velocity air passes through the conveyor upwards and downwards, and blasts away the boundary layer of air which holds heat around the product, increasing heat transfer rates compared to traditional mechanical freezers.

Superchilling remains a grey area in terms of international legislation because superchilled food is neither chilled nor frozen. Superchilled meat is not defined within EU legislation. Only chilled ($<4\text{ }^{\circ}\text{C}$ for poultry meat), frozen $<-12\text{ }^{\circ}\text{C}$ and deep-frozen ($<-18\text{ }^{\circ}\text{C}$) are defined. The

operational temperatures of superchilling are just below the freezing temperature of the products: e.g. -2 °C for pork roasts, -3.5 °C for cured loin, -1.1 °C for pork legs.

Achieved environmental benefits

Lower energy consumption compared to freezing.

Environmental performance and operational data

The energy consumption required for superchilling represents approximately one third of the energy needed for traditional freezing. Refrigerant consumption is higher than 1 kg N₂ per kg of processed product [139, Kaale et al. 2011].

Selecting optimal process conditions (temperature, velocity of the conveyor belt and holding time in the superchilling unit) to achieve the longest shelf life without compromising product quality is relevant. Also, controlling the amount of ice formation seems to be critical.

Technical considerations relevant to applicability

The influence of this technique on the microbiological quality of the meat is very important and needs to be investigated.

Driving force for implementation

- Relatively short implementation period in existing production lines [138, Bantle et al. 2016].
- Prolongs the shelf life for a meat product by 1.4 to 4 times compared to conventional meat-chilling methods [140, Bonou et al. 2016].

Example plants

Two processing lines for superchilling of fish and meat products have been implemented in the Norwegian food industry [138, Bantle et al. 2016].

Reference literature

[138, Bantle et al. 2016], [139, Kaale et al. 2011], [140, Bonou et al. 2016], [147, COM 2019].

6.2.2 Recycling of water in chickens' feet line

Description

Using water fit for purpose by reusing heated process water in an earlier process step.

Technical description

The feet-processing in chicken slaughterhouses consists of scalding, de-skinning and cooling the chickens' feet. The de-skinning step takes place in two vats, which are separated and contain separate volumes of water. To conserve water and energy, a filter between the two vats was installed, and the water from the last de-skinning vat was filtered and pumped to the first de-skinning vat. At the same time, the temperature in the second process step was reduced from 55 °C to 35 °C, contributing to the energy saving.

Reusing water in an earlier step within the same process can be done in compliance with food hygiene legislation.

Achieved environmental benefits

Reduction of water consumption.

Environmental performance and operational data

Reusing heated process water in an earlier process step saves water and energy. The example plant saved 50 % of the process water, amounting to 20 000-25 000 m³/year. The energy saving

amounted to 300 000 kWh/year. The installed system must be cleaned and disinfected together with all other production equipment which uses detergents and disinfectants.

Cross-media effects

None.

Technical considerations relevant to applicability

The technique can be used where the de-skinning process is done in two separate vats.

Economics

At a Danish chicken slaughterhouse slaughtering 190 000 chickens per day, the system was installed at a capital cost of EUR 33 500. The benefits of water and energy savings reduced the payback time to a few months. Running costs are low.

Driving force for implementation

In the example plant, reductions in the use of tap water as the slaughterhouse was running at maximum intake.

Example plants

One Danish chicken slaughterhouse (DK093).

Reference literature

[204, TWG 2021].

6.3 Emerging techniques for installations processing animal by-products and/or edible co-products

6.3.1 Hydrothermal liquefaction

Technical description

Hydrothermal liquefaction (HTL) is a biomass decomposition and valorisation method, comparable to gasification and pyrolysis. It is a process that uses hot (300-400 °C), pressurised condensed water (40-200 bar) to convert biomass into a thermally stable oil product, also known as biocrude, which can then be thermocatalytically upgraded to hydrocarbon fuel blendstocks, as illustrated in Figure 6.5.

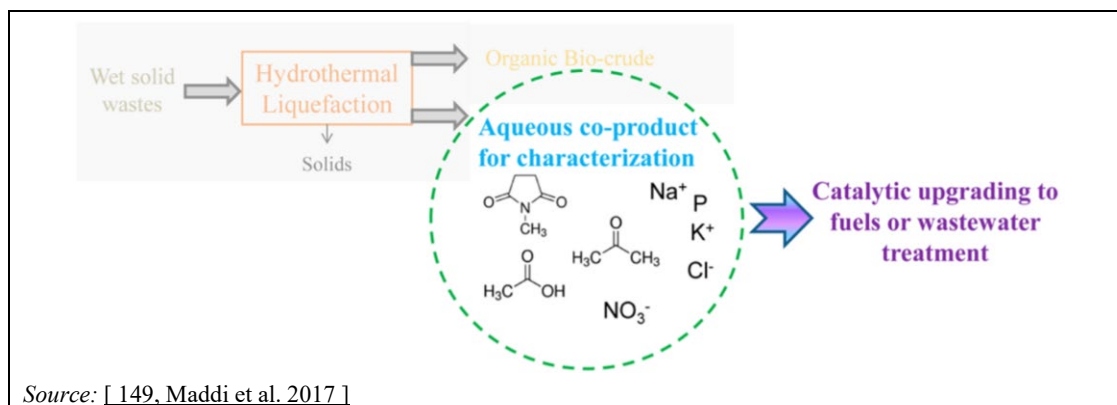

Source: [149, Maddi et al. 2017]

Figure 6.5: Flow of the hydrothermal liquefaction process

HTL accelerates the natural decomposition of organic matter to generate high-added-value hydrocarbons (biocrude oil) from a relatively wet biomass in the presence of a catalyst and hydrogen in a few minutes. A typical product may contain 10-73 wt-% biocrude oil, 8-20 wt-% gas, and 0.2-0.5 wt-% char. This biocrude oil produced contains less oxygen than bio-oil produced by pyrolysis. Researchers from the University of Alicante demonstrated in a lab-scale experiment that animal by-products can be used as raw material for the production of biocrude oil [150, García Cortés 2020].

Achieved environmental benefits

Advantages of this technique over traditional pyrolysis are:

- less energy consumption (because there is no need to dry the sample);
- better separation between the bio-oil and the water phase;
- bio-oil has lower O₂, sulphur and water content compared to pyrolysis oil.

In the specific case of using algal biomass as input [151, Gollakota et al. 2018], the environmental benefits are the following:

- reduced waste disposal;
- energy efficiency of 85-90 %;
- treatment of all biomasses from different origins (e.g. slaughterhouse waste can be added to the waste of a dairy production plant).

Cross-media effects

Nitrogen compounds are problematic for hydrotreatment catalysts and their presence in the bio-oil causes NO_x emissions.

Technical considerations relevant to applicability

Continuous reactors are required, while the majority of the knowledge is based on batch reactors. The thick walls of the pressure vessels together with a high feed viscosity result in low heat transfer efficiency. High-pressure (> 20 MPa) slurry feed pumps are not readily available. The chemistry of HTL is difficult to understand; therefore, it can be very challenging to use complex biomass, as is the case of slaughterhouse waste [152, Lee et al. 2016].

Economics

For a HTL plant with a feed rate of 7.9 l/h, the capital cost is around US 36 million. The biocrude production is estimated at 4.1 million Gasoline Gallon Equivalent (GGE)/year with a minimum selling price of USD 2.35/GGE biocrude (minimum revenue of USD 9.6 million/year) [153, Snowden-Swan et al. 2017]. This simulation is based on a mixture of waste water. There are no data available for the HTL method for slaughterhouse waste water because there are no large-scale plants in operation at the time of writing.

Reference literature

[147, COM 2019], [150, García Cortés 2020], [151, Gollakota et al. 2018], [152, Lee et al. 2016], [153, Snowden-Swan et al. 2017].

7 CONCLUDING REMARKS AND RECOMMENDATIONS FOR FUTURE WORK

Timing of the review process

The key milestones of the SA BREF review process are summarised in Table 7.1 below.

Table 7.1: Key milestones of the SA BREF review process

Key milestone	Timing
TWG reactivation	July 2018
Call for wishes	December 2018
Kick-off meeting	25-28 June 2019
Data and information collection	January-April 2020
Draft 1 (D1) of the revised SA BREF	June 2021
Commenting period (1 271 comments received)	June-October 2021
Revised proposals for the draft BAT conclusions and Background Paper for the Final TWG Meeting	September 2022
Final TWG meeting	28 November-2 December 2022

During the BREF review process, a total of 19 plants were visited in Belgium, Denmark, France, Germany and the Netherlands.

In addition, the following events were organised by the EIPPCB to improve the exchange of information:

- Workshop to finalise the questionnaire template (November 2019);
- 1st data assessment workshop (September 2020);
- 2nd data assessment workshop (March 2022);
- Informal workshop (on odour and the interface with the Medium Combustion Plant Directive) (June 2022).

Sources of information and information gaps

The main sources of information for the review process were:

- scientific and technical literature;
- 206 filled-in questionnaires (without confidential business information) from operators of SA industry plants;
- additional information from SA TWG members;
- 1 271 comments on Draft 1 of the revised SA BREF;
- 248 comments on the revised version of the draft BAT conclusions (September 2022);
- information gathered from site visits;
- outcomes of the workshops mentioned above.

In total, approximately 200 documents have been posted in BATIS, and most of them have been referenced in the revised SA BREF.

Degree of consensus reached during the information exchange

At the Final TWG Meeting that took place in hybrid format (in person and online) on 28 November 2022 to 2 December 2022, a high degree of consensus was reached on most of the BAT conclusions. However, 13 split views were expressed, which fulfil the conditions set out in Section 4.6.2.3.2 of Commission Implementing Decision 2012/119/EU. They are summarised in Table 7.2 below.

Table 7.2: Split views expressed

BAT conclusion/Table number	Split view	Expressed by	Alternative proposed level (if any)
BAT 14/Table 5.1	To include slaughterhouses in footnote (4).	AVEC (supported by FR, CLITRAVI and UECBV)	120 mg/l
BAT 14/Table 5.1 and Table 5.2	To delete the BAT-AELs for direct and indirect Cu and Zn emissions to water.	DE, AVEC, CEFIC, CLITRAVI, EFFOP, EFPPRA and UECBV	NA
BAT 15/Table 5.3	To amend footnote (2) to Table 5.3 (for NO _x) as follows: '(2) The upper end of the BAT-AEL range may be higher and up to 400 mg/Nm ³ for recuperative thermal oxidisers'.	FR and EFPPRA	400 mg/Nm ³
BAT 15/Table 5.3	To delete footnote (2) in Table 5.3.	AT	NA
BAT 15/Table 5.3	To increase the upper end of the BAT-AEL range for SO _x emissions to 290 mg/Nm ³ for recuperative thermal oxidisers.	FR and EFPPRA	290 mg/Nm ³
BAT 15/Table 5.3	To add a footnote for SO _x as follows: 'The BAT-AEL range only applies when using exclusively natural gas as a fuel'.	EFPPRA (supported by EFFOP and UECBV)	NA
BAT 15/Table 5.4	To replace 'indicative emission level' with 'BAT-AEL' in Table 5.4 for CO emissions.	EEB	NA
BAT 21/Table 5.5	To replace the 'BAT-AEPLs' with 'indicative environmental performance levels' in Table 5.5 for specific net energy consumption.	UECBV (for cattle, supported by AVEC and CLITRAVI) CLITRAVI (for pigs, supported by AVEC and UECBV) AVEC (for chickens, supported by CLITRAVI and UECBV)	NA
BAT 22/Table 5.6	To replace the 'BAT-AEPLs' with 'indicative environmental performance levels' in Table 5.6 for specific waste water discharge.	UECBV (for cattle, supported by AVEC and CLITRAVI) CLITRAVI (for pigs, supported by AVEC and UECBV) AVEC (for chickens, supported by CLITRAVI and UECBV)	NA
BAT 23/Table 5.7	To replace the 'indicative emission level' with 'BAT-AEL' in Table 5.7 for refrigerant losses.	EEB	NA

BAT conclusion/Table number	Split view	Expressed by	Alternative proposed level (if any)
BAT 24/Table 5.8	To replace the 'BAT-AEPLs' with 'indicative environmental performance levels' in Table 5.8 for specific net energy consumption.	EFPRA and UECBV (for rendering, fat melting, blood and/or feather processing)	NA
		EFFOP (for fishmeal and fish oil production)	
		CEFIC (for gelatine manufacturing)	
Table 5.9	To replace the 'BAT-AEPLs' with 'indicative environmental performance levels' in Table 5.9 for specific waste water discharge.	EFPRA (supported by CEFIC and EFFOP) (for rendering, fat melting, blood and/or feather processing)	NA
		CEFIC (for gelatine manufacturing)	
BAT 25/Table 5.10	To increase the upper end of the BAT-AEL range for TVOC emissions to 20 mg/Nm ³ .	FR and EFPRA	20 mg/Nm ³

Consultation of the Forum and subsequent formal adoption procedure of the BAT Conclusions

In accordance with Article 13(3) of the Directive 2010/75/EU, the Forum delivered its opinion on the final draft of the Best Available Techniques (BAT) Reference Document for Slaughterhouses, Animal By-products and/or Edible co-products Industries (SA BREF) in its meeting of 22 May 2023.

1. The Forum welcomed the draft SA BREF as presented by the Commission.
2. The Forum acknowledged the discussions held at its meeting of 22 May 2023 and agreed that the changes to the draft of the SA BREF, as proposed in Annex A of the publicly available Forum opinion, should be included in the final document.
3. The Forum reaffirmed the comments in Annex B of the publicly available Forum opinion as representing the views of certain members of the Forum but on which no consensus existed within the Forum to include them in the final document.

Subsequently, the Commission took the opinion of the IED Article 13 Forum into account when preparing the draft Commission Implementing Decision establishing Best Available Techniques (BAT) conclusions for Slaughterhouses, Animal By-products and/or Edible co-products Industries. The IED Article 75 Committee, through a written procedure lasting until 2 October 2023, voted in favour of this draft Commission Implementing Decision.

Subsequently, the Commission Implementing Decision (EU) establishing Best Available Techniques (BAT) conclusions for Slaughterhouses, Animal By-products and/or Edible co-products Industries was adopted on 11 December 2023 and published in the Official Journal of the European Union (OJ L, 2023/2749, 18.12.2023, ELI: http://data.europa.eu/eli/dec_impl/2023/2749/oj and corrigendum OJ L, 2024/90008, 12.01.2024, ELI: http://data.europa.eu/eli/dec_impl/2023/2749/corrigendum/2024-01-12/oj).

Recommendations for future work

The information exchange revealed a number of issues that should be addressed during the next review of the SA BREF. The recommendations for the next review include the following:

General

- Collect more information in relation to other than normal operating conditions (OTNOC) occurring in the SA sector.

Emissions to water

- Collect more information, in relation to indirect discharges, on emissions of:
 - COD/TOC;
 - Total N.
- Collect more information on COD/TOC and TSS abatement efficiencies.
- Collect more information on TSS emissions to water for gelatine manufacturing.
- Collect more information on the sources of chloride emissions in waste water (e.g. due to the use of FeCl₃ for phosphorus emissions abatement).
- Reassess whether or not Cu and Zn are to be considered as KEIs for emissions to water from slaughterhouses (the TWG was divided on this issue).
- Collect more information on the sources of Cu and Zn emissions in waste water from slaughterhouses (e.g. the Cu/Zn content in the incoming water).

Emissions to air

- Collect more information on the use of adsorption and absorption techniques.
- Collect more information on the fuel types used in thermal oxidisers.
- For odour emissions, collect more information on the abatement efficiency of the techniques applied as well as on the monitoring standard used covering the different methodologies, in particular in relation to process odour emissions.
- Collect more information on:
 - the influence of VOC emissions (e.g. terpene) generation from the organic material of the biofilter;
 - the methane content in waste gases from the biofilter.
- Collect more information on the correlation between emissions of odour and H₂S.
- Collect more information on the correlation between emissions of odour and NH₃.
- Collect more information on the NH₃ abatement efficiency of the techniques applied and the correlation between nitrogen emissions to air and to water.
- Collect more information on the influence of the use of fuel oil on VOC emissions.
- Collect more information on the NH₃ emissions from fishmeal and fish oil installations.
- Collect more information on odour emissions from gelatine manufacturing.

Specific waste water discharge

- Give further consideration to the possibility to derive BAT-AEPLs for specific water consumption.
- Give further consideration to the possible effect on specific water consumption of product change in gelatine manufacturing.

8 ANNEX I: SA DATA COLLECTION

8.1 The data collection process

The SA data collection process followed the decisions taken at the kick-off meeting for the review of the SA BREF and consisted of the following steps:

- starting from 28 January 2020, the questionnaire template was distributed to the installations taking part in the data collection;
- the installations filled in the questionnaire;
- the Member States' representatives checked the quality and the completeness of the filled-in questionnaires;
- until 30 June 2020, TWG members posted the filled-in questionnaires on BATIS;
- several data updates were provided by Member States' representatives during the SA BREF review.

Data from the filled-in questionnaires were extracted using an Excel macro and compiled into a general data file. The general data file was loaded onto Qlik Sense to create different data visualisation sets. Additional data cleaning operations were implemented to render the format of the data reported adequate.

8.2 Distribution of SA installations

A total of 206 filled-in questionnaires were submitted, by installations located in 14 Member States (MS) and 1 EEA country. The distribution of SA installations by country is shown in Figure 8.1.

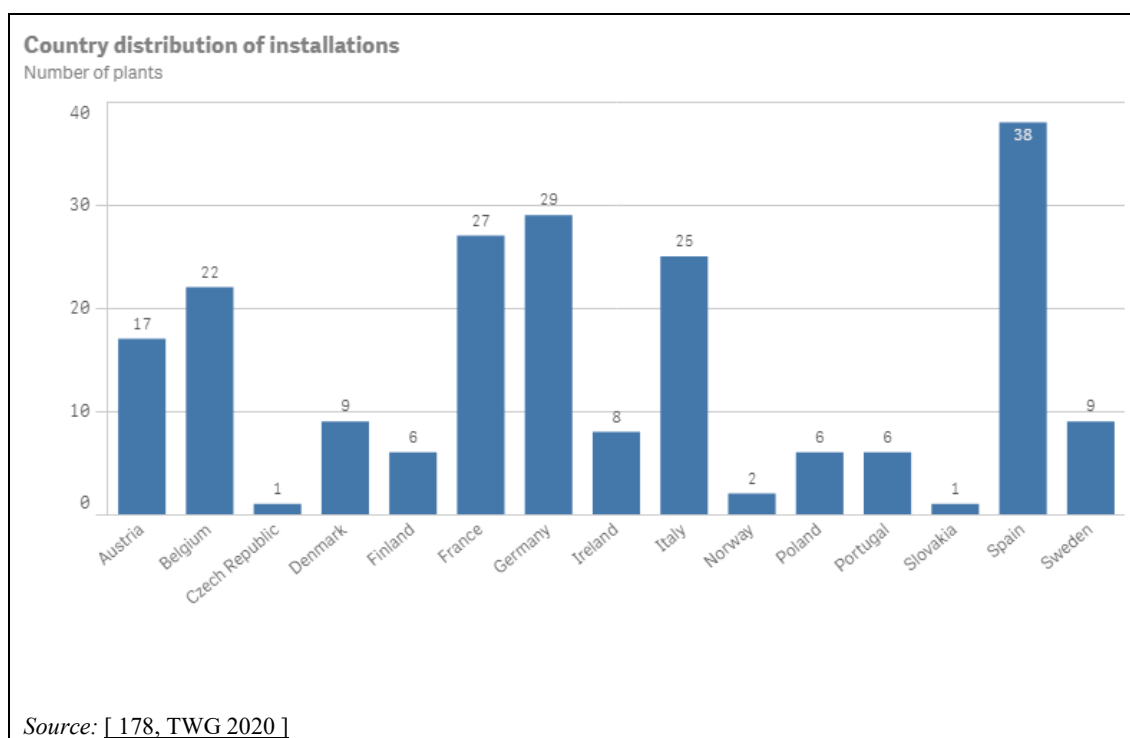

Figure 8.1: Country distribution of the participating SA installations

Figure 8.2 shows the number of SA installations by type of IED activities carried out.

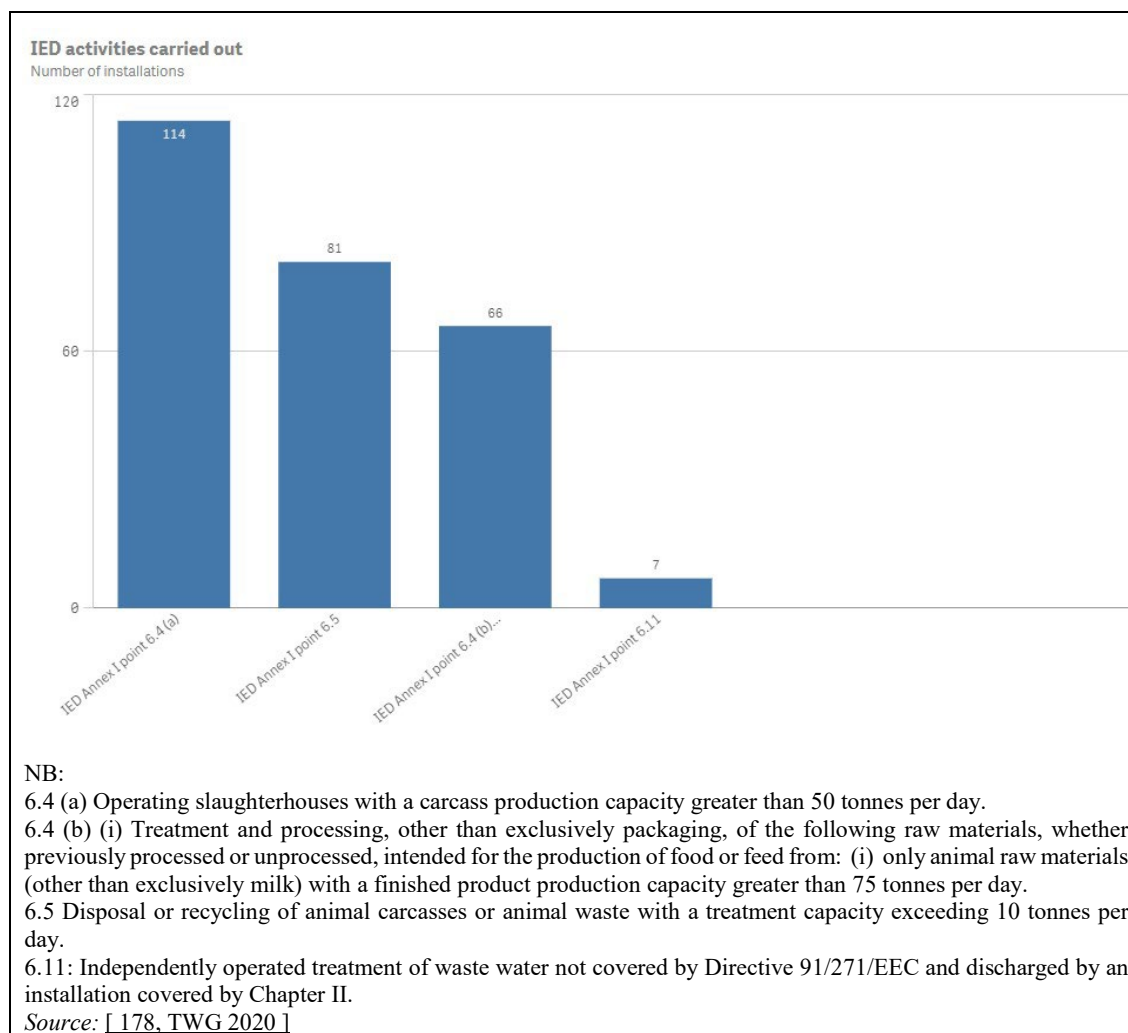

Figure 8.2: Number of SA installations by type of IED activities carried out

The processes carried out at the participating installations are shown in Figure 8.3. The types of activities processing animal by-products and/or edible co-products are shown in Figure 8.4.

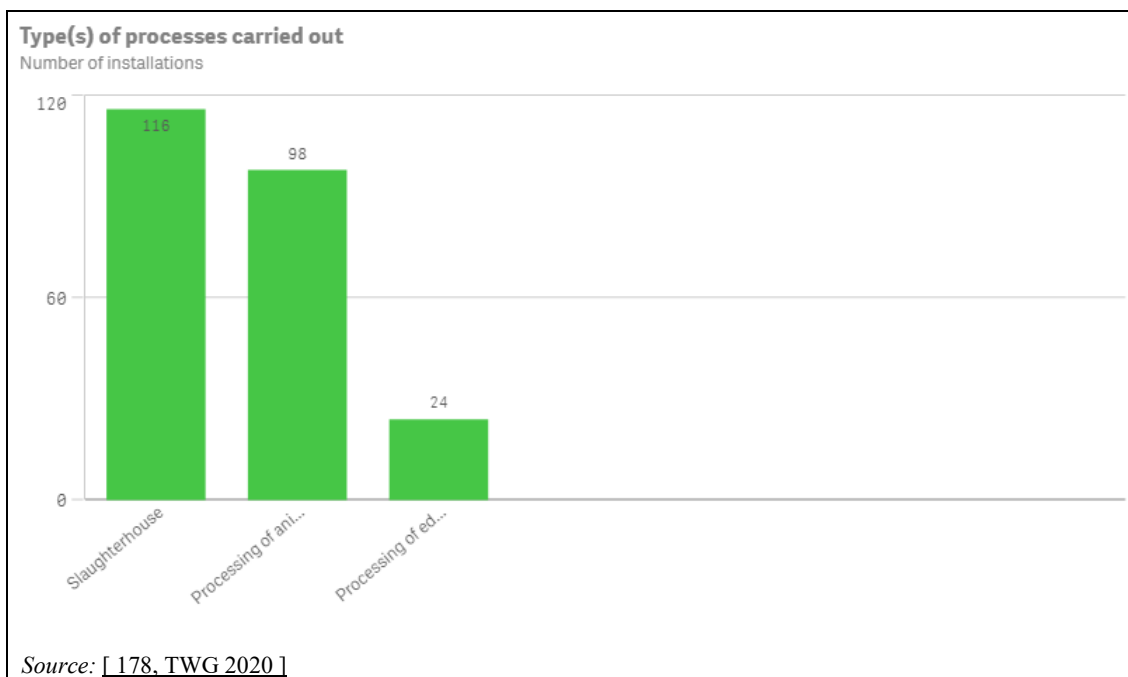

Figure 8.3: Different types of processes

Out of 116 slaughterhouses, 34 also perform activities processing animal by-products and/or edible co-products.

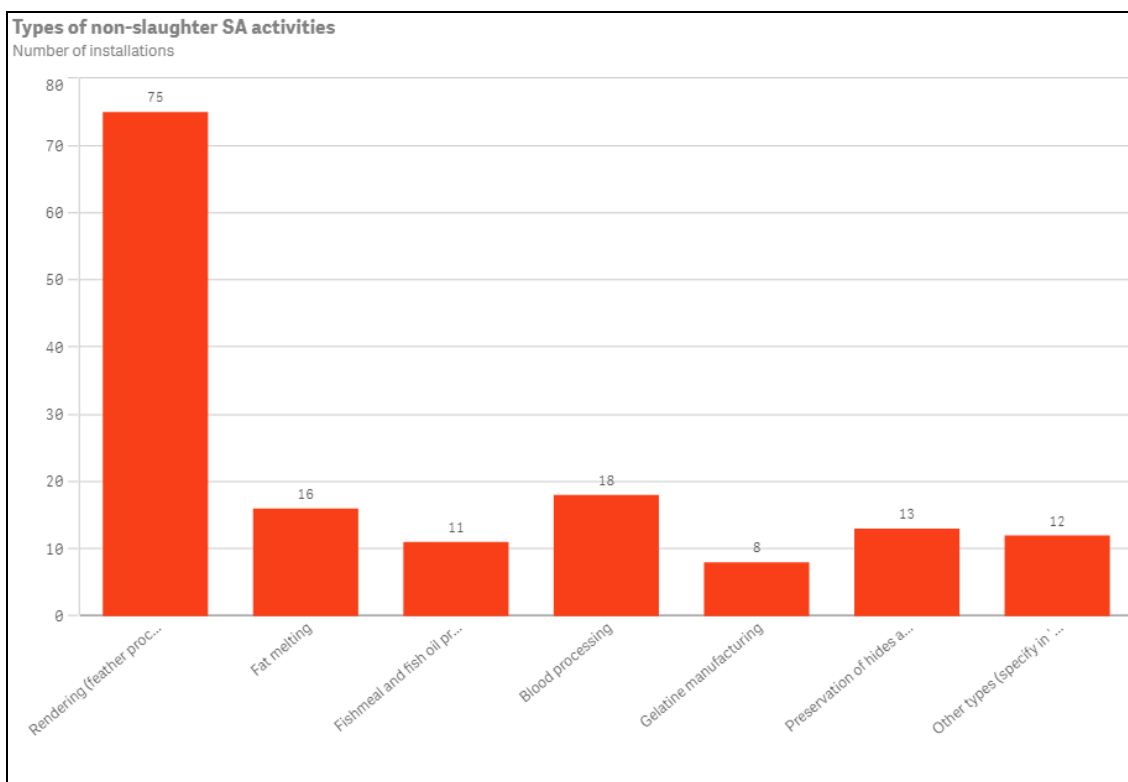

Figure 8.4: Distribution by type of activities processing animal by-products and/or edible co-products

8.3 List of installations that participated in the SA data collection

Country	Code	Installation / Site name	Town	Main sector	Type(s) of slaughtered animals (in the case of a slaughterhouse)	Type of animal by-product and/or edible co-product processing installation	Raw materials (for installations processing animal by-products and/or edible co-products)
AT	AT001	Titz Geflügelschlachthof GmbH	Rohr an der Raab	Slaughterhouse	Chickens		
AT	AT002	Norbert Marcher GmbH - Graz	Graz	Slaughterhouse + Installation processing animal by-products and/or edible co-products	Pigs; cattle	Fat melting	
AT	AT003	Fleischhof Raabtal GmbH	Kirchberg an der Raab	Slaughterhouse	Pigs		
AT	AT004	Steirerfleisch GmbH	Wolfsberg	Slaughterhouse	Pigs		
AT	AT005	Scheucher Fleisch GmbH	Jagerberg	Slaughterhouse	Pigs; cattle		
AT	AT006	Higelsberger GmbH	Schwertberg	Slaughterhouse	Pigs		
AT	AT007	Hubers Landhendl GmbH	Pfaffstätten	Slaughterhouse	Chickens		

Country	Code	Installation / Site name	Town	Main sector	Type(s) of slaughtered animals (in the case of a slaughterhouse)	Type of animal by-product and/or edible co-product processing installation	Raw materials (for installations processing animal by-products and/or edible co-products)
AT	AT008	Alpenrind GmbH	Salzburg	Slaughterhouse	Cattle		
AT	AT009	Rudolf Großfurtner GmbH - Utzenaich	Utzenaich	Slaughterhouse	Cattle		
AT	AT010	Rudolf Großfurtner GmbH - St.Martin	St.Martin	Slaughterhouse	Pigs		
AT	AT011	Herbert Handlbauer GmbH	Linz	Slaughterhouse	Cattle		
AT	AT012	IBOSCHWEIN Vertriebs GmbH	Ried im Traunkreis	Slaughterhouse	Pigs		
AT	AT013	SARIA Bio-Industries GmbH	Tulln	Installation processing animal by-products and/or edible co-products		Rendering, blood processing	Cat. 1, Cat. 3 (blood meal production)
AT	AT014	TKV Oberösterreich GmbH	Regau	Installation processing animal by-products and/or edible co-products		Rendering, blood processing	Cat. 3
AT	AT015	Burgenländische Tierkörperverwertungs GmbH	Unterfrauenhaid	Installation processing animal by-products and/or edible co-products		Rendering	Cat. 1

Country	Code	Installation / Site name	Town	Main sector	Type(s) of slaughtered animals (in the case of a slaughterhouse)	Type of animal by-product and/or edible co-product processing installation	Raw materials (for installations processing animal by-products and/or edible co-products)
AT	AT016	Steirische Tierkörperverwertungsgesellschaft m.b.H & CoKG	Gabersdorf	Installation processing animal by-products and/or edible co-products		Rendering, blood processing	Cat. 3, Cat. 3 (blood meal and plasma production)
AT	AT017	Boxmark Leather GmbH & Co KG	Jennersdorf	Installation processing animal by-products and/or edible co-products		Fat melting	
BE	BE018	Slachthuis Geel (group Sopraco)	Geel	Slaughterhouse	Pigs, cattle		
BE	BE019	Comeco (Common Market Meat Company)	Hoogstraten	Slaughterhouse	Pigs		
BE	BE020	Klaasen & co	Ravels	Slaughterhouse + Installation processing animal by-products and/or edible co-products	Poultry	Rendering, fat melting	Cat. 2, Cat. 3
BE	BE022	Slachthuis Vanlommel	Olen	Slaughterhouse	Cattle		
BE	BE023	Oleki	Olen	Installation processing animal by-products and/or edible co-products		Rendering	Cat. 3, Cat. 3 (feather/pig bristles processing)

Country	Code	Installation / Site name	Town	Main sector	Type(s) of slaughtered animals (in the case of a slaughterhouse)	Type of animal by-product and/or edible co-product processing installation	Raw materials (for installations processing animal by-products and/or edible co-products)
BE	BE024	Wilki	Ravels	Slaughterhouse	Poultry		
BE	BE025	Cominbel	Sint-Lievens-Houtem	Installation processing animal by-products and/or edible co-products		Rendering	Cat. 3
BE	BE026	Porc Meat Zele	Zele	Slaughterhouse	Pigs		
BE	BE027	Rendac (installation 934 & 1660)	Denderleeuw	Installation processing animal by-products and/or edible co-products		Rendering	Cat. 1, Cat. 3
BE	BE029	Exportslachthuis Tielt/Debra-Freeze/Debrameat	Tielt	Slaughterhouse	Pigs		
BE	BE030	Exportslachthuis De Coster	Ruiselede	Slaughterhouse	Pigs		
BE	BE031	Fapro	Ichtegem	Installation processing animal by-products and/or edible co-products		Rendering	Cat. 3
BE	BE032	Sonac Gent	Gent	Installation processing animal by-products and/or edible co-products		Rendering, preservation of hides and skins	Cat. 3

Country	Code	Installation / Site name	Town	Main sector	Type(s) of slaughtered animals (in the case of a slaughterhouse)	Type of animal by-product and/or edible co-product processing installation	Raw materials (for installations processing animal by-products and/or edible co-products)
BE	BE033	Van-O-Bel	Waregem	Slaughterhouse	Poultry		
BE	BE034	Progra	Hulshout	Installation processing animal by-products and/or edible co-products		Rendering	Cat. 3
BE	BE035	Gerard Van Landschoot & Zonen	Maldegem	Slaughterhouse	Pigs		
BE	BE036	M. Ryckaert	Eeklo	Slaughterhouse	Cattle and pigs		
BE	BE038	Rousselot	Gent	Installation processing animal by-products and/or edible co-products		Gelatine manufacturing	Pig skins
BE	BE039	PB Leiner (Tessenderloo Group)	Vilvoorde	Installation processing animal by-products and/or edible co-products		Gelatine manufacturing	
BE	BE040	WZI Olen	Olen			Other (specify in comments column)	

Country	Code	Installation / Site name	Town	Main sector	Type(s) of slaughtered animals (in the case of a slaughterhouse)	Type of animal by-product and/or edible co-product processing installation	Raw materials (for installations processing animal by-products and/or edible co-products)
BE	BE044	Lovenfosse sa	Aubel	Slaughterhouse	Pigs		
BE	BE045	Plukon Mouscron sa	Mouscron	Slaughterhouse	Chickens		
DE	DE047	Emsland Frischgeflügel GmbH	Haren	Slaughterhouse	Chickens		
DE	DE048	Celler Land Frischgeflügel GmbH & Co KG	Wietze	Slaughterhouse	Chickens		
DE	DE049	Tönnies Unternehmensgruppe	Rheda-Wiedenbrück	Slaughterhouse	Pigs		
DE	DE050	Tönnies Unternehmensgruppe	Wilhelmshaven	Slaughterhouse	Cattle		
DE	DE051	Danish Crown Fleisch GmbH	Essen (oldenburg)	Slaughterhouse	Pigs		

Country	Code	Installation / Site name	Town	Main sector	Type(s) of slaughtered animals (in the case of a slaughterhouse)	Type of animal by-product and/or edible co-product processing installation	Raw materials (for installations processing animal by-products and/or edible co-products)
DE	DE057	Vion Food Gruppe	Bad Bramstedt	Slaughterhouse	Cattle		
DE	DE058	Vion Food Gruppe	Perleberg	Slaughterhouse	Pigs		
DE	DE059	Müller Fleisch GmbH	Birkenfeld	Slaughterhouse	Cattle		
DE	DE061	Westfleisch SCE mbH	Bakum (Oldenburg)	Slaughterhouse	Cattle		
DE	DE062	Westfleisch SCE mbH	Lübbecke	Slaughterhouse	Cattle		
DE	DE063	Westfleisch SCE mbH	Gelsenkirchen	Slaughterhouse	Pigs		
DE	DE064	Westfleisch SCE mbH	Coesfeld	Slaughterhouse	Pigs		
DE	DE065	Oldenburger Fleischmehlfabrik GmbH	Friesoythe-Kampe	Installation processing animal by-products and/or edible co-products		Rendering, blood processing, preservation of hides and skins	Cat. 1 and Cat. 3, Cat. 3 (blood meal production)
DE	DE066	Gustav Denzin GmbH	Viersen	Installation processing animal by-products and/or edible co-products		Rendering	Cat. 1

Country	Code	Installation / Site name	Town	Main sector	Type(s) of slaughtered animals (in the case of a slaughterhouse)	Type of animal by-product and/or edible co-product processing installation	Raw materials (for installations processing animal by-products and/or edible co-products)
DE	DE067	Sonac Mering GmbH	Mering	Installation processing animal by-products and/or edible co-products		Rendering, blood processing	Cat. 3, Cat 3 (feather/pig bristles processing)
DE	DE068	Sonac Brünen GmbH	Hamminkeln	Installation processing animal by-products and/or edible co-products		Blood processing	Cat. 3
DE	DE069	ZTS Plattling	Plattling	Installation processing animal by-products and/or edible co-products		Rendering, blood processing	Cat. 1 and Cat. 3, Cat. 3 (blood meal production)
DE	DE071	Bioceval GmbH & Co. KG	Cuxhaven	Installation processing animal by-products and/or edible co-products		Fishmeal and fish oil production	Fish
DE	DE072	Berndt GmbH	Oberding	Installation processing animal by-products and/or edible co-products		Rendering	Cat. 3
DE	DE073	Berndt GmbH	Waldkraiburg	Installation processing animal by-products and/or edible co-products		Rendering, preservation of hides and skins	Cat. 1
DE	DE074	TBA Kraftisried GmbH	Kraftisried	Installation processing animal by-products and/or edible co-products		Rendering, preservation of hides and skins	Cat. 1

Country	Code	Installation / Site name	Town	Main sector	Type(s) of slaughtered animals (in the case of a slaughterhouse)	Type of animal by-product and/or edible co-product processing installation	Raw materials (for installations processing animal by-products and/or edible co-products)
DE	DE075	SecAnim Südwest GmbH	Lampertheim	Installation processing animal by-products and/or edible co-products		Rendering	Cat. 1
DE	DE076	Ten Kate GmbH	Sögel	Installation processing animal by-products and/or edible co-products		Fat melting	Cat. 3
DE	DE077	Zweckverband Tierkörperbeseitigung Nordbayern	Bamberg	Installation processing animal by-products and/or edible co-products		Rendering, preservation of hides and skins	Cat. 1
DE	DE078	VTN Gunzenhausen	Gunzenhausen	Installation processing animal by-products and/or edible co-products		Rendering	Cat. 1
DE	DE079	Sonac Versmold GmbH	Versmold	Installation processing animal by-products and/or edible co-products		Fat melting	Food-grade fat
DE	DE080	Gelita AG	Memmingen	Installation processing animal by-products and/or edible co-products		Gelatine manufacturing	Bones
DE	DE082	Schlachtzentrum Nordfriesland	Husum	Slaughterhouse	Cattle, sheep and goats		

Country	Code	Installation / Site name	Town	Main sector	Type(s) of slaughtered animals (in the case of a slaughterhouse)	Type of animal by-product and/or edible co-product processing installation	Raw materials (for installations processing animal by-products and/or edible co-products)
DE	DE084	PB Leiner Germany	Nienburg	Installation processing animal by-products and/or edible co-products		Gelatine manufacturing	Bovine hide and pigskin
DK	DK085	Farmfood A/S	Loegstoer	Installation processing animal by-products and/or edible co-products		Rendering, fat melting, blood procesing	Cat. 3, Cat. 3 (feather/pig bristles processing)
DK	DK086	Daka Sarval	Loesning	Installation processing animal by-products and/or edible co-products		Rendering	Cat. 2 and Cat. 3
DK	DK087	Daka SecAnim	Randers	Installation processing animal by-products and/or edible co-products		Rendering, preservation of hides and skins	Cat. 1 and Cat. 2
DK	DK088	Danish Crown Blans	Blans	Slaughterhouse	Pigs		
DK	DK089	Danish Crown Horsens	Horsens	Slaughterhouse	Pigs		
DK	DK090	Danish Crown Holsted	Holsted	Slaughterhouse	Cattle		

Country	Code	Installation / Site name	Town	Main sector	Type(s) of slaughtered animals (in the case of a slaughterhouse)	Type of animal by-product and/or edible co-product processing installation	Raw materials (for installations processing animal by-products and/or edible co-products)
DK	DK091	TripleNine Fish Protein A/S	Thyboroen	Installation processing animal by-products and/or edible co-products		Fishmeal and fish oil production	Fresh fish Offcuts from production of fish products
DK	DK092	FF Skagen	Skagen	Installation processing animal by-products and/or edible co-products		Fishmeal and fish oil production	Fresh fish Offcuts from production of fish products
DK	DK093	HKScan Denmark A/S	Vinderup	Slaughterhouse	Chickens		
ES	ES095	Complejo industrial Mataderos Industriales Soler, S.A. (PROLONGO) y Frigoríficos Andaluces de Conservas de Carne, S.A. (FACCSA)	Andalucía. Cártama (Málaga)	Slaughterhouse	Pigs		
ES	ES097	Sánchez Romero Carvajal Jabugo S.A	Andalucía. Jabugo (Huelva)	Slaughterhouse	Pigs		
ES	ES100	Matadero Fribin - Binéfar	Aragón. Binéfar (Huesca)	Slaughterhouse	Pigs, cattle		

Country	Code	Installation / Site name	Town	Main sector	Type(s) of slaughtered animals (in the case of a slaughterhouse)	Type of animal by-product and/or edible co-product processing installation	Raw materials (for installations processing animal by-products and/or edible co-products)
ES	ES102	Carnes Selectas 2000 S.A.	Castilla y León. Burgos	Slaughterhouse	Pigs		
ES	ES103	Eurocentro de Carnes	Castilla-La Mancha. La Puebla de Montalbán (Toledo)	Slaughterhouse	Pigs		
ES	ES104	Industrias cárnicas Loriente Piqueras (INCARLOPSA)	Castilla-La Mancha. Tarancón (Cuenca)	Slaughterhouse	Pigs		
ES	ES105	FRIMANCHA Industrias cárnicas	Castilla-La Mancha. Valdepeñas (Ciudad Real)	Slaughterhouse	Pigs, cattle	Rendering and fat melting	Cat. 1
ES	ES107	MAFRICA - Matadero frigorífico del Cardoner	Cataluña. Sant Joan de Vilatorrada (Barcelona)	Slaughterhouse + Installation processing animal by-products and/or edible co-products	Pigs, sheep and goats, cattle	Other (specify in comments column)	Cat. 3
ES	ES108	PATEL, SAU	Cataluña. L'Esquirol (Barcelona)	Slaughterhouse	Pigs		

Country	Code	Installation / Site name	Town	Main sector	Type(s) of slaughtered animals (in the case of a slaughterhouse)	Type of animal by-product and/or edible co-product processing installation	Raw materials (for installations processing animal by-products and/or edible co-products)
ES	ES109	Viñals Soler S.L.	Cataluña. Argentona (Barcelona)	Slaughterhouse	Sheep and goats, cattle		
ES	ES110	FRISELVA, SA	Cataluña. Riudellots de la Selva (Girona)	Slaughterhouse + Installation processing animal by-products and/or edible co-products	Pigs	Rendering	Cat. 3
ES	ES111	OLOT MEATS, S.A.	Cataluña. Olot (Gerona)	Slaughterhouse + Installation processing animal by-products and/or edible co-products	Pigs	Other (specify in comments column)	
ES	ES112	EDAR OLOT	Cataluña. Olot (Gerona)				
ES	ES114	Le Porc Gourmet SAU	Cataluña. Santa Eugenia de Berga (Barcelona)	Slaughterhouse + Installation processing animal by-products and/or edible co-products	Pigs	Rendering	Cat. 3
ES	ES115	Matadero de Sabadell	Cataluña. Sabadell	Slaughterhouse + Installation processing animal by-products and/or edible co-products	Sheep and goats, cattle	Other (specify in comments column)	
ES	ES116	Escorxador Frigorific D'Osona	Cataluña. Vic (Barcelona)	Slaughterhouse	Pigs		

Country	Code	Installation / Site name	Town	Main sector	Type(s) of slaughtered animals (in the case of a slaughterhouse)	Type of animal by-product and/or edible co-product processing installation	Raw materials (for installations processing animal by-products and/or edible co-products)
ES	ES117	Elaborados cárnicos Medina S.A.	C. Valenciana. Buñol (Valencia)	Slaughterhouse	Cattle		
ES	ES119	El Pozo Alimentación	Murcia (Región de). Alhama de Murcia (Murcia)	Slaughterhouse + Installation processing animal by-products and/or edible co-products	Pigs	Rendering, fat melting, blood processing	
ES	ES120	PROTECA - Protectora de carnes	Navarra (C. Foral). Pamplona	Slaughterhouse	Sheep and goats, cattle, horse		
ES	ES121	Harinas de Andalucía S.A.	Andalucía. Tarifa (Cádiz)	Installation processing animal by-products and/or edible co-products		Fishmeal and fish oil production	Fish
ES	ES122	SECANIM BIO-INDUSTRIES, S.A.U- (SAN MARTÍN Y MUDRIAN)	Castilla y León. San Martín y San Mudrián (Segovia)	Installation processing animal by-products and/or edible co-products		Rendering	Cat. 1 and Cat. 2
ES	ES123	SARVAL BIO-INDUSTRIES, S.L.U (SAN MARTIN Y MUDRIAN)	Castilla y León. San Martín y San Mudrián (Segovia)	Installation processing animal by-products and/or edible co-products		Rendering	Cat. 3, Cat. 3 (blood processing for production of plasma and red cells), Cat. 3 (feather/pig bistles processing)

Country	Code	Installation / Site name	Town	Main sector	Type(s) of slaughtered animals (in the case of a slaughterhouse)	Type of animal by-product and/or edible co-product processing installation	Raw materials (for installations processing animal by-products and/or edible co-products)
ES	ES124	GRAINTO S.L.	Castilla-La Mancha. Portillo de Toledo (Toledo)	Installation processing animal by-products and/or edible co-products		Rendering	Cat. 3
ES	ES125	SARVAL BIO-INDUSTRIES S.L.U.- ST. ESTEVE (LA VALL D'EN BAS)	Cataluña. La Vall D'en Bas (Gerona)	Installation processing animal by-products and/or edible co-products		Rendering	Cat. 3: Poultry line, Mammals, ruminants & not ruminant. Line Feather-hair)
ES	ES126	SECANIM BIO-INDUSTRIES SAU - TERMENS	Cataluña. Térmens (Lérida)	Installation processing animal by-products and/or edible co-products		Rendering	Cat. 1 and Cat. 2
ES	ES127	SARVAL BIO-INDUSTRIES S.L.U.- BEGUDÁ (SANT JOAN LES FONTS)	Cataluña. Sant Joan les Fonts (Gerona)	Installation processing animal by-products and/or edible co-products		Rendering	Cat. 3 (Poultry line & Pork line)
ES	ES128	APC EUROPE SLU	Cataluña. Granollers (Barcelona)	Installation processing animal by-products and/or edible co-products		Blood processing	Blood from pigs, cattle and chickens
ES	ES129	AVIFOOD S.L.U.	Cataluña. Santa Bàrbara (Tarragona)	Installation processing animal by-products and/or edible co-products		Rendering, blood processing	Cat. 3 (Poultry line; Feather line; Blood line)
ES	ES130	SARVAL BIO-INDUSTRIES S.L.U. - ALMASSORA	C. Valenciana. Almazora (Castellón)	Installation processing animal by-products and/or edible co-products		Rendering	Cat. 3 Line Poultry, Mammals, ruminants & not ruminant

Country	Code	Installation / Site name	Town	Main sector	Type(s) of slaughtered animals (in the case of a slaughterhouse)	Type of animal by-product and/or edible co-product processing installation	Raw materials (for installations processing animal by-products and/or edible co-products)
ES	ES131	SELEV PET INDUSTRY, S.L.	C. Valenciana. Silla (Valencia)	Installation processing animal by-products and/or edible co-products		Rendering	Cat. 3 Line Poultry, Mammals, ruminants & not ruminant
ES	ES132	SARVAL BIO-INDUSTRIES NOROESTE, S.A.U	Galicia. Arteixo (La Coruña)	Installation processing animal by-products and/or edible co-products		Rendering, fishmeal and fish oil production	Cat. 3
ES	ES133	Conserveros reunidos	Galicia. Ribeira (La Coruña)	Installation processing animal by-products and/or edible co-products		Fishmeal and fish oil production	Fish by-products
ES	ES135	SARVAL BIO-INDUSTRIES S.L.U.-(ARGANDA DEL REY)	Madrid (Comunidad de). Arganda del Rey	Installation processing animal by-products and/or edible co-products		Rendering	Cat. 3
ES	ES136	SARVAL BIO-INDUSTRIES S.L.U. - HUMANES DE MADRID	Madrid (Comunidad de). Humanes de Madrid	Installation processing animal by-products and/or edible co-products		Rendering	Cat.3 Pork line
ES	ES137	COPRESA - Comercial de Productos Recuperados S.A.	Murcia (Región de). Lorca	Installation processing animal by-products and/or edible co-products		Rendering	
ES	ES139	GESUGA	Galicia. Cerceda (A Coruña)	Installation processing animal by-products and/or edible co-products		Rendering, preservation of hides and skins	Cat. 1, Cat. 2

Country	Code	Installation / Site name	Town	Main sector	Type(s) of slaughtered animals (in the case of a slaughterhouse)	Type of animal by-product and/or edible co-product processing installation	Raw materials (for installations processing animal by-products and/or edible co-products)
ES	ES140	SAMI - Leridana de piensos	Cataluña. Vallfogona de Balaguer (Lérida)	Slaughterhouse	Pigs		
ES	ES141	Frigorífics Costa Brava	Cataluña. Riudellots de la Selva (Gerona)	Installation processing animal by-products and/or edible co-products	Pigs	Rendering	Cat. 3
FI	FI142	Oravainen destruction plant	Oravainen	Installation processing animal by-products and/or edible co-products		Rendering	Fox and mink carcasses and whole chickens
FI	FI143	Honkajoki	Honkajoki	Installation processing animal by-products and/or edible co-products		Rendering, fat melting	Cat. 1, Cat. 2 and Cat. 3
FI	FI144	Nurmo factory	Seinäjoki	Slaughterhouse	Pigs, chickens		
FI	FI145	Forssa factory	Forssa	Slaughterhouse	Pigs		

Country	Code	Installation / Site name	Town	Main sector	Type(s) of slaughtered animals (in the case of a slaughterhouse)	Type of animal by-product and/or edible co-product processing installation	Raw materials (for installations processing animal by-products and/or edible co-products)
FI	FI146	Pietarsaari factory	Pietarsaari	Slaughterhouse	Pigs, cattle		
FI	FI147	Säkylä factory	Säkylä	Slaughterhouse	Turkeys, chickens		
IE	IE149	Pelagia Feed Ltd. (P0416-04)	Killybegs, Donegal	Installation processing animal by-products and/or edible co-products	Fish	Fishmeal and fish oil production	Fishmeal and Fish oil
IE	IE150	ABP Cahir (P0039-02)	Cahir Co Tipperary	Slaughterhouse	Beef	Other (specify in comments column)	
IE	IE151	ICM Camolin (P0177-03)	Camolin Co Wexford	Slaughterhouse	Sheep and goats	Other (specify in comments column)	
IE	IE152	ABP Bandon (P0188-02)	Bandon Co Cork	Slaughterhouse	Cattle	Other (specify in comments column)	

Country	Code	Installation / Site name	Town	Main sector	Type(s) of slaughtered animals (in the case of a slaughterhouse)	Type of animal by-product and/or edible co-product processing installation	Raw materials (for installations processing animal by-products and/or edible co-products)
IE	IE153	Kepak Athleague (P0168-01)	Athleague	Slaughterhouse	Cattle, sheep and goats		
IE	IE154	Donegal Meat Processors (P0187-03)	Carrigans, Donegal	Slaughterhouse	Cattle		
IE	IE156	Dawn Meats Ireland Unlimited Company (P0173-02)	Charleville	Slaughterhouse	Cattle		
IE	IE157	Dawn Pork and Bacon (P1075-02)	Grannagh	Slaughterhouse	Pigs	Other (specify in comments column)	
IT	IT158	AGRICOLA TRE VALLI	San Martino Buon Albergo (VR)	Slaughterhouse + Installation processing animal by-products and/or edible co-products	Chickens, turkeys	Rendering	Processing lines for meat, feathers
IT	IT159	AGRICOLA TRE VALLI	Verona (VR)	Installation processing animal by-products and/or edible co-products		Rendering	Eggshell

Country	Code	Installation / Site name	Town	Main sector	Type(s) of slaughtered animals (in the case of a slaughterhouse)	Type of animal by-product and/or edible co-product processing installation	Raw materials (for installations processing animal by-products and/or edible co-products)
IT	IT160	AGRICOLA TRE VALLI	Castegnero (VI)	Slaughterhouse + Installation processing animal by-products and/or edible co-products	Chickens	Rendering	
IT	IT161	SALGAIM	Campagna Lupia (VE)	Installation processing animal by-products and/or edible co-products		Rendering	Cat. 3
IT	IT162	SALGAIM	Tezze sul Brenta (VI)	Installation processing animal by-products and/or edible co-products		Rendering	Cat. 3, Cat. 3 (feather processing)
IT	IT163	GRENA	San Bonifacio (VR)	Installation processing animal by-products and/or edible co-products		Rendering	Cat. 2
IT	IT164	ECB	Sorgà (VR)	Installation processing animal by-products and/or edible co-products		Rendering, blood processing	Cat. 3 (blood meal production), Cat. 3 (feathers/pig bristles processing)
IT	IT165	AL VENTO	Verona (VR)	Installation processing animal by-products and/or edible co-products		Rendering	Cat. 3

Country	Code	Installation / Site name	Town	Main sector	Type(s) of slaughtered animals (in the case of a slaughterhouse)	Type of animal by-product and/or edible co-product processing installation	Raw materials (for installations processing animal by-products and/or edible co-products)
IT	IT166	KEMIN NUTRISURANCE	Veronella (VR)	Installation processing animal by-products and/or edible co-products		Rendering	Fresh/frozen chicken and pork liver
IT	IT167	SOLAR	Padova (PD)	Installation processing animal by-products and/or edible co-products		Rendering	Cat. 2 and Cat. 3
IT	IT168	SAPI S.p.A.	Castelnuovo Rangone (MO)	Installation processing animal by-products and/or edible co-products		Rendering, preservation of hides and skins	Cat. 3
IT	IT169	SAPI S.p.A.	San Martino in Rio (RE)	Installation processing animal by-products and/or edible co-products		Rendering	Cat. 2
IT	IT170	Dusty Rendering srl	Polesine Zibello (PR)	Installation processing animal by-products and/or edible co-products		Rendering	Cat. 1
IT	IT171	FARM SERVICE S.R.L.	Reggio nell'Emilia (RE)	Installation processing animal by-products and/or edible co-products		Rendering	Cat. 3
IT	IT172	CLAI Soc. Coop. Agricola	Faenza (RA)	Slaughterhouse	Pigs and cattle		
IT	IT173	AVI.COOP	Cesena (FC)	Slaughterhouse + Installation processing animal by-products and/or edible co-products	Poultry	Rendering, fat melting	

Country	Code	Installation / Site name	Town	Main sector	Type(s) of slaughtered animals (in the case of a slaughterhouse)	Type of animal by-product and/or edible co-product processing installation	Raw materials (for installations processing animal by-products and/or edible co-products)
IT	IT174	POLLO DEL CAMPO	Santa Sofia (FC)	Slaughterhouse	Chickens		
IT	IT176	ALBERIO SPA	Cirimido (CO)	Installation processing animal by-products and/or edible co-products		Rendering, blood processing	Cat. 3
IT	IT177	ECO RENDERING SRL	Fenegrò (CO)	Installation processing animal by-products and/or edible co-products		Fat melting	Cat. 1
IT	IT178	Inalca S.p.a.	Ospedaletto Lodigiano (LO)	Slaughterhouse			
SE	SE180	KLS Ugglarps Hörby	Hörby	Slaughterhouse	Cattle, sheep and goats		
SE	SE181	KLS Ugglarps Kalmar	Kalmar	Slaughterhouse	Cattle, pigs, sheep		
SE	SE182	HKScan Sweden AB Kristianstad	Kristianstad	Slaughterhouse	Pigs		

Country	Code	Installation / Site name	Town	Main sector	Type(s) of slaughtered animals (in the case of a slaughterhouse)	Type of animal by-product and/or edible co-product processing installation	Raw materials (for installations processing animal by-products and/or edible co-products)
SE	SE183	HKScan Sweden AB Linköping	Linköping	Slaughterhouse	Cattle, sheep and goats		
SE	SE184	Skövde Slakteri AB	Skövde	Slaughterhouse	Cattle and pigs		
SE	SE185	Dahlbergs slakteri	Brålanda	Slaughterhouse	Cattle, Pigs		
SE	SE186	Gotlands slagteri	Visby	Slaughterhouse + Installation processing animal by-products and/or edible co-products	Cattle, Pigs, Lambs	Rendering	
SE	SE189	Konvex, Mosserud	Karlskoga	Installation processing animal by-products and/or edible co-products		Rendering	
SE	SE190	GELITA Sweden AB	Klippan	Installation processing animal by-products and/or edible co-products		Gelatine manufacturing	Pigskin

Country	Code	Installation / Site name	Town	Main sector	Type(s) of slaughtered animals (in the case of a slaughterhouse)	Type of animal by-product and/or edible co-product processing installation	Raw materials (for installations processing animal by-products and/or edible co-products)
SK	SK192	GeLiMa, a.s	Liptovsky Mikulas	Installation processing animal by-products and/or edible co-products		Gelatine manufacturing	Fish skin
FR	FR228	Rousselot ISS	Isle sur la Sorgue	Installation processing animal by-products and/or edible co-products		Gelatine manufacturing	Bones
FR	FR229	Gelatines Weishardt	Graulhet	Installation processing animal by-products and/or edible co-products		Gelatine manufacturing	Pig skins
FR	FR231	Socopa viandes	Villefranche d'Allier	Slaughterhouse	Cattle		
FR	FR232	Sicarev	Roanne	Slaughterhouse	Cattle		
FR	FR233	LDC Bourgogne	Branges	Slaughterhouse	Chickens		
FR	FR234	KERVALIS Armor	Trémoré	Installation processing animal by-products and/or edible co-products		Rendering	Cat. 3, Cat. 3 (feather/pig bristles processing)
FR	FR235	SECANIM Bretagne	Plouvara	Installation processing animal by-products and/or edible co-products		Rendering	Cat. 1 and Cat. 2

Country	Code	Installation / Site name	Town	Main sector	Type(s) of slaughtered animals (in the case of a slaughterhouse)	Type of animal by-product and/or edible co-product processing installation	Raw materials (for installations processing animal by-products and/or edible co-products)
FR	FR236	KERVALIS	Vitré	Installation processing animal by-products and/or edible co-products		Rendering	Cat. 3
FR	FR237	LDC Keranna	Guisriff	Slaughterhouse + Installation processing animal by-products and/or edible co-products	Poultry	Rendering	Cat. 3
FR	FR238	LDC Celvia	Saint Jean Brévelay	Slaughterhouse	Turkeys		
FR	FR239	Procanar	Lauzarch	Slaughterhouse	Ducks		
FR	FR240	SNV Volabraye	Savigny-sur-Braye	Slaughterhouse	Turkeys		
FR	FR241	SOLEVAL France	Charny sur Meuse	Installation processing animal by-products and/or edible co-products		Rendering, fat melting	Cat. 3, Cat. 3 (fat melting)
FR	FR242	Charal Metz	Metz	Slaughterhouse	Cattle, pigs		
FR	FR243	ATEMAX France	Vénérolles	Installation processing animal by-products and/or edible co-products		Rendering, preservation of hides and skins	Cat. 1
FR	FR244	Bigard formerie	Formerie	Slaughterhouse	Cattle		

Country	Code	Installation / Site name	Town	Main sector	Type(s) of slaughtered animals (in the case of a slaughterhouse)	Type of animal by-product and/or edible co-product processing installation	Raw materials (for installations processing animal by-products and/or edible co-products)
FR	FR245	COPALIS	Le Portel	Installation processing animal by-products and/or edible co-products		Fishmeal and fish oil production	
FR	FR246	AEMAX France	Saint Langis les Mortagne	Installation processing animal by-products and/or edible co-products		Rendering, preservation of hides and skins	Cat. 1 and Cat. 2
FR	FR247	LDC Aquitaine	Bazas	Slaughterhouse	Chickens		
FR	FR248	AEMAX France	Le Passage d' Agen	Installation processing animal by-products and/or edible co-products		Rendering, blood processing	Cat. 1, Cat. 2 and Cat. 3
FR	FR249	Somafer	Bessines-sur-Gartempe	Slaughterhouse	Sheep and goats, cattle		
FR	FR250	SOLEVAL France	Auterive	Installation processing animal by-products and/or edible co-products		Rendering	Cat. 3
FR	FR252	Charal Cholet	Cholet	Slaughterhouse	Cattle		
FR	FR253	Socopa	Evron	Slaughterhouse	Pigs		
FR	FR254	Arrive	Essarts-en Bocage	Slaughterhouse	Chickens		

Country	Code	Installation / Site name	Town	Main sector	Type(s) of slaughtered animals (in the case of a slaughterhouse)	Type of animal by-product and/or edible co-product processing installation	Raw materials (for installations processing animal by-products and/or edible co-products)
FR	FR255	Cooperl	Montfort-sur-Meu	Slaughterhouse	Pigs		
FR	FR256	Tendriade	Chateaubourg	Slaughterhouse + Installation processing animal by-products and/or edible co-products	Cattle	Blood processing, preservation of hides and skins	
IT	IT262	Diusa Rendering S.r.l.	Fombio (LO)	Installation processing animal by-products and/or edible co-products		Rendering	Cat. 2
IT	IT263	C.A.R.N.J. SOCIETA' COOPERATIVA AGRICOLA	Cingoli (MC) Località Cerrete Collicelli	Slaughterhouse	Chickens		
IT	IT264	C.A.R.N.J. SOCIETA' COOPERATIVA AGRICOLA	Comune di Castelplanio (AN)	Slaughterhouse	Chickens		
PT	PT265	Lusiaves - Indústria e Comércio Agro-Alimentar, SA	Figueira da Foz	Slaughterhouse	Chickens		
PT	PT269	Carnes Landeiro, S.A	Barcelos	Slaughterhouse	Pigs, cattle		
PT	PT270	Empresa Figueirense de Pesca Lda	Figueira da Foz	Installation processing animal by-products and/or edible co-products		Fishmeal and fish oil production	Cat. 3: Fish by-products
PT	PT271	SAVIBEL, Sociedade Avícola, SA - Centro de Abate de Aves	Oliveira de Frades	Slaughterhouse	Chickens		

Country	Code	Installation / Site name	Town	Main sector	Type(s) of slaughtered animals (in the case of a slaughterhouse)	Type of animal by-product and/or edible co-product processing installation	Raw materials (for installations processing animal by-products and/or edible co-products)
PT	PT272	CRIZAVES - Centro de Abate de Aves, S.A.	Tondela	Slaughterhouse	Chickens, turkeys		
PT	PT275	Luís Leal & Filhos, S. A.	Santa Maria da Feira	Installation processing animal by-products and/or edible co-products		Rendering, fat melting	Cat. 1 and Cat. 3
NO	NO280	TripleNine Vedde AS	Langevåg	Installation processing animal by-products and/or edible co-products		Fishmeal and fish oil production	Fresh fish Offcuts from production of fish products
NO	NO281	Pelagia Karmsund Fiskemel	Karmøy	Installation processing animal by-products and/or edible co-products		Fishmeal and fish oil production	Fresh fish Offcuts from production of fish products
IT	IT282	Stabilimento di San Giorgio in Bosco	San Giorgio in Bosco (PD)	Slaughterhouse	Rabbits		
IT	IT283	Stabilimento di Vazzola	Vazzola (TV)	Slaughterhouse	Chickens		
PL	PL284	Animex Foods Starachowice	Starachowice	Slaughterhouse	Pigs		
PL	PL285	Animex Foods Elk	Elk	Slaughterhouse	Pigs		
PL	PL286	Animex Foods Szczecin	Szczecin	Slaughterhouse	Pigs		
PL	PL287	Animex Foods Opole	Opole	Slaughterhouse	Chickens		

Annexes

Country	Code	Installation / Site name	Town	Main sector	Type(s) of slaughtered animals (in the case of a slaughterhouse)	Type of animal by-product and/or edible co-product processing installation	Raw materials (for installations processing animal by-products and/or edible co-products)
PL	PL288	Goodvalley Food Slaughterhouse	Przechlewo	Slaughterhouse	Pigs		
PL	PL289	Animex Foods Iława	Iława	Slaughterhouse	Turkeys/Geese		
CZ	CZ290	MASO UZENINY POLIČKA	Kamenec u Poličky	Slaughterhouse			

9 ANNEX II: EXAMPLES OF FLOWCHARTS

9.1 Slaughterhouses

Figure 9.1, Figure 9.2 and Figure 9.3 present the flowcharts of some slaughtering processes.

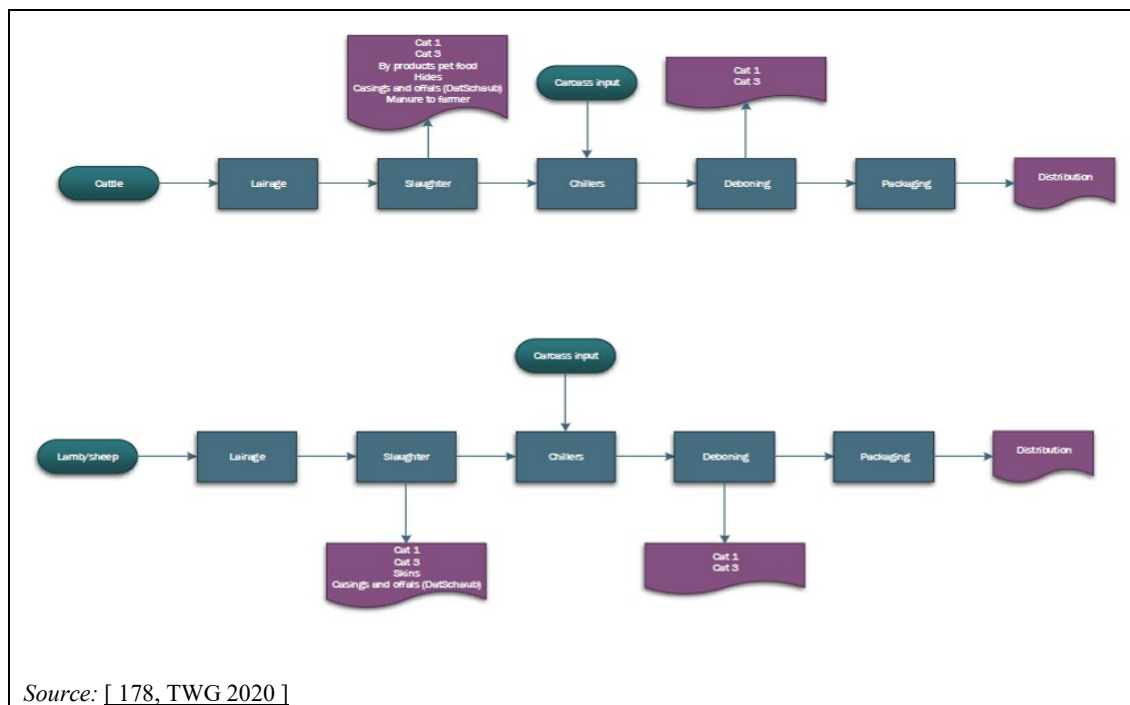
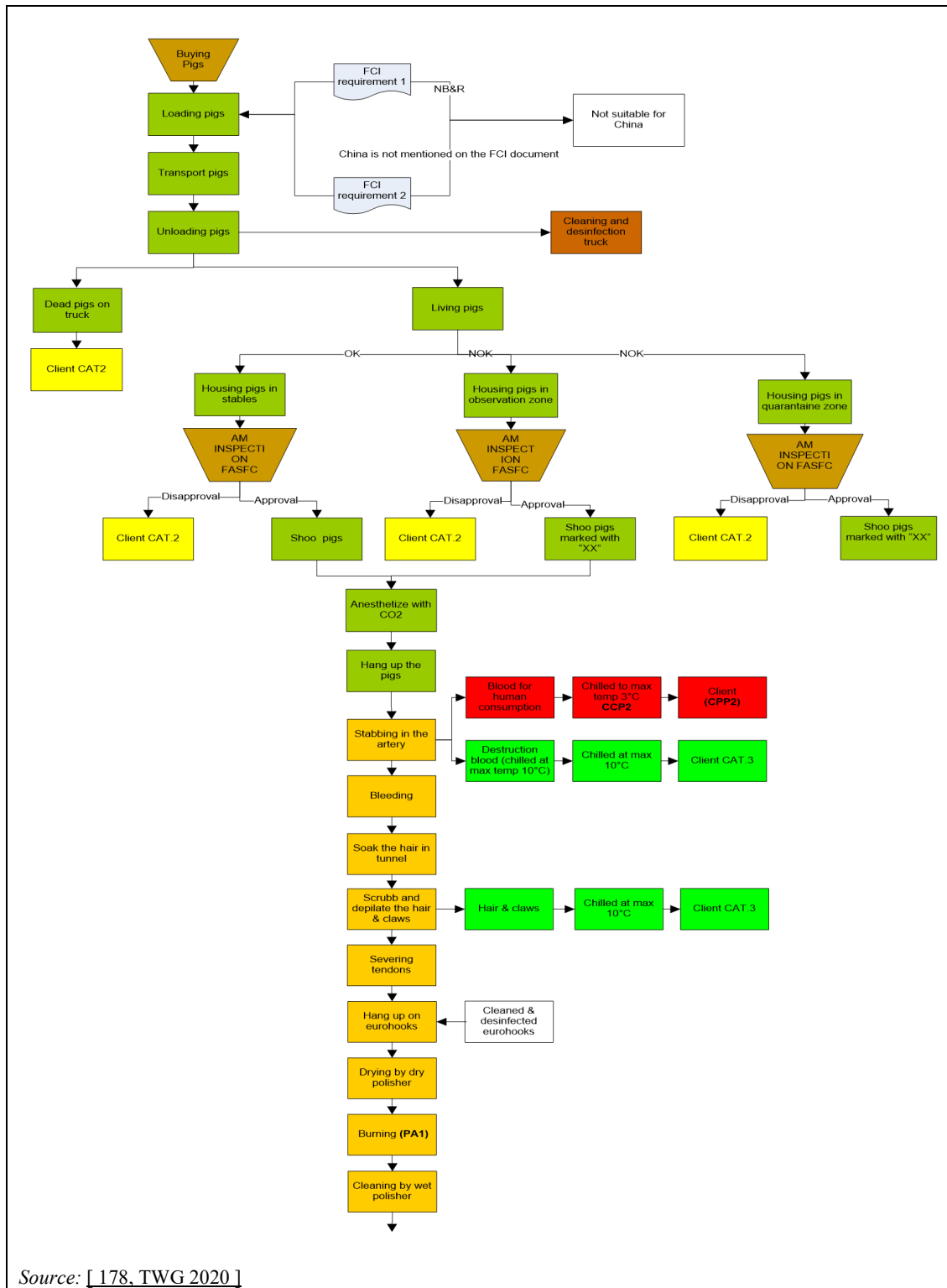
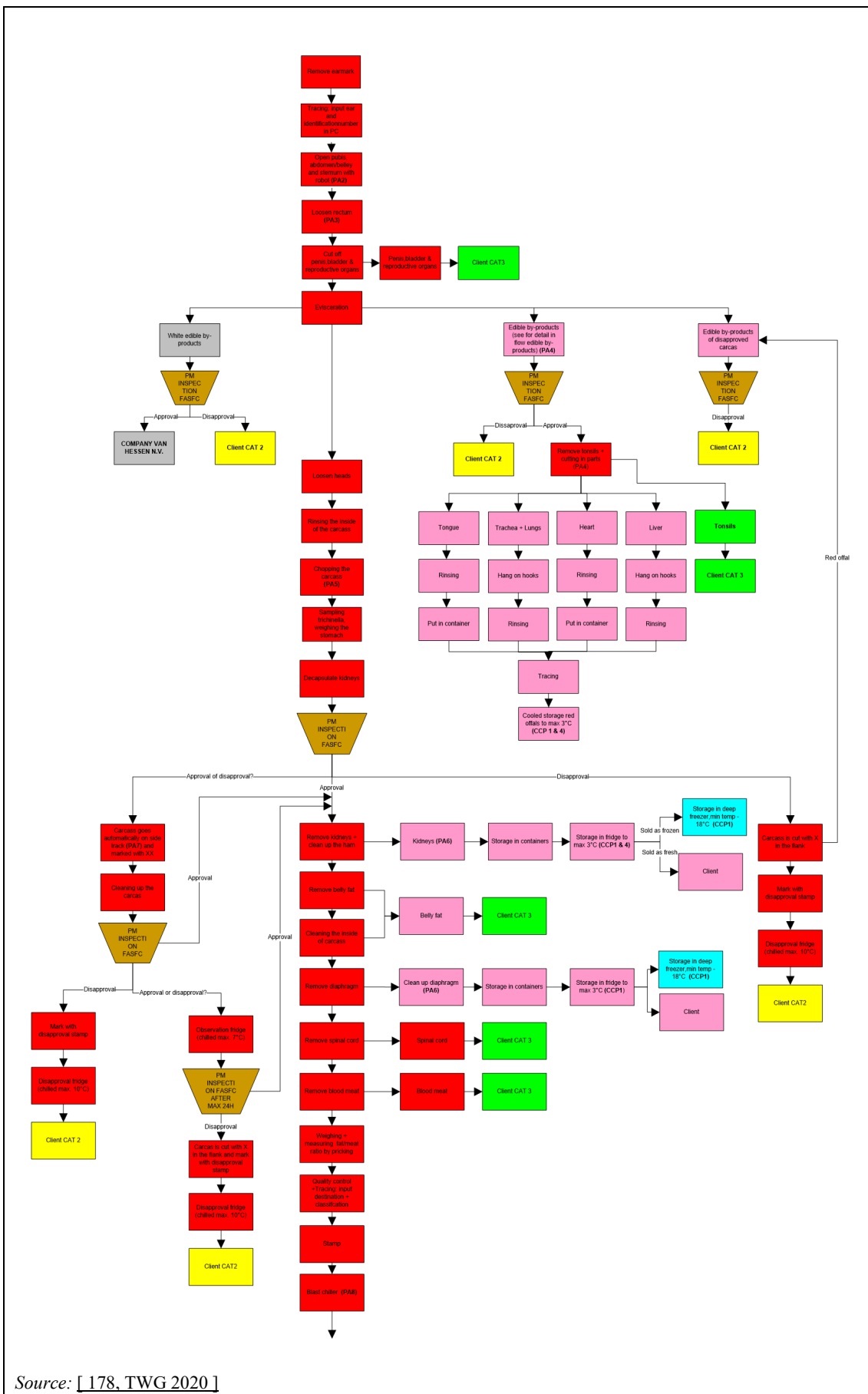

Figure 9.1: Flowchart of a slaughtering process



Source: [178, TWG 2020]

Figure 9.2: Flowchart of a slaughtering process (unclean area)



Source: [178, TWG 2020]

Figure 9.3: Flowchart of a slaughtering process (clean area)

9.2 Processing of animal-by products and/or edible co-products

Figure 9.4, Figure 9.5 and Figure 9.6 present the flowcharts of some rendering processes.

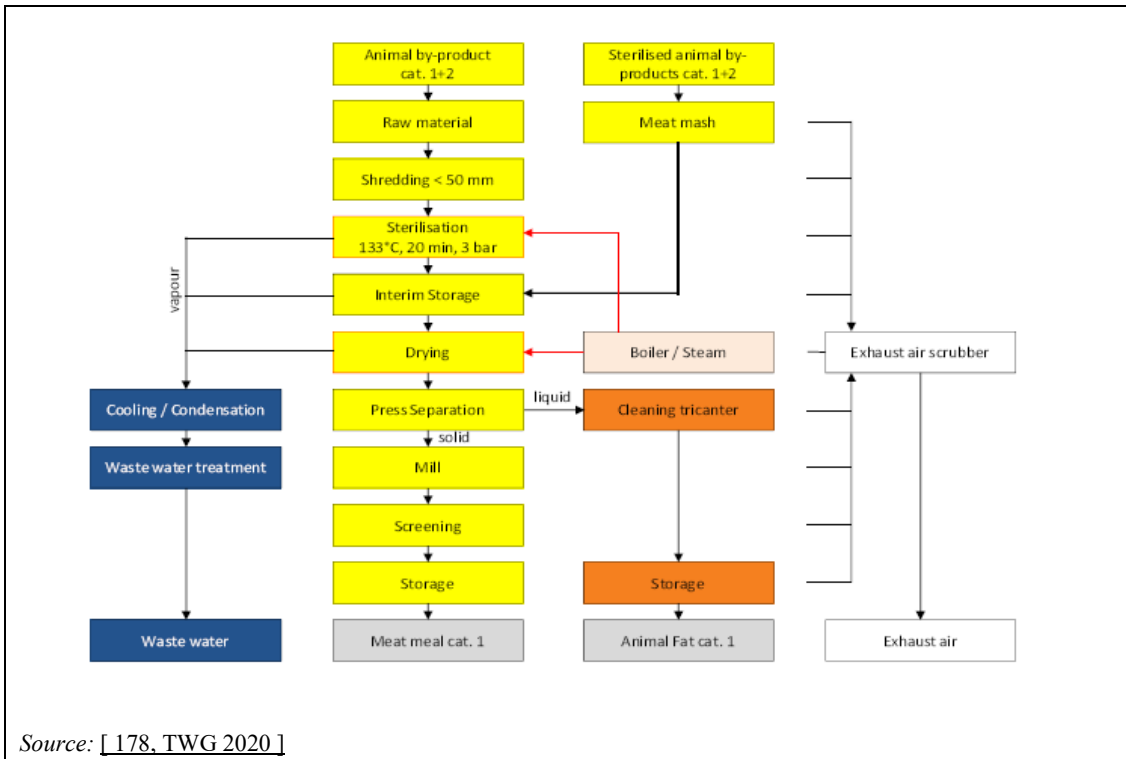

Figure 9.4: Flowchart of a rendering process

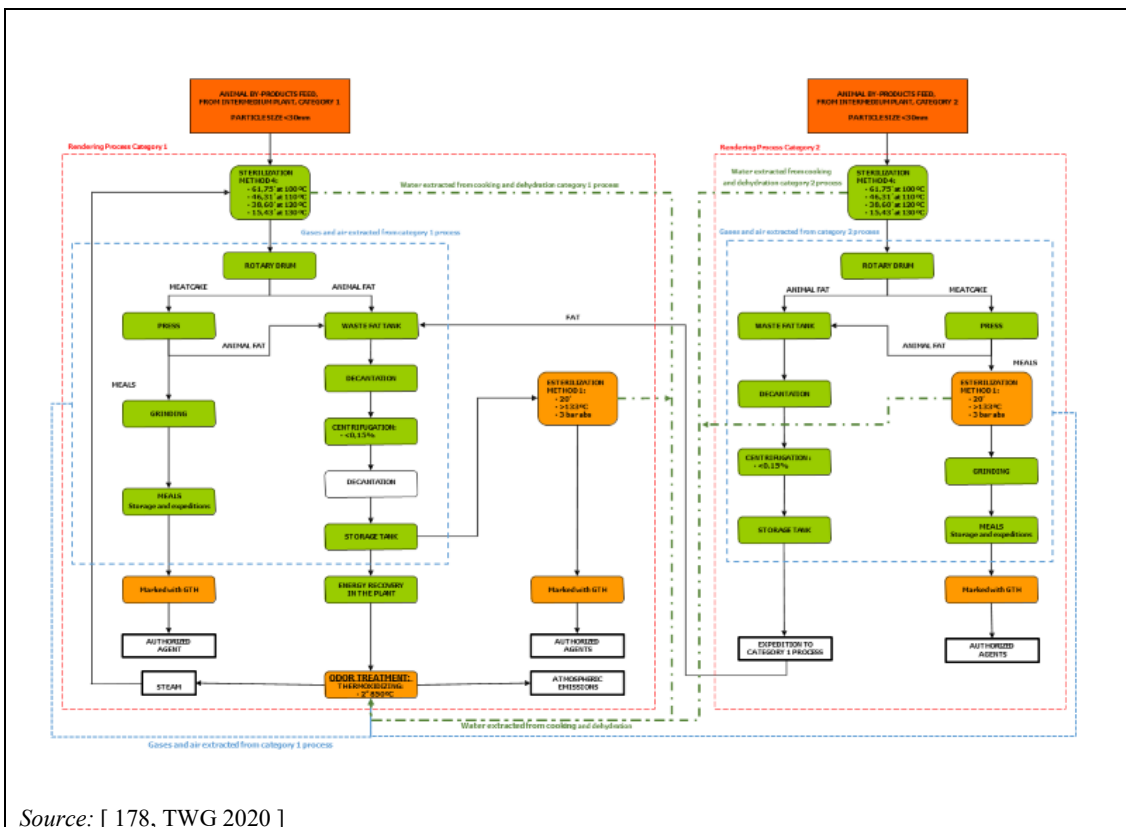

Figure 9.5: Flowchart of a rendering process

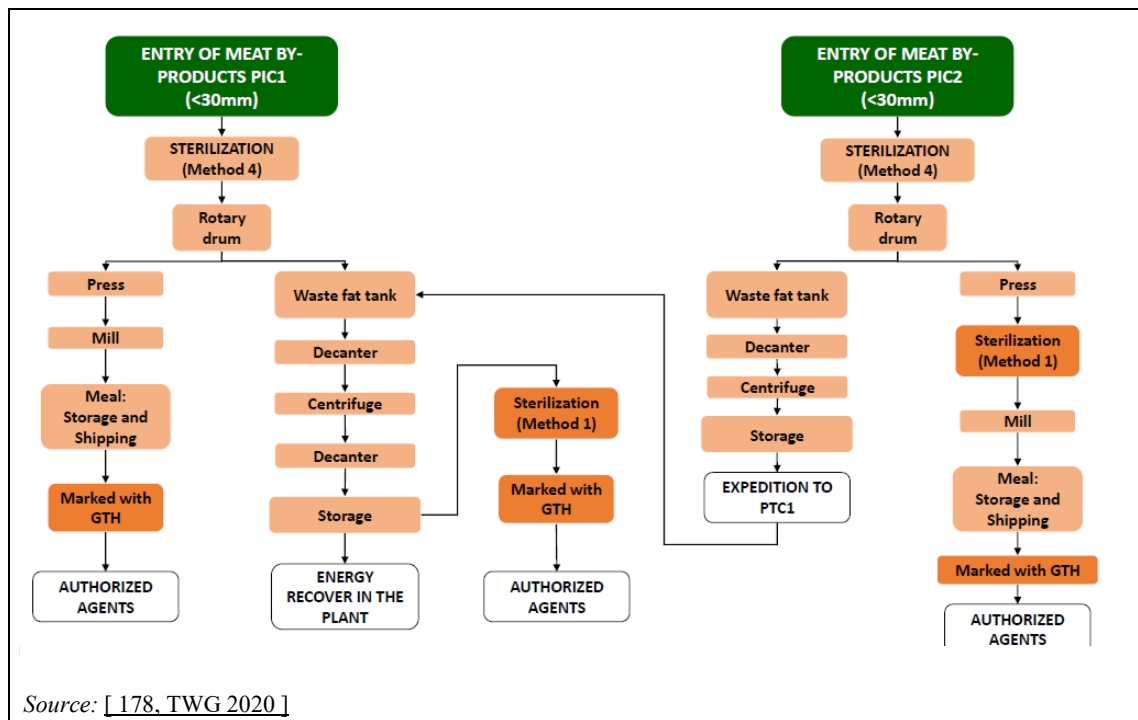

Figure 9.6: Flowchart of a rendering process

Figure 9.7 and Figure 9.8 present flowcharts of emissions to air from rendering installations.

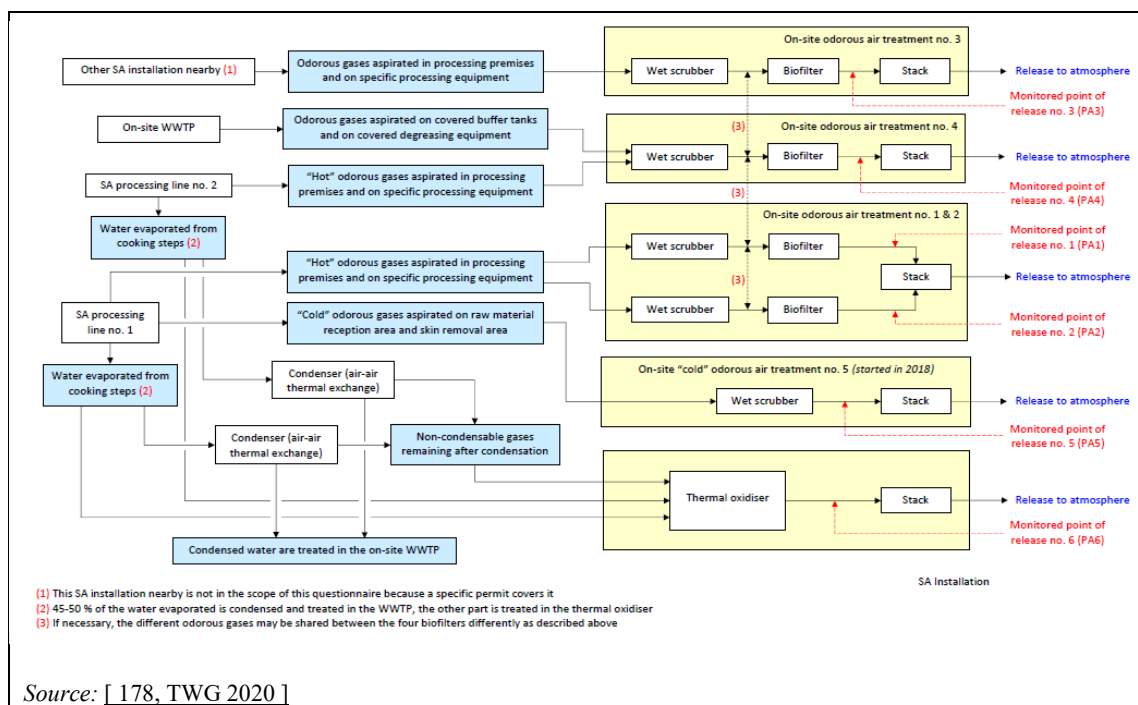
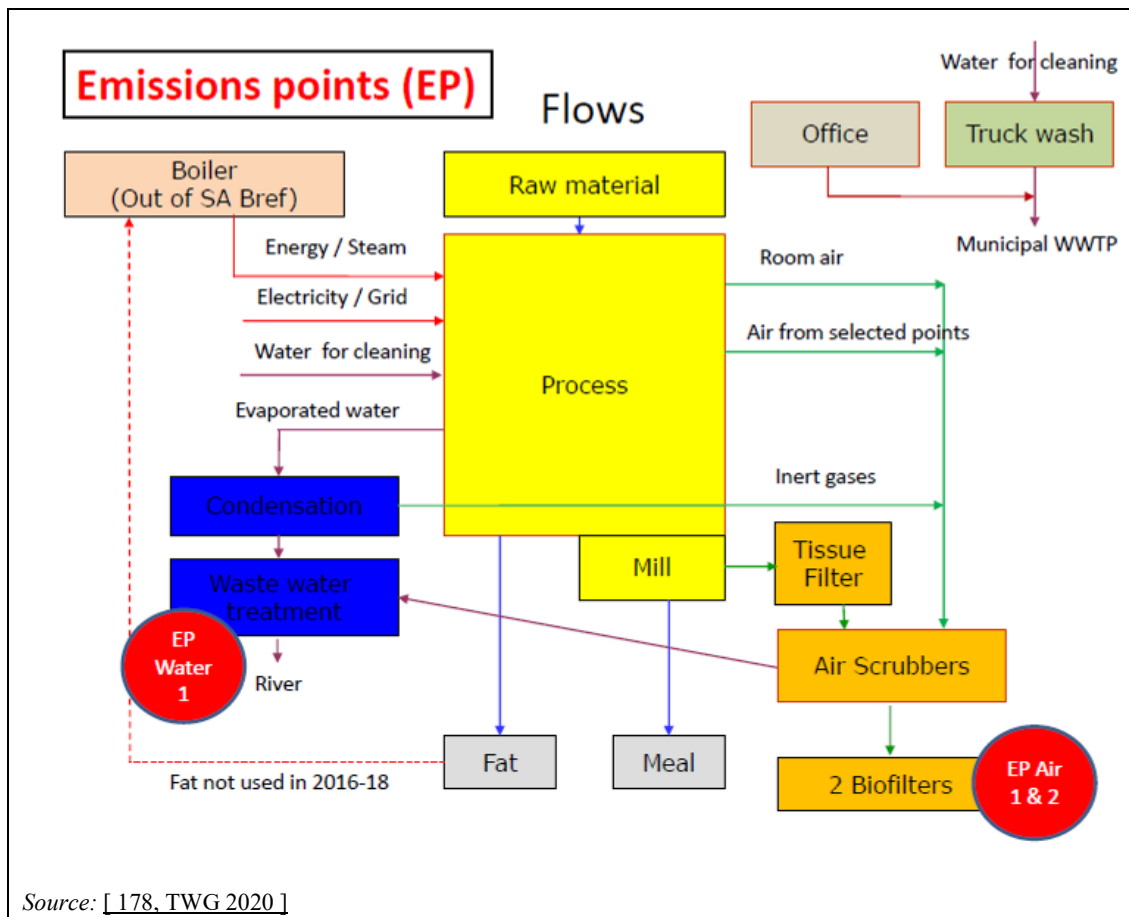

Figure 9.7: Flowchart of emissions to air from a rendering installation



Source: [178, TWG 2020]

Figure 9.8: Flowchart of emissions to air from a rendering installation

10 GLOSSARY

This glossary is meant to facilitate the understanding of the information contained in this document. The definitions of terms in this glossary are not legal definitions (even if some of them may coincide with definitions given in European legislation), they are meant to help the reader understand some key terms in the context of their use in the specific sector covered by this document.

This glossary is divided into the following sections:

- I. ISO country codes
- II. Monetary Units
- III. Unit prefixes, number separators and notations
- IV. General terms, abbreviations, acronyms and substances
- V. Common units, measures and symbols
- VI. List of chemical elements and compounds

I. ISO country codes

ISO code	Country
<i>Member States (*)</i>	
BE	Belgium
BG	Bulgaria
CZ	Czech Republic
DK	Denmark
DE	Germany
EE	Estonia
IE	Ireland
EL	Greece
ES	Spain
FR	France
HR	Croatia
IT	Italy
CY	Cyprus
LV	Latvia
LT	Lithuania
LU	Luxembourg
HU	Hungary
MT	Malta
NL	Netherlands
AT	Austria
PL	Poland
PT	Portugal
RO	Romania
SI	Slovenia
SK	Slovakia
FI	Finland
SE	Sweden
<i>Non-member countries</i>	
NO	Norway
UK	United Kingdom
US	United States
(*) The protocol order of the Member States is based on the alphabetical order of their geographical names in the original language(s).	

II. Monetary units

Code ⁽¹⁾	Country/territory	Currency
<i>Member State currencies</i>		
EUR	Euro area ⁽²⁾	euro (pl. euros)
DKK	Denmark	Danish krone (pl. kroner)
<i>Other currencies</i>		
GBP	United Kingdom	pound sterling
USD	United States	US dollar
<p>⁽¹⁾ ISO 4217 codes. ⁽²⁾ Includes Austria, Belgium, Croatia, Cyprus, Estonia, Finland, France, Germany, Greece, Ireland, Italy, Latvia, Lithuania, Luxembourg, Malta, the Netherlands, Portugal, Slovakia, Slovenia and Spain.</p>		

III. Unit prefixes, number separators and notations

Numbers in this document are written using the '.' character as the decimal separator and the space as the separator for thousands.

The symbol ~ is the notation used to indicate approximation.

The following table contains the frequently used prefixes:

Symbol	Prefix	10 ⁿ	Word	Decimal Number
G	giga	10 ⁹	Billion	1 000 000 000
M	mega	10 ⁶	Million	1 000 000
k	kilo	10 ³	Thousand	1 000
h	hecto	10 ²	Hundred	100
da	deca	10 ¹	Ten	10
-----	-----	1	One	1
d	deci	10 ⁻¹	Tenth	0.1
c	centi	10 ⁻²	Hundredth	0.01
m	milli	10 ⁻³	Thousandth	0.001
μ	micro	10 ⁻⁶	Millionth	0.000 001
n	nano	10 ⁻⁹	Billionth	0.000 000 001

IV. General terms, abbreviations, acronyms and substances

ABP	Animal by-products.
ABP Regulation	Regulation (EC) No 1069/2009 of the European Parliament and of the Council of 21 October 2009 laying down health rules as regards animal by-products and derived products not intended for human consumption and repealing Regulation (EC) No 1774/2002 (Animal by-products Regulation). Regulation (EC) No 1069/2009 has been implemented by Commission Regulation (EU) No 142/2011.
Acid	Proton donor. A substance that, more or less readily, gives off hydrogen ions in a water solution.
Activated sludge process	A sewage treatment process by which bacteria that feed on organic wastes are continuously circulated and put come into contact with organic waste in the presence of oxygen to increase the rate of decomposition.
Aeration	The act of mixing a liquid with air (oxygen).
Alkali	Proton acceptor. A substance that, more or less readily, takes up hydrogen ions in a water solution.
Ammoniacal nitrogen	Nitrogen present as ammonia and ammonium ion in liquid effluents.
Anaerobic	A biological process which occurs in the absence of oxygen.
Animal meal	See 'processed animal proteins'.
AOX	Adsorbable organically bound halogens, expressed as Cl, include adsorbable organically bound chlorine, bromine and iodine.
Biocoenosis	Association of different organisms forming a closely integrated community; relationship existing between such organisms.
BFB	Bubbling fluidised bed.
Biochemicals	Chemicals that are either naturally occurring or identical to naturally occurring substances. Examples include hormones, pheromones and enzymes. Biochemicals function as pesticides through non-toxic, non-lethal modes of action, such as disrupting the mating pattern of insects, regulating growth or acting as repellents.
Biodegradable	That can be broken down physically and/or chemically by microorganisms. For example, many chemicals, food scraps, cotton, wool and paper are biodegradable.
Biochemical oxygen demand (BOD _n)	Amount of oxygen needed for the biochemical oxidation of the organic matter to carbon dioxide in <i>n</i> days (<i>n</i> is typically 5 or 7). BOD is an indicator for the mass concentration of biodegradable organic compounds.
Bovine	Of or like an ox.
Bristles	Hairs [20, MLC 1999].
BSE	Bovine spongiform encephalopathy.
Caprine	Of or like a goat.
Casings	The outer layer of meat products such as sausages, i.e. the skin of a sausage, produced from intestines [20, MLC 1999].
Category 1	See definition in the 'ABP Regulation'.
Category 2	See definition in the 'ABP Regulation'.
Category 3	See definition in the 'ABP Regulation'.
CEN	European Committee for Standardisation.
CIP	Cleaning-in-place.
CHP	Cogeneration of heat and power.
Chemical oxygen demand (COD)	Amount of oxygen needed for the total chemical oxidation of the organic matter to carbon dioxide using dichromate. COD is an indicator for the mass concentration of organic compounds.
DAF	Dissolved air flotation.
Denitrification	Biological process by which nitrate is converted to nitrogen gas and other gaseous end products.
Dressing	The process of removing various parts of the body of an animal following slaughter.
DS	Dry solids (content). The mass of a material remaining after drying by the standard method of test.

EA	Environment Agency of England and Wales.
EAPA	European Animal Protein Association.
EDTA	Ethylene diamine tetraacetic acid.
Effluent	Physical fluid (air or water together with contaminants) forming an emission.
EFPPRA	European Fat Processors and Renderers Association
EFSA	European Food Safety Authority.
EIPPCB	European IPPC Bureau.
ELV	Emission limit value.
Emission	The direct or indirect release of substances, vibrations, heat or noise from individual or diffuse sources in the installation into air, water or land.
Emission limit value	The mass, expressed in terms of certain specific parameters, concentration and/or level of an emission, which may not be exceeded during one or more periods of time.
End-of-pipe technique	A technique that reduces final emissions or consumption by some additional process but does not change the fundamental operation of the core process. Synonyms: 'secondary technique', 'abatement technique'. Antonyms: 'process-integrated technique', 'primary technique' (a technique that in some way changes the way in which the core process operates thereby reducing raw emissions or consumption).
EPA	Environmental Protection Agency.
EURA	European Renderers Association (amalgamated with UNEGA in 2001 to form EFPPRA).
EVC	Exhaust vapour condensate.
Evisceration	The removal of the viscera from the carcass [20, MLC 1999].
Eutrophication	The pollution of a body of water by sewage, fertilisers washed from the land, and industrial wastes (inorganic nitrates and phosphates). These compounds stimulate the growth of algae, reducing the oxygen content in the water, and so killing animals with a high oxygen requirement.
FFA	Free fatty acid.
Fleshing	Eliminating subcutaneous tissue, fat and flesh adhering to the hide or skin, manually or by the mechanical action of a cylinder equipped with cutting blades.
F/M ratio	Food to microorganism ratio.
FOG	Fats, oils and greases.
Gambrelling table	A table that is free-standing or bolted to the de-hairing machine. It is a substantial rigid table with a self-draining top designed to receive the carcass after it is discharged from the de-hairing machine, to enable the operatives to cut the gam (part of the leg of the pig) and insert the 'gambrel', prior to the carcass being elevated onto the dressing line
Grax	An intermediate solid phase, with a high water content, produced during rendering and fishmeal manufacture.
Greaves	The solid product of fat melting.
HCFC	Hydrochlorofluorocarbon.
Hollow knife	Knife used to bleed carcasses, with a hollow blade through which blood runs through the handle and a tube to a collection vessel.
HPLV	High-pressure low-volume.
HRT	Hydraulic retention time (days) (reactor volume (m ³)/influent flow rate (m ³ /d)).
IBC	Intermediate bulk container.
IED	Industrial Emissions Directive (2010/75/EU).
Intestine	Lower part of alimentary canal from pyloric end of stomach to anus.
IPPC	Integrated Pollution Prevention and Control.
Kjeldahl nitrogen	Total concentration of organic nitrogen and ammonia in an organic compound.
Lairage	Area of a slaughterhouse where animals are held before slaughter.
LECA	Light expanded clay aggregate.
LPG	Liquefied petroleum gas.
LT	Low-temperature dryer – vacuum dryer
Maturation	The holding of carcasses or standard cuts at refrigerated temperatures (0-4 °C) to improve eating quality [20, MLC 1999].

MBM	Meat and bone meal - an animal meal produced from meat and bones (see 'processed animal proteins').
MBTF	Moving bed trickling filter.
Mesophilic	Organisms for which the optimum temperature for growth is within the range of 20-45 °C.
Min	Minute(s).
MLC	Meat and Livestock Commission.
MLVSS	Mixed-liquor volatile suspended solids.
Monitoring	Process intended to assess or to determine the actual value and the variations of an emission or another parameter, based on procedures of systematic, periodic or spot surveillance, inspection, sampling and measurement or another assessment method intended to provide information about emitted quantities and/or trends for emitted pollutants.
MS	(European Union) Member State(s).
Mucosa	Mucose membrane.
N	Normality of solution, i.e. gram-equivalent of solute per cubic decimetre.
n/a (or NA)	Not applicable.
N D	Not detectable.
Nitrification	Biological process by which ammonia is converted first to nitrite and then to nitrate.
Nitrogen (ammoniacal)	Nitrogen present as ammonia and ammonium ions in liquid effluents.
Nitrogen (Kjeldahl)	Ammoniacal nitrogen and nitrogen in an organic compound.
Offal	The edible or inedible soft tissues, i.e. excluding bone, of a carcass removed during the dressing of the carcass of an animal killed for food. Green offal is the digestive tract and associated organs and red offal is the more commonly consumed offal from the carcass such as the liver, kidney and heart [20, MLC 1999].
Operator	Any natural or legal person who operates or controls in whole or in part the installation or combustion plant or waste co-incineration plant or, where this is provided for in national legislation, to whom decisive economic power over the technical functioning of the installation has been delegated.
OTMS	Over Thirty Months Scheme.
ou _E	European odour unit.
Paunch	Stomach contents.
Pithing	Slaughter or immobilisation of the animal by severing the spinal cord, achieved by pushing a nylon rod through the hole left by the captive bolt.
PLC	Programmable logic control.
Prion	Hypothetical proteinaceous infectious particle consisting only of protein, thought to be the cause of diseases such as TSE and scrapie.
Processed animal proteins	Meat and bone meal, meat meal, bone meal, blood meal, dried plasma and other blood products, hydrolysed proteins, hoof meal, horn meal, poultry offal meal, feather meal, dry greaves, fishmeal, dicalcium phosphate, gelatine and any other similar products including mixtures, feedingstuffs, feed additives and premixtures, containing these products (from 2000/766/EC Council Decision of 4 December 2000 concerning certain protection measures with regard to transmissible spongiform encephalopathies and the feeding of animal protein [16, COM 2000]).
PSE	Pale, soft and exudative meat.
Relative density	Specific gravity.
SBR	Sequencing batch reactor.
SCR	Selective catalytic reduction.
Singeing	The burning off of hairs from a pig carcass [20, MLC 1999].
SNCR	Selective non-catalytic reduction.
SRM	Specified risk material.
SS	Suspended solids (content) (in water) (see also TSS).
Standard cuts	Carcasses, half carcasses, half carcasses cut into no more than three wholesale cuts and quarters.
Stunning	Refers to methods used to render an animal insensible to pain, causing unconsciousness, at slaughter [20, MLC 1999].

Glossary

SWC	Specific water consumption - the volume of water used to process one tonne of meat.
Tallow	Animal fat separated from the solid (protein/meal) and water fractions of animal tissue, by rendering (the term is usually applied to fat which is either inedible or not intended for human consumption).
Therm	A unit of energy, equivalent to 106 MJ.
TKN	Total Kjeldahl nitrogen.
TMA	Trimethylamine.
Total nitrogen (Total N)	Total nitrogen, expressed as N, includes free ammonia and ammonium nitrogen (NH ₄ -N), nitrite nitrogen (NO ₂ -N), nitrate nitrogen (NO ₃ -N) and organically bound nitrogen.
Total phosphorus (Total P)	Total phosphorus, expressed as P, includes all inorganic and organic phosphorus compounds, dissolved or bound to particles.
TSE	Transmissible spongiform encephalopathy.
Total suspended solids (TSS)	Mass concentration of all suspended solids (in water), measured via filtration through glass fibre filters and gravimetry.
TVN	Total volatile nitrogen.
UKRA	United Kingdom Renderers Association.
UNEGA	European Animal Fat Processors Association (amalgamated with EURA in 2001 to form EFPRA).
Viscera	Offal from the thoracic, abdominal and pelvic cavities, including the trachea and oesophagus (large animals) [33, COM 1991] or offal from the thoracic, abdominal and pelvic cavities, and also, where appropriate, the trachea, oesophagus and crop (poultry) [55, COM 1992].
VHR	Volumetric heat release rate.
VOC	Volatile organic compound.
WWTP	Waste water treatment plant.

V. Common units, measures and symbols

bar	bar (1.013 bar = 1 atm)
Bé	(or°B) degree Baumé - a unit of relative density. For liquids lighter than water, the relative density d in °Bé is related to relative density "S" by the formula $d = (144.3/S) - 144.3$ and for heavier liquids the formula is $d = 144.3 - (144.3/S)$
°C	degree Celsius
cm	centimetre
d	day
g	gram
GJ	gigajoule
h	hour
Hz	Hertz
J	Joule
kg	kilogram (1 kg = 1000 g)
kPa	kilopascal
kWh	kilowatt hour (1 kWh = 3600 kJ = 3.6 MJ)
l	litre(s)
m	metre(s)
m ²	square metre
m ³	cubic metre
mg	milligram (1 mg = 10 ⁻³ gram)
MJ	megajoule (1 MJ = 1000 kJ = 10 ⁶ J)
MPa	megapascal
N	normality of solution, i.e. gram-equivalents of solute per cubic decimetre (see context – fix for final draft)
ng	nanogram (1 ng = 10 ⁻⁹ gram)
Nm ³	normal cubic metre
ou _E	European odour unit
Pa	pascal
s	second
t	metric tonne
t/d	tonnes per day
t/yr	tonnes per year
Therm	a unit of energy, equivalent to 10 ⁶ MJ
yr	year
µm	micrometre (1 µ = 10 ⁻⁶ m)

VI. List of chemical elements and compounds

Al	Aluminium
As	Arsenic
Ba	Barium
C	Carbon
Ca	Calcium
CaCl ₂	Calcium chloride
Ca(H ₂ PO ₄) ₂	Calcium phosphate
Ca ₃ (PO ₄) ₂	Tricalcium phosphate
CaCO ₃	Calcium carbonate
Cd	Cadmium
CH ₄	Methane
Cl	Chlorine
Co	Cobalt
CO	Carbon monoxide
CO ₂	Carbon dioxide
Cr	Chromium
Cu	Copper
F	Fluorine
FeCl ₂	Iron II chloride (ferrous chloride)
HCl	Hydrochloric acid or hydrogen chloride
H ₂ CO ₃	Carbonic acid
Hg	Mercury
H ₂ O	Water
H ₂ S	Hydrogen sulphide
H ₂ SO ₄	Sulphuric acid
K	Potassium
Mg	Magnesium
Mn	Manganese
N	Nitrogen (see context – fix for final draft)
Na	Sodium
NaOH	Sodium hydroxide
NH ₃	Ammonia
Ni	Nickel
NO _x	Oxides of nitrogen
NO ₂	Nitrogen dioxide
N ₂ O	Nitrous oxide
NPE	Nonyl phenol ethoxylate
O	Oxygen
P	Phosphorus
Pb	Lead
Si	Silicon
S	Sulphur
SO ₂	Sulphur dioxide
Tl	Thallium
V	Vanadium

11 REFERENCES

- [1] EPA, *Integrated Pollution Control Licensing Batneec Guidance Note For The Slaughter of Animals*, EPA No.LC 17(9/96), 1996.
- [2] EPA, *Integrated Pollution Control licensing Batneec Guidance Note For The Rendering of Animal By-products*, EPA No.LC 13(10/96), 1996.
- [3] Environment Agency, *Processes Subject to Integrated Pollution Control Animal Remains Incineration - Amplification note*, S2 5.01 Amplification note No. 1, 1997.
- [4] WS Atkins-EA, *Model Approach for Producing BAT Guidance for Specific Sub-sectors within the Food and Drink Industry, Red Meat Abattoirs*, 2000.
- [5] University of Guelph, *Slaughtering*, 2000.
- [6] EPA, *Air Pollution Control Regulations, Regulation Number 62.1, Definitions, Permit Requirements and Emissions Inventory, Regulation Number 62.1*, 1997.
- [7] DoE SO and WO, *Secretary of State's Guidance – Fish meal and fish oil processes*, PG6/19(97), 1997.
- [8] VDI, *Emission control. Animal by-products processing plants. VDI2590*, 2008.
- [9] DoE, *Red meat plants, Guide 32*, 1993.
- [10] ETBPP, *Reducing the cost of cleaning in the food and drink industry, Good Practice Guide GG 154*, 1998.
- [11] ETBPP, *Reducing water and effluent costs in red meat abattoirs, Good Practice Guide GG 234*, 2000.
- [12] Environment Agency, *Processes subject to Integrated Pollution Control – Waste Incineration, S2 5.01*, 1996.
- [13] WS Atkins-EA, *BAT Guidance for Specific Sub-sectors within the Food and Drink Industry, Poultry Processors*, 2000.
- [14] EA, *Processes Subject to Integrated Pollution Control, Combustion of Meat and Bone Meal (MBM), S2 1.05 Amplification note No. 1*, 1998.
- [15] COM, 99/724/EC: *Commission Decision of 28 October 1999 amending Annex II to Council Directive 92/118/EEC laying down animal health and public health requirements governing trade in and imports into the Community of products not subject to the said requirements laid down in specific Community rules referred to in Annex A (I) to Directive 89/662/EEC and, as regards pathogens, to Directive 90/425/EEC (notified under document number C(1999) 3493) (Text with EEA relevance)*, 1999.
- [16] COM, *Council Decision of 4 December 2000 concerning certain protection measures with regard to transmissible spongiform encephalopathies and the feeding of animal protein*, 2000.
- [17] COM, *Council Directive 64/433/EEC of 26 June 1964 on health problems affecting intra-Community trade in fresh meat*, 1964.
- [18] COM, *Report on Implementation of Latest BSE Control Measures in the Member States Working document*, 2001.
- [19] COM, 2001/2/EC: *Commission Decision of 27 December 2000 amending Decision 2000/418/EC regulating the use of material presenting risks as regards transmissible spongiform encephalopathies (Text with EEA relevance) (notified under document number C(2000) 4147)*, 2000.
- [20] MLC, *A glossary of carcase and meat quality terms*, 0 1908 677577, 1999,
- [21] COM, *Council Regulation (EC) No 1099/2009 of 24 September 2009 on the protection of animals at the time of killing*, 2009.
- [22] MLC, *The Abattoir and Meat Processing Industry in Great Britain, 1999 edition*, 0 904650 75 8, 1999.
- [23] Nordic, *Best Available Techniques (BAT) in Nordic Slaughterhouses*, 2001.

References

- [24] Det Norske Veritas, *Environmental Assessment of Options for the Utilisation or Disposal of Animal By-products for UKRA*, 2001.
- [25] DHV, *Moving bed trickling filter: Cost-effective treatment of water, air and air/water mixtures*, 1999.
- [26] Finnish Environment Institute and Finnish Food and Drink Industries' Federation, *The Finnish Background Report for the EC documentation of the best available techniques for slaughterhouses and installations for the disposal or recycling of animal carcasses and animal waste*, 2001.
- [27] Danish Institute of Agricultural and Fisheries Economics, *Centralised Biogas Plants - Integrated Energy Production, Waste Treatment and Nutrient Redistribution Facilities*, 1999.
- [28] Nordic Council of Ministers, *Best Available Technology in the Fishing Industry*, 1997.
- [29] Germany, *Best Available Techniques Reference Document on the Slaughterhouses and Animal By-products Industry*, 2001.
- [30] Nottrodt, *Guideline for Technical Requirements and General Recommendations for the disposal of Meat and Bone Meal and Tallow*, 2001.
- [31] Greek Ministry for the Environment, *Food industry IPPC study*, 2001.
- [32] Sweeney L., Personal communication, 2001.
- [33] COM, *Council Directive 91/497/EEC of 29 July 1991 amending and consolidating Directive 64/433/EEC on health problems affecting intra-Community trade in fresh meat to extend it to the production and marketing of fresh meat*, 1991.
- [34] COM, *Regulation (EC) No 999/2001 of the European Parliament and of the Council of 22 May 2001 laying down rules for the prevention, control and eradication of certain transmissible spongiform encephalopathies*, 2001.
- [35] The Composting Association, *Large-scale composting - a practical manual for the UK*.
- [36] COM, *Directive 2000/60/EC of the European Parliament and of the Council of 23 October 2000 establishing a framework for Community action in the field of water policy*, 2000.
- [37] Pontoppidan O., *Techniques to consider in the determination of BAT – slaughter*, 2001.
- [38] EURA, *Rendering, thermal oxidation and gasification information*, 2000.
- [39] Therma CCT, *Therma CCT*, 2000.
- [40] Widell S., *Information about odour control at rendering, incineration and biogas production*, Personal communication, 2001.
- [41] APC Europe, *A TSE risk analysis for spray-dried plasma*, 2001.
- [42] Tritt W. P. and Schuchardt F., *Materials flow and possibilities of treating liquid and solid wastes from slaughterhouses in Germany – A review*, *Bioresource technology*, pp. 235 - 245, 1992.
- [43] Linköping Gas AB, *Waste to fuel*, 1997.
- [44] Croda Colloids Ltd, *Bone degreasing process*, 2000.
- [45] The Composting Association, *A guide to in-vessel composting plus a directory of systems*, 0 9532546 0 7, 2000.
- [46] Environment Agency, *Technical Guidance on Composting Operations – Draft for external consultation*, 2001.
- [47] Nielsen E.W., *Information about fish-meal and fish-oil*, Personal communication, 2001.
- [48] Nielsen E.W., *Fish-meal and fish-oil production – Information*, Personal communication, 2001.
- [49] AVEC, *Poultry slaughter information*, 2001.
- [50] Durkan J., *Waste water treatment; data for cattle*, Personal communication, 2001.
- [51] Metcalf and Eddy, *Wastewater engineering*, 0 07 100824 – 1, 1991.
- [52] Brindle J., *Information about carcase washing in slaughterhouses*, Personal communication, 2001.

- [53] APC Europe, Personal communication, 2001.
- [54] Gordon W., *Centralised Biogas Plants, A report for the British Poultry Council*, 2001.
- [55] COM, *Council Directive 92/116/EEC of 17 December 1992 amending and updating Directive 71/118/EEC on health problems affecting trade in fresh poultrymeat*, 1992.
- [56] Germany, *Techniques to consider BAT*, 2002.
- [57] Italy, *Comments on first draft of the "Slaughterhouses and animal by-products BREF"*, 2002.
- [58] UECEBV, *Comments on first draft of the "Slaughterhouses and animal by-products BREF"*, 2002.
- [59] The Netherlands, *Comments on first draft of the "Slaughterhouses and animal by-products BREF"*, 2002.
- [60] United Kingdom, *Comments on first draft of the "Slaughterhouses and animal by-products BREF"*, 2002.
- [61] Belgium, *Comments on first draft of the "Slaughterhouses and animal by-products BREF"*, 2002.
- [62] Germany, *Comments on first draft of the "Slaughterhouses and animal by-products BREF"*, 2002.
- [63] AVEC, *Comments on first draft of the "Slaughterhouses and animal by-products BREF"*, 2002.
- [64] Sorlini G., *Comments on first draft of the "Slaughterhouses and animal by-products BREF"*, 2002.
- [65] GME, *Description of the gelatine manufacturing process*, 2002.
- [66] Raj A.B.M., *Recent developments in humane slaughter of poultry (1998) updated to include recent commercial developments and changes to the Animal Welfare Regulations (Statutory Instrument No. 3830)*, Personal communication, 2002.
- [67] EAPA, *Comments on first draft of the "Slaughterhouses and animal by-products BREF"*, 2002.
- [68] UNEP, *Promoting Cleaner Production in the Industrial Sector*, 2002.
- [69] May G.E., Personal communication, 2001.
- [70] Tauw, *Description of techniques for reducing emissions to air – Biotrickling*, 2000.
- [71] IFFO, *Comments on first draft of the "Slaughterhouses and animal by-products BREF"*, 2002.
- [72] Ockerman H.W. and Hansen C.L., *Animal by-product processing and utilisation, I-56676-777-6*, 2000.
- [73] Italy, *Information from site visits*, Personal communication, 2002.
- [74] Casanellas J., Personal communication, 2002.
- [75] Woodgate S., Personal communication, 2002.
- [76] Black et al., *Reference Document on Best Available Techniques for the Tanning of Hides and Skins*, European Commission, Joint Research Centre, 2013.
- [77] Pontoppidan O., Personal communication, 2002.
- [78] Anão M., Personal communication, 2002.
- [79] Savini F., *Heat recovery from singeing*, Personal communication, 2002.
- [80] Palomino S., Personal communication, 2002.
- [81] Brindle J., Personal communication, 2002.
- [82] COTANCE, *Treatment of hides and skins undertaken at slaughterhouses*, 2002.
- [83] Durkan J., *Comments on first draft of the "Slaughterhouses and animal by-products BREF"*, 2002.
- [84] Rodgers K., *Re-use of crate washing water*, 2002.
- [85] ETSU, *Running refrigeration plant efficiently – a cost effective guide for owners, Good practice guide 279*, 2000.

References

- [86] Smith T., *Information supplied following intermediate meeting 23rd, 24th April 2002 to discuss dedicated incineration of animal by-products*, 2002.
- [87] HSE, *The storage of flammable liquids in tanks*, 1998.
- [88] Environment Agency, *Horizontal Guidance for noise – Part 1 Regulation and permitting*, 2002.
- [89] Environment Agency, *Horizontal Guidance for noise – Part 2 Noise assessment and control*, 2002.
- [90] ETSU, *A new refrigeration system in a small coldstore*, 1999.
- [91] Jimenéz R., *Use of SBR in slaughterhouse waste water treatment*, 2002.
- [92] Minck F., Personal communication, 2002.
- [93] Hydrotech Water and Environmental Engineering Ltd, *Englezakis Ostrich Farms Study of the Wastewater Treatment Plant*, 2001.
- [94] Hupkes H., *Supplementary information after first draft*, 2002.
- [95] Oberthur R., Personal communication, 2002.
- [96] CEN, *EN 13725:2022 – Stationary source emissions – Determination of odour concentration by dynamic olfactometry and odour emission rate*, CEN standard, 2022.
- [97] Biosphere Refineries Corporation, *Bio-refining technology that converts organic wastes and by-products into sterile fertilizers and soil amendments*, 2002.
- [98] RenCare, *Information Booklet on the Processing of Animal Waste using a RenCare - AW2 installation*, 2002.
- [99] Czechia, Personal communication, 2002.
- [100] Italy, *Comments on second draft of the "Slaughterhouses and animal by-products BREF"*, 2003.
- [101] COTANCE, *Comments on second draft of the "Slaughterhouses and animal by-products BREF"*, 2003.
- [102] The Netherlands, *Comments on second draft of the "Slaughterhouses and animal by-products BREF"*, 2003.
- [103] BPFM, *Basic requirements for bird handling and unloading*, 2003.
- [104] Brechtelsbauer P., *Separation of grease, floating and settling material in the food industry*, 2003.
- [105] Belgium, *Comments on second draft of the "Slaughterhouses and animal by-products BREF"*, 2003.
- [106] Germany, *Comments on second draft of the "Slaughterhouses and animal by-products BREF" and associated e-mails*, 2003.
- [107] United Kingdom, *Comments on second draft of the "Slaughterhouses and animal by-products BREF"*, 2003.
- [108] Clitravi - DMRI, *Comments on second draft of the "Slaughterhouses and animal by-products BREF"*, 2003.
- [109] AVEC, Personal communication, 2003.
- [110] Nordic Council of Ministers, *Slaughterhouses and producers of Animal By-products in the Nordic Countries*, Personal communication, 2016.
- [111] Finnish Environment Institute, *Finnish Expert Report on Best Available Techniques in Slaughterhouses and Installations for the Disposal or Recycling of Animal Carcasses and Animal Waste*, 2002.
- [112] Falcke et al., *Best Available Techniques (BAT) Reference Document for the Production of Large Volume Organic Chemicals (LVOC BREF)*, European Commission, Joint Research Centre, 2017.
- [113] Waxwender et al., *Austria - State of the art of the Slaughter and Animal By-Products Industries*, Umweltbundesamt Wien, 2016.

- [114] COM, *Kick-off meeting for the review of the best available techniques (BAT) reference document for the Slaughterhouses and Animal By-product Industries*. Meeting report, 2019.
- [115] EFPPA, *Rendering in Numbers*, 2019.
- [116] COM, *Commission Regulation (EU) No 142/2011 of 25 February 2011 implementing Regulation (EC) No 1069/2009 of the European Parliament and of the Council laying down health rules as regards animal by-products and derived products not intended for human consumption and implementing Council Directive 97/78/EC as regards certain samples and items exempt from veterinary checks at the border under that Directive (version consolidated in 2019)*, 2011.
- [117] Danish Technological Institute, *BREF Slaughterhouses and Animal By-Products Influence on consumption and emission levels from slaughter-houses*, 2019.
- [118] Denmark, *Update of information concerning environmental issues of slaughterhouses*, 2015.
- [119] EC, *Regulation (EC) No 1069/2009 of the European Parliament and the Council of 21 October 2009 laying down health rules as regards animal by-products and derived products not intended for human consumption and repealing Regulation (EC) No 1774/2002 (Animal by-products Regulation)*, 2009.
- [120] Aries et al., *Reference Document on Best Available Techniques for Ferrous Metals Processing Industry*, European Commission, Joint Research Centre, 2022.
- [121] Giner-Santonja et al., *Best Available Techniques (BAT) Reference Document for the Food, Drink and Milk Industries*, European Commission, Joint Research Centre, 2019.
- [122] European Fishmeal, *European Fishmeal input to the SA BREF TWG*, 2019.
- [123] Ireland, *One Health Report on Antimicrobial Use; Antimicrobial Resistance*, 2019.
- [124] Germany, *Antibiotics and Antibiotic Resistances in the Environment. Background, Challenges and Options for Action*, 2018.
- [125] Chemicals, *Electrocoagulation-new technology for the wastewater treatment*. Retrieved from Data Research Analyst: <http://www.worldofchemicals.com/18/chemistry-articles/electrocoagulation-new-technology-for-the-wastewater-treatment.html>, 2019.
- [126] Nwabanne et al., *Abattoir Wastewater Treatment by Electrocoagulation Using Iron Electrodes*, Pelagia Research Library Vol. 8(2), pp. 254-260, 2017.
- [127] VITO, *Elektrocoagulatie*. Retrieved from WASS (WATERZUIVERINGSSELECTIESYSTEEM): <https://emis.vito.be/nl/techniekfiche/elektrocoagulatie>, 2019.
- [128] Bustillo-Lecompte et al., *Slaughterhouse Wastewater Characterization and Treatment: An Economic and Public Health Necessity of the Meat Processing Industry in Ontario, Canada*, Journal of Geoscience and Environment Protection Vol. 4, pp. 175-186, 2016.
- [129] Ozyonar et al., *Investigation of technical and economic analysis of electrocoagulation process for the treatment of great and small cattle slaughterhouse wastewater*, Desalination and Water Treatment, Vol. 52 1-3, pp. 74-87, 2013.
- [130] COM, *Best Available Techniques (BAT) Reference Document in the Slaughterhouses and Animal By-products Industries (SA BREF)*, 2005.
- [131] Kazem et al., *Electrochemical treatment of Poultry Slaughterhouse Wastewater using Iron and Aluminium Electrodes*, Research Journal of Chemistry and Environment Vol. 16(3), pp. 98-103, 2012.
- [132] MLA, *Electrocoagulation Process for Wastewater Treatment*, Livestock Australia, 2003.
- [133] Vizzier-Thaxton et al., *A new humane method of stunning broilers using low atmospheric pressure*, The Journal of Applied Poultry Research Vol. 19 (4), pp. 341-348, 2010.
- [134] The Poultry Site, *EU Regulation Changes View on Stunning at Slaughter (July 2013)*, 2019.
- [135] COM, *Study on various methods of stunning for poultry*, 2012.
- [136] McKeegan et al., *Physiological responses to low atmospheric pressure stunning and the implications for welfare*, Poultry Science Vol. 92, pp. 858-868, 2013.

References

- [137] EFSA, *Scientific Opinion on the use of low atmosphere pressure system (LAPS) for stunning poultry*, 2014.
- [138] Bantle et al., *Superchilling of organic food*, 2016.
- [139] Kaale et al., *Superchilling of food: A review*, Journal of Food Engineering Vol. 107, pp. 141-146, 2011.
- [140] Bonou et al., *LCA of pork products & evaluation of alternative super-chilling techniques*. Technical University of Denmark, 2016.
- [141] Nagarajan et al., *Heterotrophic Microalgal Cultivation, Bioreactors for Microbial Biomass and Energy Conversion*. Green Energy and Technology. Springer, Singapore, 2018.
- [142] Santos et al., *The bioeconomy of microalgam heterotrophic bioreactors applied to agroindustrial wastewater treatment*, Desalination and water treatment Vol. 64, pp. 12-20, 2017.
- [143] Jacob-Lopes et al., *Cyanobacteria and Carbon Sequestration In: Sharma N. K., Rai A. K., Stal L. J. Cyanobacteria: An economic perspective.*, John Wiley, Hoboken, NJ, USA, 2013.
- [144] Bose et al., *Energy Recovery with Microbial Fuel Cells: Bioremediation and Bioelectricity*, Waste Bioremediation, 2018.
- [145] Ismail et al., *Biotreatment of Slaughterhouse Wastewater Accompanied With Sustainable Electricity Generation in Microbial Fuel Cell*, Systemics, Cybernetics and Informatics Vol. 14 No 2, pp. 30-35, 2016.
- [146] Akaluka et al., *Abattoir wastewater treatment and energy recovery using a Ferricyanide-catholyte Microbial Fuel Cell*, International Letters of Natural Sciences Vol. 55, pp. 68-76, 2016.
- [147] COM, *Novel sustainable techniques - Innovation Observatory*, 2019.
- [148] Chaturvedi et al., *Microbial fuel cell: a green approach for the utilization of waste for the generation of bioelectricity*, Bioresources and Bioprocessing Vol. 3:38, 2016.
- [149] Maddi et al., *Quantitative Characterization of Aqueous Byproducts from Hydrothermal Liquefaction of Municipal Wastes, Food Industry Wastes, and Biomass Grown on Waste*, ACS Sustainable Chem. Eng. Vol. 5 No 3, pp. 2205-2214, 2017.
- [150] García Cortés, *Solution to ABP wastes disposal: the continuous Hydrothermal Liquefaction alternative*. University of Alicante, Sustainable Technologies applied to animal by-products, Alicante, 2020.
- [151] Gollakota et al., *A review on hydrothermal liquefaction of biomass*, Renewable and Sustainable Energy Reviews Vol. 81-1, pp. 1378-1392, 2018.
- [152] Lee et al., *Technical issues in the large-scale hydrothermal liquefaction of microalgal biomass to biocrude*, Current Opinion in Biotechnology Vol. 38, pp. 85-89, 2016.
- [153] Snowden-Swan et al., *Conceptual Biorefinery Design and Research Targeted for 2022: Hydrothermal Liquefaction Processing of Wet Waste to Fuels*. US Department of Energy. https://www.pnnl.gov/main/publications/external/technical_reports/PNNL-27186.pdf, 2017.
- [154] Brinkmann et al., *Best Available Techniques (BAT) Reference Document for Common Waste Water and Waste Gas Treatment/Management Systems in the Chemical Sector (CWW BREF)*, European Commission, Joint Research Centre, 2016.
- [155] Karlis et al., *EIPPCB mission report site visit France SA BREF*, 2019.
- [156] TWG, *Initial positions for the review of the SA BREF*, 2019.
- [157] COM, *Preparatory study for a review of Regulation (EC) No 842/2006 on certain fluorinated GHG*, 2011.
- [158] EC, *Regulation (EU) No 517/2014 of the European Parliament and of the Council of 16 April 2014 on fluorinated greenhouse gases and repealing Regulation (EC) No 842/2006*, 2014.
- [159] EC, *Regulation EC/1005/2009 of the European Parliament and of the Council of 16 September 2009 on substances that deplete the ozone layer*, 2009.
- [160] EFPPRA, *SA BREF Initial Position Response from EFPPRA*, 2019.

- [161] Roth et al., *Best Available Techniques (BAT) Reference Document for the Textiles Industry*, European Commission, Joint Research Centre, 2023.
- [162] COM, *Best Available Techniques (BAT) Reference Document for Energy Efficiency (ENE BREF)*, European Commission, Joint Research Centre, 2009.
- [163] EEA, *Fluorinated greenhouse gases 2019. Data reported by companies on the production, import, export, destruction and feedstock use of fluorinated greenhouse gases in the European Union, 2007-2018*, 2020.
- [164] Giner Santonja et al., *Best Available Techniques (BAT) Reference Document for the Intensive Rearing of Poultry or Pigs (IRPP BREF)*, European Commission, Joint Research Centre, 2017.
- [165] Thornval, *Global monitoring of antimicrobial resistance determinants from slaughter houses waste – a pilot project, Bachelor thesis*, 2019.
- [166] Hendriksen et al., *Global monitoring of antimicrobial resistance based on metagenomics analyses of urban sewage*, Nature Communications Vol. 10, Article number: 1124, 2019.
- [167] Spain, *Comments from Spanish fishmeal and Fish oil Industry to 2005 SA BREF*, Personal communication, 2020.
- [168] Jevons et al., *Economic benefits of membrane technology vs. evaporator*, Desalination Vol. 250, pp. 961-963, 2010.
- [169] Pendashteh et al., *Odor removal from a Fish meal plant by oxidative scrubber, International conference on sustainable development, strategies and challenges with a focus on Agriculture, Natural Resources, Environment and Tourism 24-26 Feb 2015, Tabriz, Iran*, 2015.
- [170] Escudero, *Survey of sodium and calcium hypochlorite*, The Danish Environmental Protection Agency, 2015.
- [171] Jensen et al., *Environmental assessment of AOX cts from use of hypochlorite for disinfection*, Danish Environmental Protection Agency, 2016.
- [172] Brinkmann et al., *JRC Reference Report on Monitoring of Emissions to Air and Water from IED Installations (ROM REF)*, European Commission, Joint Research Centre, Seville, EUR 29261 EN, doi: 10.2760/344197, 2018.
- [173] EFPRA-EAPA, *Information on edible co products*, Personal communication, 2020.
- [174] EC, *Regulation (EC) No 853/2004 of the European Parliament and of the Council of 29 April 2004 laying down specific hygiene rules for food of animal origin*, Official Journal of the European Union Vol. L 139, 2004.
- [175] Water2Return, *H2020 project - Slaughterhouses wastewater treatment*, Personal communication, 2019.
- [176] INERIS, *France - Hazardous substances for the aquatic environment in industrial waste water releases/Sectors*, 2016.
- [177] GME, *Further information on the gelatine manufacturers in Europe*, Personal communication, 2019.
- [178] TWG, *Data collection for the first review of the SA BREF*, Personal communication, 2020.
- [179] Pinasseau et al., *Best Available Techniques (BAT) Reference Document for Waste Treatment (WT BREF)*, European Commission, Joint Research Centre, 2018.
- [180] Lecomte et al., *Best Available Techniques (BAT) Reference Document for Large Combustion Plants (LCP BREF)*, European Commission, Joint Research Centre, 2017.
- [181] VDI, *Emission control. Slaughter facilities. VDI 2596*, 2020.
- [182] ORGALIM, *Jet stream scalding*, Personal communication, 2019.
- [183] COM, *Study on various methods of stunning for poultry*, 2012.
- [184] IWC, *Nozzles fitted with two mixing chambers - Undine*, 2020.
- [185] Karlis et al., *Mission report from site visits in Germany*, 2020.
- [186] Roudier et al., *EIPPCB Mission report: Procavi S.L. in Marchena (Spain)*, 2013.
- [187] GE, *Information on General Electric's LEAP membrane bioreactor system*, 2020.

References

- [188] COM, *COM regulation (EU)2020/735 use of MBM as a fuel in combustion plants*, 2020.
- [189] VDI, *Guideline VDI 3477 - Biological waste gas treatment. Biofilters*, 2016.
- [190] European Fishmeal, *Indirect Hot Air Driers and cross-media effects in the fishmeal industry*, 2020.
- [191] GME, *Gelatine manufacturing processes (GME)*, Personal communication, 2020.
- [192] Saveyn et al., *Towards a better exploitation of the technical potential of Waste to Energy*, European Commission, Joint Research Centre, 2016
- [193] Chronopoulos et al., *Best Available Techniques (BAT) Reference Document on Surface Treatment Using Organic Solvents including Preservation of Wood and Wood Products with Chemicals*, European Commission, Joint Research Centre, 2020.
- [194] COM, *Best Environmental Management Practice for the Food and Beverage Manufacturing Sector*, 2017.
- [195] Colsen b.v., *Phosphorus removal in anaerobic effluent by struvite process: ANPHOS Life project*, 2013.
- [196] Desmidt et al., *Global Phosphorus Scarcity and Full-Scale P-Recovery Techniques: A Review*, 2015.
- [197] Dewaele, *From P recovery to fertilizer production*, The second European Sustainable Phosphorus Conference materials, 2015.
- [198] Daginnus et al., *Best Available Techniques (BAT) Reference Document for the for Common Waste Gas Management and Treatment Systems in the Chemical Sector (WGC BREF)*, European Commission, Joint Research Centre, 2023.
- [199] EFSA, *Scientific opinion: Welfare of cattle at slaughter (EFSA Journal)*, 2019.
- [200] IAF, *International Accreditation Forum website*, 2010.
- [201] COM, *EMAS website https://ec.europa.eu/environment/emas/index_en.htm*, 2021.
- [202] COM, *EU, 'Regulation (EC) No 1221/2009 of the European Parliament and of the Council of 25 November 2009 on the voluntary participation by organisations in a Community ecomanagement and audit scheme (EMAS), repealing Regulation (EC) No 761/2001 and Commission Decisions 2001/681/EC and 2006/193/EC', Official Journal of the European Union, Vol. L 342, 22.12.2009, 2009, pp. 1-45, 2009.*
- [203] VDI, *Emission Control Plants for the Utilization and Disposal of Animal Carcasses, either Wholly or Partially, and for the Processing of Animal Products (Rendering Plants)*, VDI 2590, 1996.
- [204] TWG, *Comments on the first draft of the reviewed SA BREF*, 2021.
- [205] EFPRA, Personal communication, 2022.
- [206] TWG, *TWG comments to the revised draft BATc before the Final Meeting*, 2022.
- [207] TWG, *Information submitted after the Final Meeting*, 2023.
- [208] COM, *Commission Recommendation (EU) 2021/1749 of 28 September 2021 on Energy Efficiency First: from principles to practice — Guidelines and examples for its implementation in decision-making in the energy sector and beyond*, 2021.
- [209] COM, *proposal for a Directive of the European Parliament and of the Council on Energy Efficiency (recast) (COM/2021/558 final)*, 2021.
- [210] EEB, *Input for the technique 'Optimisation of design and operation of cooling system(s)'*, 2023.
- [211] TWG, *Comments to the pre-final Draft.*, 2023.
- [212] TWG, *Information submitted after the second data assessment workshop*, 2022.

GETTING IN TOUCH WITH THE EU

In person

All over the European Union there are hundreds of Europe Direct centres. You can find the address of the centre nearest you online (european-union.europa.eu/contact-eu/meet-us_en).

On the phone or in writing

Europe Direct is a service that answers your questions about the European Union. You can contact this service:

- by freephone: 00 800 6 7 8 9 10 11 (certain operators may charge for these calls),
- at the following standard number: +32 22999696,
- via the following form: european-union.europa.eu/contact-eu/write-us_en.

FINDING INFORMATION ABOUT THE EU

Online

Information about the European Union in all the official languages of the EU is available on the Europa website (european-union.europa.eu).

EU publications

You can view or order EU publications at op.europa.eu/en/publications. Multiple copies of free publications can be obtained by contacting Europe Direct or your local documentation centre (european-union.europa.eu/contact-eu/meet-us_en).

EU law and related documents

For access to legal information from the EU, including all EU law since 1951 in all the official language versions, go to EUR-Lex (eur-lex.europa.eu).

Open data from the EU

The portal data.europa.eu provides access to open datasets from the EU institutions, bodies and agencies. These can be downloaded and reused for free, for both commercial and non-commercial purposes. The portal also provides access to a wealth of datasets from European countries.

Science for policy

The Joint Research Centre (JRC) provides independent, evidence-based knowledge and science, supporting EU policies to positively impact society



EU Science Hub

joint-research-centre.ec.europa.eu



@EU_ScienceHub



EU Science Hub - Joint Research Centre



EU Science, Research and Innovation



EU Science Hub



@eu_science



Publications Office
of the European Union